



Stephen G. Kochan
Patrick Wood

Fourth Edition

Shell Programming

in Unix, Linux and OS X





An iconic symbol of the American West, **Monument Valley** is one of the natural wonders of the world. The red-sand desert region is located within the range of the Navajo Nation on the Arizona-Utah border and is host to towering sandstone rock formations that have been sculpted over time and soar 400 to 1,000 feet above the valley floor. Three of the valley's most photographed peaks are the distinctive East and West Mitten Buttes and Merrick Butte.

Shell Programming in Unix, Linux and OS X

Fourth Edition

Developer's Library

ESSENTIAL REFERENCES FOR PROGRAMMING PROFESSIONALS

Developer's Library books are designed to provide practicing programmers with unique, high-quality references and tutorials on the programming languages and technologies they use in their daily work.

All books in the *Developer's Library* are written by expert technology practitioners who are especially skilled at organizing and presenting information in a way that's useful for other programmers.

Key titles include some of the best, most widely acclaimed books within their topic areas:

PHP & MySQL Web Development
Luke Welling & Laura Thomson
ISBN-13: 978-0-321-83389-1

MySQL
Paul DuBois
ISBN-13: 978-0-672-32938-8

Linux Kernel Development
Robert Love
ISBN-13: 978-0-672-32946-3

Python Essential Reference
David Beazley
ISBN-13: 978-0-672-32862-6

Programming in Objective-C
Stephen G. Kochan
ISBN-13: 978-0-321-56615-7

Programming in C
Stephen G. Kochan
ISBN-13: 978-0-321-77641-9

Developer's Library books are available at most retail and online bookstores, as well as by subscription from Safari Books Online at safari.informit.com

**Developer's
Library**

informit.com/devlibrary

Shell Programming in Unix, Linux and OS X

Fourth Edition

Stephen G. Kochan
Patrick Wood

◆ Addison-Wesley

800 East 96th Street, Indianapolis, Indiana 46240

Shell Programming in Unix, Linux and OS X, Fourth Edition

Copyright © 2017 by Pearson Education, Inc.

All rights reserved. No part of this book shall be reproduced, stored in a retrieval system, or transmitted by any means, electronic, mechanical, photocopying, recording, or otherwise, without written permission from the publisher. No patent liability is assumed with respect to the use of the information contained herein. Although every precaution has been taken in the preparation of this book, the publisher and author assume no responsibility for errors or omissions. Nor is any liability assumed for damages resulting from the use of the information contained herein.

ISBN-13: 978-0-13-4449600-9

ISBN-10: 0-13-449600-0

Printed in the United States of America

First Printing: August 2016

The Library of Congress Control Number is on file.

Trademarks

All terms mentioned in this book that are known to be trademarks or service marks have been appropriately capitalized. The publisher cannot attest to the accuracy of this information. Use of a term in this book should not be regarded as affecting the validity of any trademark or service mark.

Warning and Disclaimer

Every effort has been made to make this book as complete and as accurate as possible, but no warranty or fitness is implied. The information provided is on an “as is” basis. The author and the publisher shall have neither liability nor responsibility to any person or entity with respect to any loss or damages arising from the information contained in this book.

Special Sales

For information about buying this title in bulk quantities, or for special sales opportunities (which may include electronic versions; custom cover designs; and content particular to your business, training goals, marketing focus, or branding interests), please contact our corporate sales department at corpsales@pearsoned.com or (800) 382-3419.

For government sales inquiries, please contact

governmentsales@pearsoned.com

For questions about sales outside the U.S., please contact

international@pearsoned.com

Editor

Mark Taber

Copy Editor

Larry Sulky

Technical Editor

Brian Tiemann

Designer

Chuti Prasertsith

Page Layout

codeMantra

Contents at a Glance

Introduction	1
1 A Quick Review of the Basics	5
2 What Is the Shell?	39
3 Tools of the Trade	51
4 And Away We Go	93
5 Can I Quote You on That?	105
6 Passing Arguments	121
7 Decisions, Decisions	131
8 'Round and 'Round She Goes	163
9 Reading and Printing Data	185
10 Your Environment	209
11 More on Parameters	239
12 Loose Ends	255
13 Rolo Revisited	273
14 Interactive and Nonstandard Shell Features	289
A Shell Summary	321
B For More Information	359
Index	363

Table of Contents

Introduction 1

How This Book Is Organized 2

Accessing the Free Web Edition 3

1 A Quick Review of the Basics 5

Some Basic Commands 5

Displaying the Date and Time: The `date` Command 5

Finding Out Who's Logged In: The `who` Command 5

Echoing Characters: The `echo` Command 6

Working with Files 6

Listing Files: The `ls` Command 7

Displaying the Contents of a File: The `cat` Command 7

Counting the Number of Words in a File: The `wc` Command 7

Command Options 8

Making a Copy of a File: The `cp` Command 8

Renaming a File: The `mv` Command 8

Removing a File: The `rm` Command 9

Working with Directories 9

The Home Directory and Pathnames 10

Displaying Your Working Directory: The `pwd` Command 12

Changing Directories: The `cd` Command 12

More on the `ls` Command 15

Creating a Directory: The `mkdir` Command 17

Copying a File from One Directory to Another 18

Moving Files Between Directories 19

Linking Files: The `ln` Command 20

Removing a Directory: The `rmdir` Command 23

Filename Substitution 24

The Asterisk 24

Matching Single Characters 25

Filename Nuances 27

Spaces in Filenames 27

Other Weird Characters 28

Standard Input/Output, and I/O Redirection 28

Standard Input and Standard Output 28

Output Redirection	30
Input Redirection	32
Pipes	33
Filters	35
Standard Error	35
More on Commands	36
Typing More Than One Command on a Line	36
Sending a Command to the Background	36
The <code>ps</code> Command	37
Command Summary	37
2 What Is the Shell?	39
The Kernel and the Utilities	39
The Login Shell	40
Typing Commands to the Shell	43
The Shell's Responsibilities	44
Program Execution	45
Variable and Filename Substitution	47
I/O Redirection	48
Hooking up a Pipeline	49
Environment Control	49
Interpreted Programming Language	50
3 Tools of the Trade	51
Regular Expressions	51
Matching Any Character: The Period (<code>.</code>)	51
Matching the Beginning of the Line: The Caret (<code>^</code>)	53
Matching the End of the Line: The Dollar Sign (<code>\$</code>)	53
Matching a Character Set: The <code>[...]</code> Construct	55
Matching Zero or More Characters: The Asterisk (<code>*</code>)	57
Matching a Precise Number of Subpatterns: <code>\{...\}</code>	59
Saving Matched Characters: <code>\(...\)</code>	61
<code>cut</code>	64
The <code>-d</code> and <code>-f</code> Options	66
<code>paste</code>	68
The <code>-d</code> Option	69
The <code>-s</code> Option	70

sed	70
The -n Option	72
Deleting Lines	73
tr	74
The -s Option	76
The -d Option	77
grep	78
Regular Expressions and grep	81
The -v Option	82
The -l Option	82
The -n Option	83
sort	84
The -u Option	84
The -r Option	85
The -o Option	85
The -n Option	86
Skipping Fields	87
The -t Option	87
Other Options	88
uniq	88
The -d Option	89
Other Options	90
4 And Away We Go	93
Command Files	93
Comments	96
Variables	97
Displaying the Values of Variables	98
Undefined Variables Have the Null Value	100
Filename Substitution and Variables	101
The $\${variable}$ Construct	102
Built-in Integer Arithmetic	103
5 Can I Quote You on That?	105
The Single Quote	105
The Double Quote	109
The Backslash	111

Using the Backslash for Continuing Lines	112
The Backslash Inside Double Quotes	112
Command Substitution	114
The Back Quote	114
The <code>\$(...)</code> Construct	115
The <code>expr</code> Command	119
6 Passing Arguments	121
The <code>\$#</code> Variable	122
The <code>\$*</code> Variable	123
A Program to Look Up Someone in the Phone Book	124
A Program to Add Someone to the Phone Book	125
A Program to Remove Someone from the Phone Book	127
<code>\${n}</code>	128
The <code>shift</code> Command	128
7 Decisions, Decisions	131
Exit Status	131
The <code>\$?</code> Variable	132
The <code>test</code> Command	135
String Operators	135
An Alternative Format for <code>test</code>	139
Integer Operators	140
File Operators	142
The Logical Negation Operator <code>!</code>	143
The Logical AND Operator <code>-a</code>	143
Parentheses	144
The Logical OR Operator <code>-o</code>	144
The <code>else</code> Construct	145
The <code>exit</code> Command	147
A Second Look at the <code>rem</code> Program	147
The <code>elif</code> Construct	148
Yet Another Version of <code>rem</code>	151
The <code>case</code> Command	153
Special Pattern-Matching Characters	155
The <code>-x</code> Option for Debugging Programs	157
Back to the <code>case</code>	159

The Null Command : 160
The `&&` and `||` Constructs 161

8 'Round and 'Round She Goes 163

The `for` Command 163
 The `$@` Variable 166
 The `for` Without the List 167
The `while` Command 168
The `until` Command 170
More on Loops 174
 Breaking Out of a Loop 174
 Skipping the Remaining Commands in a Loop 176
 Executing a Loop in the Background 177
 I/O Redirection on a Loop 177
 Piping Data into and out of a Loop 178
 Typing a Loop on One Line 179
The `getopts` Command 180

9 Reading and Printing Data 185

The `read` Command 185
 A Program to Copy Files 185
 Special `echo` Escape Characters 187
 An Improved Version of `mycp` 188
 A Final Version of `mycp` 190
 A Menu-Driven Phone Program 193
 The `$$` Variable and Temporary Files 198
 The Exit Status from `read` 199
The `printf` Command 202

10 Your Environment 209

Local Variables 209
 Subshells 210
Exported Variables 211
 `export -p` 215
PS1 and PS2 216
HOME 217
PATH 217

Your Current Directory	225
CDPATH	226
More on Subshells	227
The .Command	227
The exec Command	230
The (...) and { ...; } Constructs	231
Another Way to Pass Variables to a Subshell	234
Your .profile File	235
The TERM Variable	236
The TZ Variable	237

11 More on Parameters 239

Parameter Substitution	239
\${parameter}	239
\${parameter:-value}	240
\${parameter:=value}	241
\${parameter:?value}	241
\${parameter:+value}	242
Pattern Matching Constructs	242
\${#variable}	244
The \$0 Variable	245
The set Command	246
The -x Option	246
set with No Arguments	247
Using set to Reassign Positional Parameters	247
The -- Option	248
Other Options to set	251
The IFS Variable	251
The readonly Command	254
The unset Command	254

12 Loose Ends 255

The eval Command	255
The wait Command	257
The \$! Variable	257
The trap Command	258
trap with No Arguments	259

- Ignoring Signals 260
- Resetting Traps 261
- More on I/O 261
 - <&- and >&- 262
 - In-line Input Redirection 262
 - Shell Archives 264
- Functions 268
 - Removing a Function Definition 271
 - The `return` Command 271
- The `type` Command 271

13 Rolo Revisited 273

- Data Formatting Considerations 273
- `rolo` 274
- `add` 277
- `lu` 278
- `display` 278
- `rem` 280
- `change` 281
- `listall` 283
- Sample Output 284

14 Interactive and Nonstandard Shell Features 289

- Getting the Right Shell 289
- The ENV File 290
- Command-Line Editing 291
- Command History 292
- The `vi` Line Edit Mode 292
 - Accessing Commands from Your History 294
- The `emacs` Line Edit Mode 296
 - Accessing Commands from Your History 298
- Other Ways to Access Your History 300
 - The `history` Command 300
 - The `fc` Command 301
 - The `r` Command 301
- Functions 303
 - Local Variables 303
 - Automatically Loaded Functions 303

Integer Arithmetic	303
Integer Types	304
Numbers in Different Bases	305
The <code>alias</code> Command	307
Removing Aliases	309
Arrays	309
Job Control	315
Stopped Jobs and the <code>fg</code> and <code>bg</code> Commands	316
Miscellaneous Features	317
Other Features of the <code>cd</code> Command	317
Tilde Substitution	318
Order of Search	319
Compatibility Summary	319
A Shell Summary	321
Startup	321
Commands	321
Comments	322
Parameters and Variables	322
Shell Variables	322
Positional Parameters	322
Special Parameters	323
Parameter Substitution	324
Command Re-entry	326
The <code>fc</code> Command	326
<code>vi</code> Line Edit Mode	326
Quoting	329
Tilde Substitution	329
Arithmetic Expressions	330
Filename Substitution	331
I/O Redirection	331
Exported Variables and Subshell Execution	332
The <code>(...)</code> Construct	332
The <code>{ ...; }</code> Construct	332
More on Shell Variables	333
Functions	333
Job Control	333

Shell Jobs	333
Stopping Jobs	334
Command Summary	334
The : Command	334
The . Command	334
The alias Command	335
The bg Command	335
The break Command	336
The case Command	336
The cd Command	337
The continue Command	338
The echo Command	338
The eval Command	339
The exec Command	339
The exit Command	340
The export Command	340
The false Command	341
The fc Command	341
The fg Command	342
The for Command	342
The getopts Command	343
The hash Command	344
The if Command	344
The jobs Command	347
The kill Command	347
The newgrp Command	347
The pwd Command	348
The read Command	348
The readonly Command	349
The return Command	349
The set Command	350
The shift Command	352
The test Command	352
The times Command	354
The trap Command	355
The true Command	356
The type Command	356

The <code>umask</code> Command	356
The <code>unalias</code> Command	356
The <code>unset</code> Command	357
The <code>until</code> Command	357
The <code>wait</code> Command	358
The <code>while</code> Command	358
B For More Information	359
Online Documentation	359
Documentation on the Web	360
Books	360
O'Reilly & Associates	360
Pearson	361
Index	363

About the Authors

Stephen Kochan is the author or co-author of several best-selling titles on Unix and the C language, including *Programming in C*, *Programming in Objective-C*, *Topics in C Programming*, and *Exploring the Unix System*. He is a former software consultant for AT&T Bell Laboratories, where he developed and taught classes on Unix and C programming.

Patrick Wood is the CTO of the New Jersey location of Electronics for Imaging. He was a member of the technical staff at Bell Laboratories when he met Mr. Kochan in 1985. Together they founded Pipeline Associates, Inc., a Unix consulting firm, where he was vice president. They co-authored *Exploring the Unix System*, *Unix System Security*, *Topics in C Programming*, and *Unix Shell Programming*.

We Want to Hear from You!

As the reader of this book, *you* are our most important critic and commentator. We value your opinion and want to know what we're doing right, what we could do better, what areas you'd like to see us publish in, and any other words of wisdom you're willing to pass our way.

We welcome your comments. You can email or write directly to let us know what you did or didn't like about this book—as well as what we can do to make our books better.

Please note that we cannot help you with technical problems related to the topic of this book, and that due to the high volume of mail we receive, we might not be able to reply to every message.

When you write, please be sure to include this book's title and author, as well as your name and phone or email address.

Email: feedback@developers-library.info

Mail: Reader Feedback
Addison-Wesley Developer's Library
800 East 96th Street
Indianapolis, IN 46240 USA

Reader Services

Visit our website and register this book at www.informit.com/register for convenient access to any updates, downloads, or errata that might be available for this book.

This page intentionally left blank

Introduction

It's no secret that the family of Unix and Unix-like operating systems has emerged over the last few decades as the most pervasive, most widely used group of operating systems in computing today. For programmers who have been using Unix for many years, this came as no surprise: The Unix system provides an elegant and efficient environment for program development. That's exactly what Dennis Ritchie and Ken Thompson sought to create when they developed Unix at Bell Laboratories way back in the late 1960s.

Note

Throughout this book we'll use the term Unix to refer generically to the broad family of Unix-based operating systems, including true Unix operating systems such as Solaris as well as Unix-like operating systems such as Linux and Mac OS X.

One of the strongest features of the Unix system is its wide collection of programs. More than 200 basic commands are distributed with the standard operating system and Linux adds to it, often shipping with 700–1000 standard commands! These commands (also known as *tools*) do everything from counting the number of lines in a file, to sending electronic mail, to displaying a calendar for any desired year.

But the real strength of the Unix system comes not from its large collection of commands but from the elegance and ease with which these commands can be combined to perform far more sophisticated tasks.

The standard user interface to Unix is the command line, which actually turns out to be a *shell*, a program that acts as a buffer between the user and the lowest levels of the system itself (the *kernel*). The shell is simply a program that reads in the commands you type and converts them into a form more readily understood by the system. It also includes core programming constructs that let you make decisions, loop, and store values in variables.

The standard shell distributed with Unix systems derives from AT&T's distribution, which evolved from a version originally written by Stephen Bourne at Bell Labs. Since then, the IEEE has created standards based on the Bourne shell and the other more recent shells. The current version of this standard, as of this writing, is the Shell and Utilities volume of IEEE Std 1003.1-2001, also known as the POSIX standard. This shell is what we use as the basis for the rest of this book.

The examples in this book were tested on a Mac running Mac OS X 10.11, Ubuntu Linux 14.0, and an old version of SunOS 5.7 running on a Sparcstation Ultra-30. All examples, with the

exception of some Bash examples in Chapter 14, were run using the Korn shell, although all of them also work fine with Bash.

Because the shell offers an interpreted programming language, programs can be written, modified, and debugged quickly and easily. We turn to the shell as our first choice of programming language and after you become adept at shell programming, you will too.

How This Book Is Organized

This book assumes that you are familiar with the fundamentals of the system and command line; that is, that you know how to log in; how to create files, edit them, and remove them; and how to work with directories. In case you haven't used the Linux or Unix system for a while, we'll examine the basics in Chapter 1, "A Quick Review of the Basics." In addition, filename substitution, I/O redirection, and pipes are also reviewed in the first chapter.

Chapter 2, "What Is the Shell?," reveals what the shell really is, how it works, and how it ends up being your primary method of interacting with the operating system itself. You'll learn about what happens every time you log in to the system, how the shell program gets started, how it parses the command line, and how it executes other programs for you. A key point made in Chapter 2 is that the shell is just another program; nothing more, nothing less.

Chapter 3, "Tools of the Trade," provides tutorials on tools useful in writing shell programs. Covered in this chapter are `cut`, `paste`, `sed`, `grep`, `sort`, `tr`, and `uniq`. Admittedly, the selection is subjective, but it does set the stage for programs that we'll develop throughout the remainder of the book. Also in Chapter 3 is a detailed discussion of regular expressions, which are used by many Unix commands, such as `sed`, `grep`, and `ed`.

Chapters 4 through 9 teach you how to put the shell to work for writing programs. You'll learn how to write your own commands; use variables; write programs that accept arguments; make decisions; use the shell's `for`, `while`, and `until` looping commands; and use the `read` command to read data from the terminal or from a file. Chapter 5, "Can I Quote you on That?," is devoted entirely to a discussion of one of the most intriguing (and often confusing) aspects of the shell: the way it interprets quotes.

By that point in the book, all the basic programming constructs in the shell will have been covered, and you will be able to write shell programs to solve your particular problems.

Chapter 10, "Your Environment," covers a topic of great importance for a real understanding of the way the shell operates: the *environment*. You'll learn about local and exported variables; subshells; special shell variables, such as `HOME`, `PATH`, and `CDPATH`; and how to set up your `.profile` file.

Chapter 11, "More on Parameters," and Chapter 12, "Loose Ends," tie up some loose ends, and Chapter 13, "Rolo Revisited," presents a final version of a phone directory program called `rolo` that is developed throughout the book.

Chapter 14, “Interactive and Nonstandard Shell Features,” discusses features of the shell that either are not formally part of the IEEE POSIX standard shell (but are available in most Unix and Linux shells) or are mainly used interactively instead of in programs.

Appendix A, “Shell Summary,” summarizes the features of the IEEE POSIX standard shell.

Appendix B, “For More Information,” lists references and resources, including the Web sites where different shells can be downloaded.

The philosophy this book uses is to teach by example. We believe that properly chosen examples do a far better job of illustrating how a particular feature is used than ten times as many words. The old “A picture is worth ...” adage seems to apply just as well to coding.

We encourage you to type in each example and test it on your own system, for only by doing can you become adept at shell programming. Don’t be afraid to experiment. Try changing commands in the program examples to see the effect, or add different options or features to make the programs more useful or robust.

Accessing the Free Web Edition

Your purchase of this book in any format includes access to the corresponding Web Edition, which provides several special features to help you learn:

- The complete text of the book online
- Interactive quizzes and exercises to test your understanding of the material
- Updates and corrections as they become available

The Web Edition can be viewed on all types of computers and mobile devices with any modern web browser that supports HTML5.

To get access to the Web Edition of *Shell Programming with Unix, Linux, and OS X* all you need to do is register this book:

1. Go to www.informit.com/register.
2. Sign in or create a new account.
3. Enter ISBN: 9780134496009.
4. Answer the questions as proof of purchase.

The Web Edition will appear under the Digital Purchases tab on your Account page. Click the Launch link to access the product.

This page intentionally left blank

A Quick Review of the Basics

This chapter provides a review of the Unix system, including the file system, basic commands, filename substitution, I/O redirection, and pipes.

Some Basic Commands

Displaying the Date and Time: The `date` Command

The `date` command tells the system to print the date and time:

```
$ date
Thu Dec  3 11:04:09 MST 2015
$
```

`date` prints the day of the week, month, day, time (24-hour clock, the system's time zone), and year. Throughout the code examples in this book, whenever we use **boldface type like this**, it's to indicate what you, the user, type in. Normal face type like this is used to indicate what the Unix system prints. *Italic type* is used for comments in interactive sequences.

Every Unix command is submitted to the system with the pressing of the `Enter` key. `Enter` says that you are finished typing things in and are ready for the Unix system to do its thing.

Finding Out Who's Logged In: The `who` Command

The `who` command can be used to get information about all users currently logged in to the system:

```
$ who
pat      tty29    Jul 19 14:40
ruth     tty37    Jul 19 10:54
steve    tty25    Jul 19 15:52
$
```

Here, three users are logged in: `pat`, `ruth`, and `steve`. Along with each user ID is listed the `tty` number of that user and the day and time that user logged in. The `tty` number is a unique identification number the Unix system gives to each terminal or network device that a user is on when they log into the system.

The `who` command also can be used to get information about yourself:

```
$ who am i
pat      tty29   Jul 19 14:40
$
```

`who` and `who am i` are actually the same command: `who`. In the latter case, the `am` and `i` are *arguments* to the `who` command. (This isn't a good example of how command arguments work; it's just a curiosity of the `who` command.)

Echoing Characters: The `echo` Command

The `echo` command prints (or *echoes*) at the terminal whatever else you happen to type on the line (there are some exceptions to this that you'll learn about later):

```
$ echo this is a test
this is a test
$ echo why not print out a longer line with echo?
why not print out a longer line with echo?
$ echo
                                     A blank line is displayed
$ echo one           two   three           four five
one two three four five
$
```

You will notice from the preceding example that `echo` squeezes out extra blanks between words. That's because on a Unix system, the words are important while the blanks are only there to separate the words. Generally, the Unix system ignores extra blanks (you'll learn more about this in the next chapter).

Working with Files

The Unix system recognizes only three basic types of files: *ordinary* files, *directory* files, and *special* files. An ordinary file is just that: any file on the system that contains data, text, program instructions, or just about anything else. Directories, or folders, are described later in this chapter. Finally, as its name implies, a special file has a special meaning to the Unix system and is typically associated with some form of I/O.

A filename can be composed of just about any character directly available from the keyboard (and even some that aren't) provided that the total number of characters contained in the name is not greater than 255. If more than 255 characters are specified, the Unix system simply ignores the extra characters.

The Unix system provides many tools that make working with files easy. Here we'll review some of the basic file manipulation commands.

Listing Files: The `ls` Command

To see what files you have stored in your directory, you can type the `ls` command:

```
$ ls
READ_ME
names
tmp
$
```

This output indicates that three files called `READ_ME`, `names`, and `tmp` are contained in the current directory. (Note that the output of `ls` may vary from system to system. For example, on many Unix systems `ls` produces multicolumn output when sending its output to a terminal; on others, different colors may be used for different types of files. You can always force single-column output with the `-1` option—that's the number one.)

Displaying the Contents of a File: The `cat` Command

You can examine the *contents* of a file by using the `cat` command. (That's short for "concatenate," if you're thinking feline thoughts.) The argument to `cat` is the name of the file whose contents you want to examine.

```
$ cat names
Susan
Jeff
Henry
Allan
Ken
$
```

Counting the Number of Words in a File: The `wc` Command

With the `wc` command, you can get a count of the total number of lines, words, and characters contained in a file. Once again, the name of the file is expected to be specified as the argument to this command:

```
$ wc names
      5      7      27 names
$
```

The `wc` command lists three numbers followed by the filename. The first number represents the number of lines in the file (5), the second the number of words (7), and the third the number of characters (27).

Command Options

Most Unix commands allow the specification of *options* at the time a command is executed. These options generally follow the same format:

-letter

That is, a command option is a minus sign followed immediately by a single letter. For example, to count just the number of lines contained in a file, the option `-l` (that's the letter l) is given to the `wc` command:

```
$ wc -l names
    5 names
$
```

To count just the number of characters in a file, the `-c` option is specified:

```
$ wc -c names
   27 names
$
```

Finally, the `-w` option can be used to count the number of words contained in the file:

```
$ wc -w names
    7 names
$
```

Some commands require that the options be listed before the filename arguments. For example, `sort names -r` is acceptable, whereas `wc names -l` is not. Still, the former is unusual and most Unix commands are designed for you to specify command options first, as exemplified by `wc -l names`.

Making a Copy of a File: The `cp` Command

To make a copy of a file, use the `cp` command. The first argument to the command is the name of the file to be copied (known as the *source file*), and the second argument is the name of the file to place the copy into (known as the *destination file*). You can make a copy of the file `names` and call it `saved_names` as follows:

```
$ cp names saved_names
$
```

Execution of this command causes the contents of the file `names` to be copied into a new file named `saved_names`. As with many Unix commands, the fact that no output other than a command prompt was displayed after the `cp` command was typed indicates that the command executed successfully.

Renaming a File: The `mv` Command

A file can be renamed with the `mv` (“move”) command. The arguments to the `mv` command follow the same format as the `cp` command. The first argument is the name of the file to be

renamed, and the second argument is the new name. So, to change the name of the file `saved_names` to `hold_it`, for example, the following command would do the trick:

```
$ mv saved_names hold_it
$
```

Be careful! When executing an `mv` or `cp` command, the Unix system does not care whether the file specified as the second argument already exists. If it does, the contents of the file will be lost. For example, if a file called `old_names` exists, executing the command

```
cp names old_names
```

would copy the filenames to `old_names`, destroying the previous contents of `old_names` in the process. Similarly, the command

```
mv names old_names
```

would rename `names` to `old_names`, even if the file `old_names` existed prior to execution of the command.

Removing a File: The `rm` Command

Use the `rm` command to remove a file from the system. The argument to `rm` is simply the name of the file to be removed:

```
$ rm hold_it
$
```

You can remove more than one file at a time with the `rm` command by simply specifying all such files on the command line. For example, the following would remove the three files `wb`, `collect`, and `mon`:

```
$ rm wb collect mon
$
```

Working with Directories

Suppose that you had a set of files consisting of various memos, proposals, and letters. Further suppose that you had another set of files that were computer programs. It would seem logical to group this first set into a directory called `documents` and the latter into a directory called `programs`. Figure 1.1 illustrates such a directory organization.

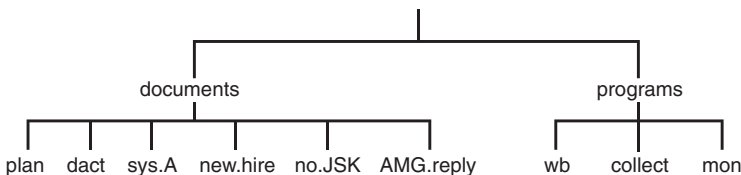

Figure 1.1 Example directory structure

The file directory `documents` contains the files `plan`, `dact`, `sys.A`, `new.hire`, `no.JSK`, and `AMG.reply`. The directory `programs` contains the files `wb`, `collect`, and `mon`. At some point, you may decide to further categorize the files in a directory. This can be done by creating subdirectories and then placing each file into the appropriate subdirectory. For example, you might want to create subdirectories called `memos`, `proposals`, and `letters` inside your `documents` directory, as shown in Figure 1.2.

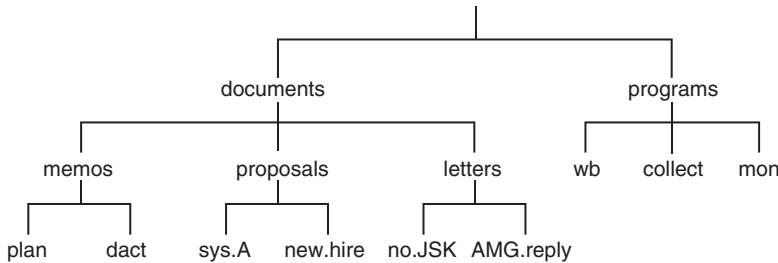

Figure 1.2 Directories containing subdirectories

`documents` contains the subdirectories `memos`, `proposals`, and `letters`. Each of these subdirectories in turn contains two files: `memos` contains `plan` and `dact`; `proposals` contains `sys.A` and `new.hire`; and `letters` contains `no.JSK` and `AMG.reply`.

Although each file in a given directory must have a unique name, files contained in different directories do not. So you could have a file in your `programs` directory called `dact`, even though a file by that name also exists in the `memos` subdirectory.

The Home Directory and Pathnames

The Unix system always associates each user of the system with a particular directory. When you log in to the system, you are placed automatically into your own directory (called your *home* directory).

Although the location of users' home directories can vary from one system to the next, let's assume that your home directory is called `steve` and that this directory is actually a subdirectory of a directory called `users`. Therefore, if you had the directories `documents` and `programs`, the overall directory structure would actually look something like Figure 1.3. A special directory named `/` (pronounced "slash") is shown at the top of the directory tree. This directory is known as the *root*.

Whenever you are "inside" a particular directory (called your *current working directory*), the files contained within that directory are immediately accessible, without specifying any path information. If you want to access a file from another directory, you can either first issue a command to "change" to the appropriate directory and then access the particular file, or you can specify the particular file by its *pathname*.

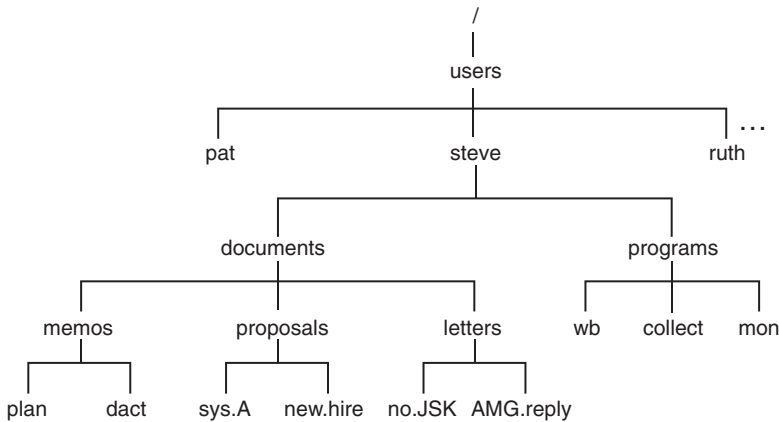

Figure 1.3 Hierarchical directory structure

A pathname enables you to uniquely identify a particular file to the Unix system. In the specification of a pathname, successive directories along the path are separated by the slash character `/`. A pathname that *begins* with a slash character is known as a *full* or *absolute* pathname because it specifies a complete path from the root. For example, the pathname `/users/steve` identifies the directory `steve` contained within the directory `users`. Similarly, the pathname `/users/steve/documents` references the directory `documents` as contained in the directory `steve` within `users`. As a final example, the pathname `/users/steve/documents/letters/AMG.reply` identifies the file `AMG.reply` contained along the appropriate directory path.

To help reduce the typing that would otherwise be required, Unix provides certain notational conveniences. A pathname that does not begin with a slash is known as a *relative* pathname: the path is relative to your current working directory. For example, if you just logged in to the system and were placed into your home directory `/users/steve`, you could directly reference the directory `documents` simply by typing `documents`. Similarly, the relative pathname `programs/mon` could be typed to access the file `mon` contained inside your `programs` directory.

By convention, `..` always references the directory that is one level higher than the current directory, known as the parent directory. For example, if you were in your home directory `/users/steve`, the pathname `..` would reference the directory `users`. If you had issued the appropriate command to change your working directory to `documents/letters`, the pathname `..` would reference the `documents` directory, `../..` would reference the directory `steve`, and `../proposals/new.hire` would reference the file `new.hire` contained in the `proposals` directory. There is usually more than one way to specify a path to a particular file, a very Unix-y characteristic.

Another notational convention is the single period `.`, which always refers to the current directory. That'll become more important later in the book when you want to specify a shell script in the current directory, not one in the `PATH`. We'll explain this in more detail soon.

Displaying Your Working Directory: The `pwd` Command

The `pwd` command is used to help you “get your bearings” by telling you the name of your current working directory.

Recall the directory structure from Figure 1.3. The directory that you are placed in after you log in to the system is called your home directory. You can assume from Figure 1.3 that the home directory for the user `steve` is `/users/steve`. Therefore, whenever `steve` logs in to the system, he will automatically be placed inside this directory. To verify that this is the case, the `pwd` (print working directory) command can be issued:

```
$ pwd
/users/steve
$
```

The output from the command verifies that `steve`'s current working directory is `/users/steve`.

Changing Directories: The `cd` Command

You can change your current working directory by using the `cd` command. This command takes as its argument the name of the target or destination directory.

Let's assume that you just logged in to the system and were placed in your home directory, `/users/steve`. This is depicted by the arrow in Figure 1.4.

You know that two directories are directly “below” `steve`'s home directory: `documents` and `programs`. This can be easily verified at the terminal by issuing the `ls` command:

```
$ ls
documents
programs
$
```

The `ls` command lists the two directories `documents` and `programs` the same way it listed other ordinary files in previous examples.

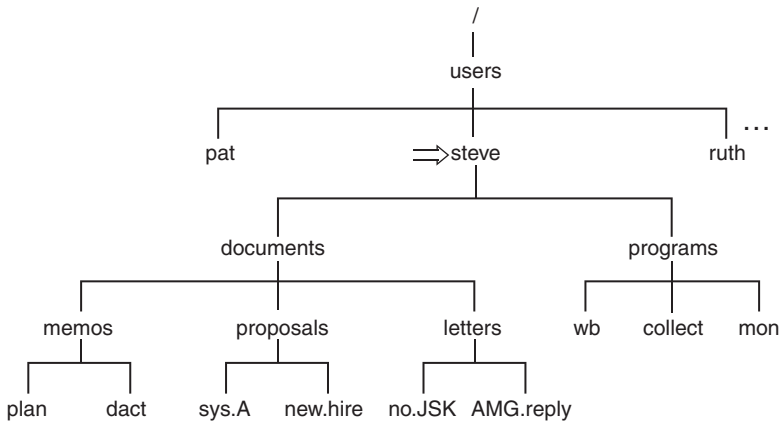
Figure 1.4 Current working directory is `steve`

To change your current working directory, issue the `cd` command, followed by the name of the new directory:

```
$ cd documents
$
```

After executing this command, you will be placed inside the `documents` directory, as depicted in Figure 1.5.

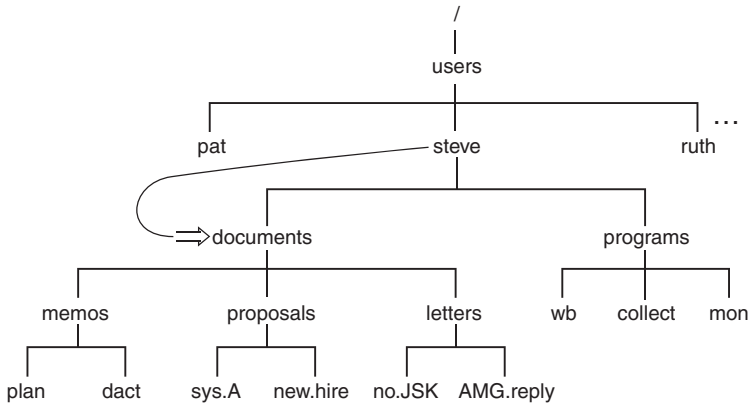
Figure 1.5 `cd documents`

You can verify at the terminal that the working directory has been changed by using the `pwd` command:

```
$ pwd
/users/steve/documents
$
```

The easiest way to move up one level in a directory is to reference the `..` shortcut with the command

```
cd ..
```

because by convention `..` always refers to the directory one level up (see Figure 1.6).

```
$ cd ..
$ pwd
/users/steve
$
```

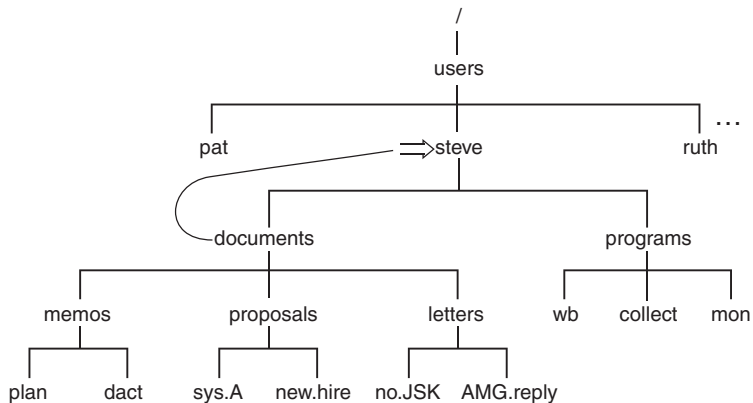
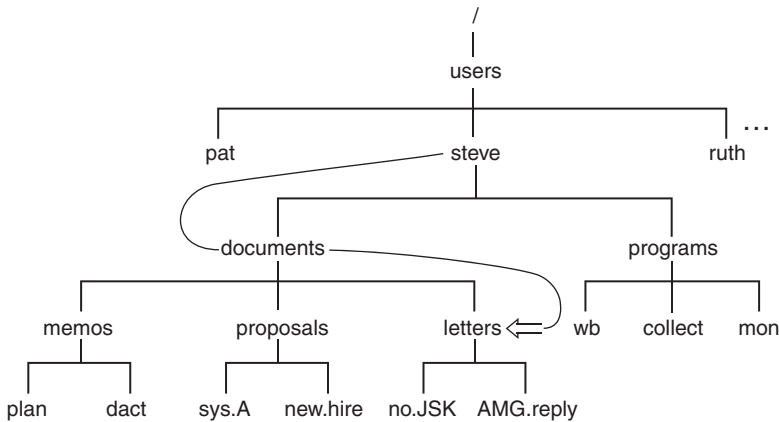

Figure 1.6 `cd ..`

If you wanted to change to the `letters` directory, you could get there with a single `cd` command by specifying the relative path `documents/letters` (see Figure 1.7):

```
$ cd documents/letters
$ pwd
/users/steve/documents/letters
$
```

Figure 1.7 `cd documents/letters`

You can get back up to your home directory by using a single `cd` command to go up two directories as shown:

```

$ cd ../../
$ pwd
/users/steve
$

```

Or you can get back to the home directory using a full pathname rather than a relative one:

```

$ cd /users/steve
$ pwd
/users/steve
$

```

Finally, there is a third way to get back to the home directory that is also the easiest. Typing the command `cd` *without* an argument *always* moves you back to your home directory, no matter where you are in the file system:

```

$ cd
$ pwd
/users/steve
$

```

More on the `ls` Command

When you type the `ls` command, the files contained in the current working directory are listed. But you can also use `ls` to obtain a list of files in other directories by supplying an argument to the command. First let's get back to your home directory:

```

$ cd
$ pwd
/users/steve
$

```

Now let's take a look at the files in the current working directory:

```
$ ls
documents
programs
$
```

If you supply the name of one of these directories to the `ls` command, you can get a list of the contents of that directory. So you can find out what's contained in the `documents` directory by typing the command `ls documents`:

```
$ ls documents
letters
memos
proposals
$
```

To take a look at the subdirectory `memos`, you can follow a similar procedure:

```
$ ls documents/memos
dact
plan
$
```

If you specify a nondirectory file argument to the `ls` command, you simply get that filename echoed back at the terminal:

```
$ ls documents/memos/plan
documents/memos/plan
$
```

Confused? There's an option to the `ls` command that lets you determine whether a particular file is a directory, among other things. The `-l` option (the letter `l`) provides a more detailed description of the files in a directory. If you were currently in `steve`'s home directory, here's what the `-l` option to the `ls` command produces:

```
$ ls -l
total 2
drwxr-xr-x  5 steve  DP3725   80 Jun 25 13:27 documents
drwxr-xr-x  2 steve  DP3725   96 Jun 25 13:31 programs
$
```

The first line of the display is a count of the total number of *blocks* (1,024 bytes) of storage that the listed files use. Each successive line displayed by the `ls -l` command contains detailed information about a file in the directory. The first character on each line indicates what type of file it is: `d` for a directory, `-` for a file, `b`, `c`, `l`, or `p` for a special file.

The next nine characters on the line define the access permissions of that particular file or directory. These *access modes* apply to the file's owner (the first three characters), other users in

the same *group* as the file's owner (the next three characters), and finally all other users on the system (the last three characters). Generally, they indicate whether the specified class of user can read the file, write to the file, or execute the contents of the file (in the case of a program or shell script).

The `ls -l` command then shows the *link* count (see “Linking Files: The `ln` Command,” later in this chapter), the owner of the file, the group owner of the file, how large the file is (that is, how many characters are contained in it), and when the file was last modified. The information displayed last on the line is the filename itself.

Note

Many modern Unix systems have gone away from using groups, so while those permissions are still shown, the group owner for a specific file or directory is often omitted in the output of the `ls` command.

You should now be able to glean a lot of information from the `ls -l` output for a directory full of files:

```
$ ls -l programs
total 4
-rwxr-xr-x  1 steve  DP3725   358 Jun 25 13:31 collect
-rwxr-xr-x  1 steve  DP3725  1219 Jun 25 13:31 mon
-rwxr-xr-x  1 steve  DP3725   89 Jun 25 13:30 wb
$
```

The dash in the first column of each line indicates that the three files `collect`, `mon`, and `wb` are ordinary files and not directories. Now, can you figure out how big are they?

Creating a Directory: The `mkdir` Command

Use `mkdir` to create directories. The argument to this command is simply the name of the directory you want to create. For example, assume that you are still working with the directory structure depicted in Figure 1.7 and that you want to create a new directory called `misc` *at the same level* as the directories `documents` and `programs`. If you were currently in your home directory, typing the command `mkdir misc` would achieve the desired effect:

```
$ mkdir misc
$
```

Now if you run `ls`, you will have the new directory listed:

```
$ ls
documents
misc
programs
$
```

The directory structure now appears as shown in Figure 1.8.

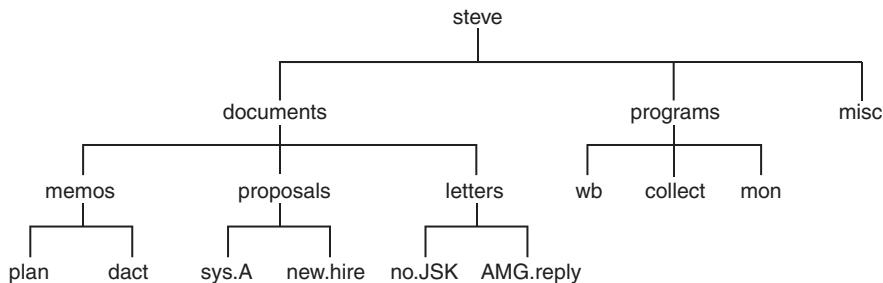

Figure 1.8 Directory structure with newly created `misc` directory

Copying a File from One Directory to Another

The `cp` command can be used to copy a file from one directory into another. For example, you can copy the file `wb` from the `programs` directory into a file called `wbx` in the `misc` directory as follows:

```
$ cp programs/wb misc/wbx
$
```

Because the two files are in different directories, they can safely have the exact same name:

```
$ cp programs/wb misc/wb
$
```

When the destination file is going to have the same name as the source file (in a different directory, of course), it is necessary to specify only the destination directory as the second argument:

```
$ cp programs/wb misc
$
```

When this command gets executed, the Unix system recognizes that the second argument is a directory and copies the source file into that directory. The new file is given the same name as the source file.

You can copy more than one file into a directory by listing the files to be copied prior to the name of the destination directory. If you were currently in the `programs` directory, the command

```
$ cp wb collect mon ../misc
$
```

would copy the three files `wb`, `collect`, and `mon` into the `misc` directory, with the same filenames.

To copy a file from another directory into your current location in the file system and give the file the same name, use the handy “.” shortcut for the current directory:

```
$ pwd
/users/steve/misc
$ cp ../programs/collect .
$
```

The preceding command copies the file `collect` from the directory `../programs` into the current directory (`/users/steve/misc`).

Moving Files Between Directories

You recall that the `mv` command can be used to rename a file. Indeed, there is no “rename” command in Unix. However, when the two arguments reference different directories, the file is actually moved from the first directory into the second.

To demonstrate, go from the home directory to the `documents` directory:

```
$ cd documents
$
```

Suppose that now you decide that the file `plan` contained in the `memos` directory is really a proposal so you want to move it from the `memos` directory into the `proposals` directory. The following would do the trick:

```
$ mv memos/plan proposals/plan
$
```

As with the `cp` command, if the source file and destination file have the same name, only the name of the destination directory need be supplied, so there’s an easier way to move this file:

```
$ mv memos/plan proposals
$
```

Also like the `cp` command, a group of files can be simultaneously moved into a directory by simply listing all files to be moved before the name of the destination directory:

```
$ pwd
/users/steve/programs
$ mv wb collect mon ../misc
$
```

This would move the three files `wb`, `collect`, and `mon` into the directory `misc`.

You can also use the `mv` command to change the name of a directory, as it happens. For example, the following renames the `programs` directory to `bin`.

```
$ mv programs bin
$
```

Linking Files: The `ln` Command

So far everything we've talked about with file management has assumed that a given collection of data has one and only one filename, wherever it may be located in the file system. It turns out that Unix is more sophisticated than that and can assign multiple filenames to the same collection of data.

The main command for creating these duplicate names for a given file is the `ln` command.

The general form of the command is

```
ln from to
```

This links the file *from* to the file *to*.

Recall the structure of *steve's programs* directory from Figure 1.8. In that directory, he has stored a program called *wb*. Suppose that he decides that he'd also like to call the program *writeback*. The most obvious thing to do would be to simply create a copy of *wb* called *writeback*:

```
$ cp wb writeback
$
```

The drawback with this approach is that now twice as much disk space is being consumed by the program. Furthermore, if *steve* ever changes *wb*, he may forget to duplicate the change in *writeback*, resulting in two different, out of sync copies of what he thinks is the same program. Not so good, Steve!

By linking the file *wb* to the new name, these problems are avoided:

```
$ ln wb writeback
$
```

Now instead of two copies of the file existing, only one exists with two different names: *wb* and *writeback*. The two files have been logically linked by the Unix system.

As far as you're concerned, it appears as though you have two *different* files. Executing an `ls` command shows the two files separately:

```
$ ls
collect
mon
wb
writeback
$
```

Where it gets interesting is when you use `ls -l`:

```
$ ls -l
total 5
-rwxr-xr-x  1 steve  DP3725    358 Jun 25 13:31 collect
-rwxr-xr-x  1 steve  DP3725   1219 Jun 25 13:31 mon
-rwxr-xr-x  2 steve  DP3725    89 Jun 25 13:30 wb
-rwxr-xr-x  2 steve  DP3725    89 Jun 25 13:30 writeback
$
```

Look closely at the second column of the output: The number shown is 1 for `collect` and `mon` and 2 for `wb` and `writeback`. This is the number of links to a file, normally 1 for nonlinked, nondirectory files. Because `wb` and `writeback` are linked, however, this number is 2 for these files (or, more correctly, this file with two names).

You can remove either of the two linked files at any time, and the other will not be removed:

```
$ rm writeback
$ ls -l
total 4
-rwxr-xr-x  1 steve  DP3725   358 Jun 25 13:31 collect
-rwxr-xr-x  1 steve  DP3725  1219 Jun 25 13:31 mon
-rwxr-xr-x  1 steve  DP3725    89 Jun 25 13:30 wb
$
```

Note that the number of links on `wb` went from 2 to 1 because one of its links was removed.

Most often, `ln` is used to allow a file to appear in more than one directory simultaneously. For example, suppose that `pat` wanted to have access to `steve`'s `wb` program. Instead of making a copy for himself (subject to the same data sync problems described previously) or including `steve`'s `programs` directory in his `PATH` (which has security risks as described in Chapter 10, "Your Environment"), he can simply link to the file from his own program directory:

```
$ pwd
/users/pat/bin
                                pat's program directory
$ ls -l
total 4
-rwxr-xr-x  1 pat    DP3822  1358 Jan 15 11:01 lcat
-rwxr-xr-x  1 pat    DP3822   504 Apr 21 18:30 xtr
$ ln /users/steve/wb .
                                link wb to pat's bin
$ ls -l
total 5
-rwxr-xr-x  1 pat    DP3822  1358 Jan 15 11:01 lcat
-rwxr-xr-x  2 steve  DP3725    89 Jun 25 13:30 wb
-rwxr-xr-x  1 pat    DP3822   504 Apr 21 18:30 xtr
$
```

Note that `steve` is still listed as the owner of `wb`, even when viewing the contents of `pat`'s directory. This makes sense, because there's really only one copy of the file and it's owned by `steve`.

The only stipulation on linking files is that for ordinary links the files to be linked together must reside on the same *file system*. If they don't, you'll get an error from `ln` when you try to link them. (To determine the different file systems on your system, execute the `df` command. The first field on each line of output is the name of a file system.)

To create links to files on different file systems (or on different networked systems), you can use the `-s` option to the `ln` command. This creates a *symbolic* link. Symbolic links behave a lot like regular links, except that the symbolic link points to the original file; if the original file is removed, the symbolic link no longer works.

Let's see how symbolic links work with the previous example:

```
$ rm wb
$ ls -l
total 4
-rwxr-xr-x  1 pat      DP3822   1358 Jan 15 11:01 lcat
-rwxr-xr-x  1 pat      DP3822    504 Apr 21 18:30 xtr
$ ln -s /users/steve/wb ./symwb           Symbolic link to wb
$ ls -l
total 5
-rwxr-xr-x  1 pat      DP3822   1358 Jan 15 11:01 lcat
lrwxr-xr-x  1 pat      DP3822    15 Jul 20 15:22 symwb -> /users/steve/wb
-rwxr-xr-x  1 pat      DP3822    504 Apr 21 18:30 xtr
$
```

Note that `pat` is listed as the owner of `symwb`, and the file type shown as the very first character in the `ls` output is `l`, which indicates a symbolic link. The size of the symbolic link is 15 (the file actually contains the string `/users/steve/wb`), but if we attempt to access the contents of the file, we are presented with the contents of the file it's linked to, `/users/steve/wb`:

```
$ wc symwb
      5      9      89 symwb
$
```

The `-L` option to the `ls` command can be used with the `-l` option to get a detailed list of information on the file the symbolic link points to:

```
$ ls -Ll
total 5
-rwxr-xr-x  1 pat      DP3822   1358 Jan 15 11:01 lcat
-rwxr-xr-x  2 steve   DP3725    89 Jun 25 13:30 wb
-rwxr-xr-x  1 pat      DP3822    504 Apr 21 18:30 xtr
$
```

Removing the file that a symbolic link points to invalidates the symbolic link (because symbolic links are maintained as filenames), but it doesn't remove it:

```
$ rm /users/steve/wb           Assume pat can remove this file
$ ls -l
total 5
-rwxr-xr-x  1 pat      DP3822   1358 Jan 15 11:01 lcat
lrwxr-xr-x  1 pat      DP3822    15 Jul 20 15:22 wb -> /users/steve/wb
-rwxr-xr-x  1 pat      DP3822    504 Apr 21 18:30 xtr
$ wc wb
Cannot open wb: No such file or directory
$
```

This type of file is called a *dangling symbolic link* and should be removed unless you have a specific reason to keep it around (for example, if you intend to replace the removed file).

One last note before leaving this discussion: The `ln` command follows the same general format as `cp` and `mv`, meaning that you can create links to a bunch of files within a specific target directory using the format

```
ln files directory
```

Removing a Directory: The `rmdir` Command

You can remove a directory with the `rmdir` command. Rather than let you accidentally remove dozens or hundreds of files, however, `rmdir` won't let you proceed unless the specified directory is completely empty of files and subdirectories.

To remove the directory `/users/pat`, we could use the following:

```
$ rmdir /users/pat
rmdir: pat: Directory not empty
$
```

Phew! That would have been a mistake! Instead, let's remove the `misc` directory that you created earlier:

```
$ rmdir /users/steve/misc
$
```

Once again, the preceding command works only if no files or directories are contained in the `misc` directory; otherwise, the following happens, as also shown earlier:

```
$ rmdir /users/steve/misc
rmdir: /users/steve/misc: Directory not empty
$
```

If you still want to remove the `misc` directory, you would first have to remove all the files contained in that directory before reissuing the `rmdir` command.

As an alternative method for removing a directory and its contents, you can use the `-r` option to the `rm` command. The format is simple:

```
rm -r dir
```

where `dir` is the name of the directory that you want to remove. `rm` removes the indicated directory and *all* files (including directories) in it, so be careful with this powerhouse command.

Want to go full turbo? Add the `-f` flag and it forces the action without prompting you on a command-by-command basis. It can completely trash your system if you're not careful, however, so many admins simply avoid `rm -rf` entirely!

Filename Substitution

The Asterisk

One powerful feature of the Unix system that is handled by the shell is *filename substitution*. Let's say that your current directory has these files in it:

```
$ ls
chapt1
chapt2
chapt3
chapt4
$
```

Suppose that you want to display their contents en masse. Easy: `cat` allows you to display the contents of as many files as you specify on the command line. Like this:

```
$ cat chapt1 chapt2 chapt3 chapt4
...
$
```

But that's tedious. Instead, you can take advantage of filename substitution by simply typing:

```
$ cat *
...
$
```

The shell automatically *substitutes* the names of all the files in the current directory that match the pattern `*`. The same substitution occurs if you use `*` with another command too, of course. How about `echo`?

```
$ echo *
chapt1 chapt2 chapt3 chapt4
$
```

Here the `*` is again replaced with the names of all the files contained in the current directory, and the `echo` command simply displays that list to you.

Any place that `*` appears on the command line, the shell performs its substitution:

```
$ echo * : *
chapt1 chapt2 chapt3 chapt4 : chapt1 chapt2 chapt3 chapt4
$
```

The `*` is part of a rich file substitution language, actually, and it can also be used in combination with other characters to limit which filenames are matched.

For example, let's say that in your current directory you have not only `chapt1` through `chapt4` but also files `a`, `b`, and `c`:

```
$ ls
a
b
```

```
c
chapt1
chapt2
chapt3
chapt4
$
```

To display the contents of just the files beginning with `chap`, you can type in

```
$ cat chap*
.
.
.
$
```

The `chap*` matches any filename that *begins* with `chap`. All such filenames matched are substituted on the command line before the specified command is even invoked.

The `*` is not limited to the end of a filename; it can be used at the beginning or in the middle as well:

```
$ echo *t1
chapt1
$ echo *t*
chapt1 chapt2 chapt3 chapt4
$ echo *x
*x
$
```

In the first `echo`, the `*t1` specifies all filenames that end in the characters `t1`. In the second `echo`, the first `*` matches everything up to a `t` and the second everything after; thus, all filenames containing a `t` are printed. Because there are no files ending with `x`, no substitution occurs in the last case. Therefore, the `echo` command simply displays `*x`.

Matching Single Characters

The asterisk (`*`) matches *zero* or more characters, meaning that `x*` matches the file `x` as well as `x1`, `x2`, `xabc`, and so on. The question mark (`?`) matches exactly one character. So `cat?` will display all files that have filenames of exactly one character, just as `cat x?` prints all files with two-character names beginning with `x`. Here we see this behavior illustrated again with `echo`:

```
$ ls
a
aa
aax
alice
b
bb
c
cc
```

```

report1
report2
report3
$ echo ?
a b c
$ echo a?
aa
$ echo ??
aa bb cc
$ echo ??*
aa aax alice bb cc report1 report2 report3
$

```

In the preceding example, the `??` matches two characters, and the `*` matches zero or more characters up to the end. The net effect is to match all filenames of two or more characters.

Another way to match a single character is to give a list of characters to match within square brackets `[]`. For example, `[abc]` matches the letter `a`, `b`, or `c`. It's similar to the `?`, but it allows you to choose which characters are valid matches.

You can also specify a logical range of characters with a dash, a huge convenience! For example, `[0-9]` matches the characters *0 through 9*. The only restriction in specifying a *range* of characters is that the first character must be alphabetically less than the last character, so that `[z-f]` is not a valid range specification, while `[f-z]` is.

By mixing and matching ranges and characters in the list, you can perform complicated substitutions. For example, `[a-np-z]*` matches all files that start with the letters `a` through `n` or `p` through `z` (or more simply stated, any filename that doesn't start with the lowercase letter `o`).

If the first character following the `[` is a `!`, the sense of the match is inverted. That is, any character is matched *except* those enclosed in the brackets. So

```
[!a-z]
```

matches any character except a lowercase letter, and

```
*[!o]
```

matches any file that doesn't end with the lowercase letter `o`.

Table 1.1 gives a few more examples of filename substitution.

Table 1.1 Filename Substitution Examples

Command	Description
<code>echo a*</code>	Print the <i>names</i> of the files beginning with <code>a</code>
<code>cat *.c</code>	Print the contents of all files ending in <code>.c</code>
<code>rm *.*</code>	Remove all files containing a period
<code>ls x*</code>	List the names of all files beginning with <code>x</code>

<code>rm *</code>	Remove <i>all</i> files in the current directory (No??? Be careful when you use this.)
<code>echo a*b</code>	Print the names of all files beginning with <code>a</code> and ending with <code>b</code>
<code>cp ../programs/* .</code>	Copy all files from <code>../programs</code> into the current directory
<code>ls [a-z]*[!0-9]</code>	List files that begin with a lowercase letter and don't end with a digit

Filename Nuances

Spaces in Filenames

A discussion of command lines and filenames wouldn't be complete without talking about the bane of old-school Unix people and very much the day-to-day reality of Linux, Windows, and Mac users: spaces in filenames.

The problem arises from the fact that the shell uses spaces as delimiters between words. In other words the phrase `echo hi mom` is properly parsed as an invocation to the command `echo`, with two arguments `hi` and `mom`.

Now imagine you have a file called `my test document`. How do you reference it from the command line? How do you view it or display it using the `cat` command?

```
$ cat my test document
cat: my: No such file or directory
cat: test: No such file or directory
cat: document: No such file or directory
```

That definitely doesn't work. Why? Because `cat` wants a filename to be specified and instead of seeing one, it sees three: `my`, `test`, and `document`.

There are two standard solutions for this: Either escape every space by using a backslash, or wrap the entire filename in quotes so that the shell understands that it's a single word with spaces, rather than multiple words.

```
$ cat "my test document"
This is a test document and is full
of scintillating information to edify
and amaze.

$ cat my\ test\ document
This is a test document and is full
of scintillating information to edify
and amaze.
```

That solves the problem and is critical to know as you proceed with file systems that quite likely have lots of directories and files that contain spaces as part of their filenames.

Other Weird Characters

While the space might be the most difficult and annoying of special characters that can appear in filenames, occasionally you'll find others show up that can throw a proverbial monkey-wrench into your command line efforts.

For example, how would you deal with a filename that contains a question mark? In the next section, you'll learn that the character "?" has a specific meaning to the shell. Most modern shells are smart enough to sidestep the duplication of meaning, but, again, quoting the filename or using backslashes to denote that the special character is part of the filename is required:

```
$ ls -l who\ me\?
-rw-r--r-- 1 taylor staff 0 Dec 4 10:18 who me?
```

Where this really gets interesting is if you have a backslash or quote as part of the filename, something that can happen inadvertently, particularly for files created by graphically oriented programs on a Linux or Mac system. The trick? Use single quotes to escape a filename that includes a double quote, and vice versa. Like this:

```
$ ls -l "don't quote me" 'She said "yes"'
-rw-r--r-- 1 taylor staff 0 Dec 4 10:18 don't quote me
-rw-r--r-- 1 taylor staff 0 Dec 4 10:19 She said "yes"
```

This topic will come up again as we proceed, but now you know how to side-step problems with directories or files that contain spaces or other non-standard characters.

Standard Input/Output, and I/O Redirection

Standard Input and Standard Output

Most Unix system commands take input from your screen and send the resulting output back to your screen. In Unix nomenclature, the screen is generally called the *terminal*, a reference that harkens back to the earliest days of computing. Nowadays it's more likely to be a terminal *program* you're running within a graphical environment, whether it's a Linux window manager, a Windows computer, or a Mac system.

A command normally reads its input from *standard input*, which is your computer keyboard by default. It's a fancy way of clarifying that you "type in" your information. Similarly, a command normally writes its output to *standard output*, which is also your terminal or terminal app by default. This concept is depicted in Figure 1.9.

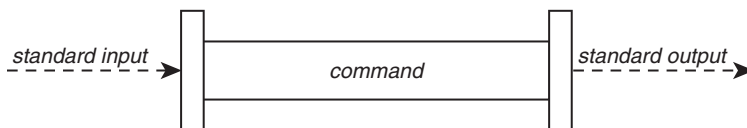

Figure 1.9 Typical Unix command

As an example, recall that executing the `who` command results in the display of all users that are currently logged-in. More formally, the `who` command writes a list of the logged-in users to standard output. This is depicted in Figure 1.10.

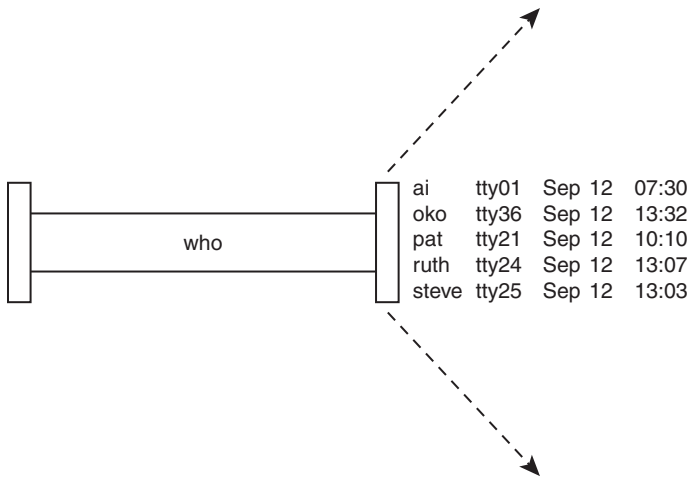

Figure 1.10 `who` command

It turns out that just about every single Unix command can take the output of a previous command or file as its input too, and can even send its output to another command or program. This concept is hugely important to understanding the power of the command line and why it's so helpful to know all of these commands even when a graphical interface might be also available for your use.

Before we get there, however, consider this: if the `sort` command is invoked *without* a filename argument, the command takes its input from standard input. As with standard output, this is your terminal (or keyboard) by default.

When input is entered this way, an end-of-file sequence must be specified after the last line is typed, and, by Unix convention, that's `Ctrl+d`; that is, the sequence produced by simultaneously pressing the *Control* (or *Ctrl*, depending on your keyboard) key and the *d* key.

As an example, let's use the `sort` command to sort the following four names: Tony, Barbara, Harry, Dirk. Instead of first entering the names into a file, we'll enter them directly from the terminal:

```
$ sort
Tony
Barbara
Harry
Dirk
Ctrl+d
```

```

Barbara
Dirk
Harry
Tony
$

```

Because no filename was specified to the `sort` command, the input was taken from standard input, the terminal. After the fourth name was typed in, the `Ctrl` and `d` keys were pressed to signal the end of the data. At that point, the `sort` command sorted the four names and displayed the results on the standard output device, which is also the terminal. This is depicted in Figure 1.11.

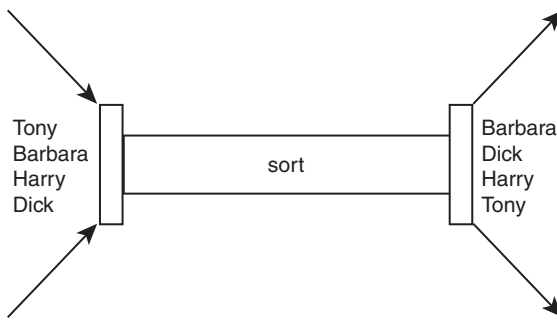

Figure 1.11 `sort` command

The `wc` command is another example of a command that takes its input from standard input if no filename is specified on the command line. The following shows an example of this command used to count the number of lines of text entered from the terminal:

```

$ wc -l
This is text that
is typed on the
standard input device.
Ctrl+d
  3
$

```

Note that the `Ctrl+d` that is used to terminate the input is not counted as a separate line by the `wc` command because it's interpreted by the shell, not handed to the command. Furthermore, because the `-l` flag was specified to the `wc` command, only the count of the number of lines (3) is presented as the output of the command.

Output Redirection

The output from a command normally intended for standard output can be easily “diverted” to a file instead. This capability is known as *output redirection* and is also essential to understanding the power of Unix.

If the notation `> file` is appended to *any* command that normally writes its output to standard output, the output of that command will be written to the file *file* instead:

```
$ who > users
$
```

This command causes the `who` command to be executed and its output to be written into the file `users`. Notice that no output appears. This is because the output has been *redirected* from the default standard output device (the terminal) into the specified file. We can check this, of course:

```
$ cat users
oko   tty01  Sep 12 07:30
ai    tty15  Sep 12 13:32
ruth  tty21  Sep 12 10:10
pat   tty24  Sep 12 13:07
steve tty25  Sep 12 13:03
$
```

If a command has its output redirected to a file and the file already contains some data, that data will be overwritten and lost.

```
$ echo line 1 > users
$ cat users
line 1
$
```

But now consider this example, remembering that `users` already contains the output of the earlier `who` command:

```
$ echo line 2 >> users
$ cat users
line 1
line 2
$
```

If you're paying close attention you'll notice that this `echo` command uses a different type of output redirection, indicated by the characters `>>`. This character pair causes the standard output from the command to be *appended* to the contents of the specified file. The previous contents are not lost; the new output simply gets added to the end.

By using the redirection append characters `>>`, you can use `cat` to append the contents of one file onto the end of another:

```
$ cat file1
This is in file1.
$ cat file2
This is in file2.
$ cat file1 >> file2
$ cat file2
This is in file2.
This is in file1.
$
```

Append file1 to file2

Recall that specifying more than one filename to `cat` results in the display of the first file followed immediately by the second file, and so on. This means there's a second way to accomplish the same result:

```
$ cat file1
This is in file1.
$ cat file2
This is in file2.
$ cat file1 file2
This is in file1.
This is in file2.
$ cat file1 file2 > file3           Redirect it instead
$ cat file3
This is in file1.
This is in file2.
$
```

In fact, that's where the `cat` command gets its name: When used with more than one file, its effect is to *concatenate* the files together.

Input Redirection

Just as the output of a command can be redirected to a file, so can the input of a command be redirected *from* a file. And as the greater-than character `>` is used for output redirection, the less-than character `<` is used to redirect the input of a command. Of course, only commands that normally take their input from standard input can have their input redirected from a file in this manner.

To redirect input, type the `<` character followed by the name of the file that the input is to be read from. To count the number of lines in the file `users`, for example, you already know that you can execute the command `wc -l users`:

```
$ wc -l users
   2 users
$
```

It turns out that you can also count the number of lines in the file by redirecting standard input for the `wc` command:

```
$ wc -l < users
   2
$
```

Note that there is a difference in the output produced by the two forms of the `wc` command. In the first case, the name of the file `users` is listed with the line count; in the second case, it is not.

This points out a subtle distinction between the execution of the two commands. In the first case, `wc` knows that it is reading its input from the file `users`. In the second case, it only sees the raw data which is being fed to it via standard input. The shell redirects the input so that it comes from the file `users` and not the terminal (more about this in the next chapter). As far as `wc` is concerned, it doesn't know whether its input is coming from the terminal or from a file, so it can't report the filename!

Pipes

As you will recall, the file `users` that was created previously contains a list of all the users currently logged in to the system. Because you know that there will be one line in the file for each user logged in to the system, you can easily determine the *number* of login sessions by counting the number of lines in the `users` file:

```
$ who > users
$ wc -l < users
    5
$
```

This output indicates that currently five users are logged in or that there are five login sessions, the difference being that users, particularly administrators, often log in more than once. Now you have a command sequence you can use whenever you want to know how many users are logged in.

Another approach to determine the number of logged-in users bypasses the intermediate file. As referenced earlier, Unix lets you “connect” two commands together. This connection is known as a *pipe*, and it enables you to take the output from one command and feed it directly into the input of another. A pipe is denoted by the character `|`, which is placed between the two commands. To create a pipe between the `who` and `wc -l` commands, you type

```
who | wc -l:
$ who | wc -l
    5
$
```

The pipe that is created between these two commands is depicted in Figure 1.12.

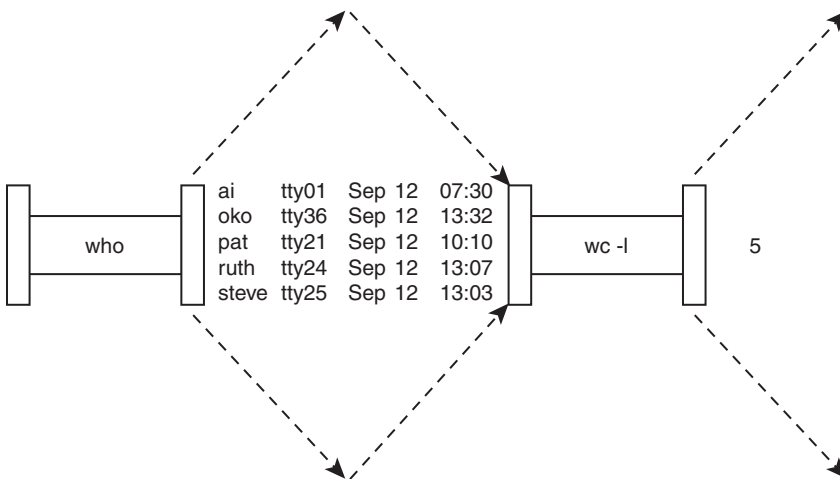

Figure 1.12 Pipeline process: `who | wc -l`

When a pipe is established between two commands, the standard output from the first command is connected directly to the standard input of the second command. You know that the `who` command writes its list of logged-in users to standard output. Furthermore, you know that if no filename argument is specified to the `wc` command, it takes its input from standard input. Therefore, the list of logged-in users that is output from the `who` command automatically becomes the input to the `wc` command. Note that you never see the output of the `who` command at the terminal because it is piped directly into the `wc` command. This is depicted in Figure 1.13.

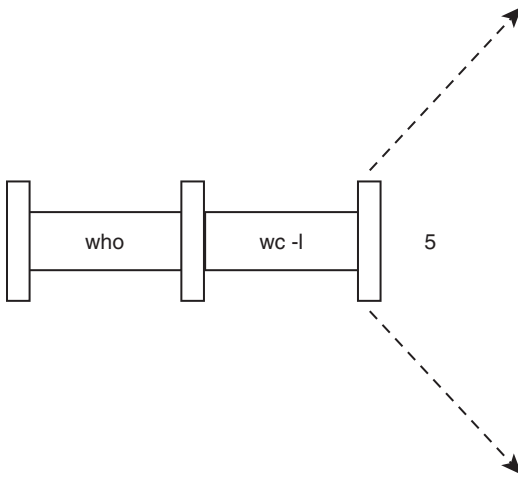

Figure 1.13 Pipeline process

A pipe can be made between *any* two programs, provided that the first program writes its output to standard output, and the second program reads its input from standard input.

As another example, suppose you wanted to count the number of files contained in your directory. Knowledge of the fact that the `ls` command displays one line of output per file enables you to use the same type of approach as before:

```
$ ls | wc -l
    10
$
```

The output indicates that the current directory contains 10 files.

It is also possible to create a more complicated *pipeline* that consists of more than two programs, with the output of one program feeding into the input of the next. As you become a more sophisticated command line user, you'll find many situations where pipelines can be tremendously powerful.

Filters

The term *filter* is often used in Unix terminology to refer to any program that can take input from standard input, perform some operation on that input, and write the results to standard output. More succinctly, a filter is any program that can be used to modify the output of other programs in a pipeline. So in the pipeline in the previous example, `wc` is considered a filter. `ls` is not because it does not read its input from standard input. As other examples, `cat` and `sort` are filters, whereas `who`, `date`, `cd`, `pwd`, `echo`, `rm`, `mv`, and `cp` are not.

Standard Error

In addition to standard input and standard output, there is a third virtual device known as *standard error*. This is where most Unix commands write their error messages. And as with the other two “standard” places, standard error is associated with your terminal or terminal app by default. In most cases, you never know the difference between standard output and standard error:

```
$ ls n* List all files beginning with n
n* not found
$
```

Here the “not found” message is actually being written to standard error by the `ls` command. You can verify that this message is not being written to standard output by redirecting the `ls` command’s output:

```
$ ls n* > foo
n* not found
$
```

As you can see, the message is still printed out at the terminal and was not added to the file `foo`, even though you redirected standard output.

The preceding example shows the *raison d’être* for standard error: so that error messages will still get displayed at the terminal even if standard output is redirected to a file or piped to another command.

You can also redirect standard error to a file (for instance, if you’re logging a program’s potential errors during long-term operation) by using the slightly more complex notation

```
command 2> file
```

Note that *no space is permitted* between the `2` and the `>`. Any error messages normally intended for standard error will be diverted into the specified *file*, similar to the way standard output gets redirected.

```
$ ls n* 2> errors
$ cat errors
n* not found
$
```

More on Commands

Typing More Than One Command on a Line

You can type more than one command on a line provided that you separate them with a semicolon. For example, you can find out the current time and your current working directory by typing in the `date` and `pwd` commands on the same line:

```
$ date; pwd
Sat Jul 20 14:43:25 EDT 2002
/users/pat/bin
$
```

You can string out as many commands as you want on the line, as long as each command is delimited by a semicolon.

Sending a Command to the Background

Normally, you type in a command and then wait for the results of the command to be displayed at the terminal. For all the examples you have seen thus far, this waiting time is typically short—a fraction of a second.

Sometimes, however, you may have to run commands that require a few minutes or longer to complete. In those cases, you'll have to wait for the command to finish executing before you can proceed further, *unless you execute the command in the background*.

It turns out that while your Unix or Linux system seems like it's focused completely on what you're doing, all systems are actually multitasking, running multiple commands simultaneously at any given time. If you're on an Ubuntu system, for example, it might have the window manager, a clock, a status monitor and your terminal window all running simultaneously. You too can run multiple commands simultaneously from the command line. That's the idea of putting a command "into background," letting you work on other tasks while it completes.

The notational convention for pushing a command or command sequence into background is to append the ampersand character `&`. This means that the command will no longer tie up your terminal, and you can then proceed with other work. The standard *output* from the command will still be directed to your terminal, though in most cases the standard *input* will be dissociated from your terminal. If the command does try to read from standard input, it will stop and wait for you to bring it to the foreground (we'll discuss this in more detail in Chapter 14, "Interactive and Nonstandard Shell Features").

Here's an example:

```
$ sort bigdata > out &          Send the sort to the background
[1] 1258                        Process id
$ date                          Your terminal is immediately available to do other work
Sat Jul 20 14:45:09 EDT 2002
$
```

When a command is sent to the background, the Unix system automatically displays two numbers. The first is called the command's *job number* and the second the *process ID*, or *PID*. In the preceding example, 1 is the job number and 1258 the process ID. The job number is used as a shortcut for referring to a specific background job by some shell commands. (You'll learn more about this in Chapter 14.) The process ID uniquely identifies the command that you sent to the background and can be used to obtain status information about the command. This is done with the processor status—`ps`—command.

The `ps` Command

The `ps` command gives you information about the processes running on the system. Without any options, it prints the status of just your processes. If you type in `ps` at your terminal, you'll get a few lines back describing the processes you have running:

```
$ ps
  PID TTY          TIME CMD
 13463 pts/16    00:00:09 bash
 19880 pts/16    00:00:00 ps
$
```

The `ps` command (typically; your system might vary) prints out four columns of information: `PID`, the process ID; `TTY`, the terminal number that the process was run from; `TIME`, the amount of computer time in minutes and seconds that process has used; and `CMD`, the name of the process. (The `bash` process in the preceding example is the shell that was started when we logged in, and it's used 9 seconds of computer time.) Until the command is finished, it shows up in the output of the `ps` command as a running process, so process 19880 in the preceding example is the `ps` command itself.

When used with the `-f` option, `ps` prints out more information about your processes, including the *parent* process ID (`PPID`), the time the process started (`STIME`), and the command arguments:

```
$ ps -f
  UID          PID    PPID  C  STIME TTY          TIME CMD
  steve      13463  13355  0  12:12 pts/16    00:00:09 bash
  steve      19884  13463  0  13:39 pts/16    00:00:00 ps -f
$
```

Command Summary

Table 1.2 summarizes the commands reviewed in this chapter. In this table, *file* refers to a file, *file(s)* to one or more files, *dir* to a directory, and *dir(s)* to one or more directories.

Table 1.2 Command Summary

Command	Description
<code>cat file(s)</code>	Display contents of <i>file(s)</i> or standard input if not supplied
<code>cd dir</code>	Change working directory to <i>dir</i>
<code>cp file₁ file₂</code>	Copy <i>file₁</i> to <i>file₂</i>
<code>cp file(s) dir</code>	Copy <i>file(s)</i> into <i>dir</i>
<code>date</code>	Display the date and time
<code>echo args</code>	Display <i>args</i>
<code>ln file₁ file₂</code>	Link <i>file₁</i> to <i>file₂</i>
<code>ln file(s) dir</code>	Link <i>file(s)</i> into <i>dir</i>
<code>ls file(s)</code>	List <i>file(s)</i>
<code>ls dir(s)</code>	List files in <i>dir(s)</i> or in current directory if <i>dir(s)</i> is not specified
<code>mkdir dir(s)</code>	Create directory <i>dir(s)</i>
<code>mv file₁ file₂</code>	Move <i>file₁</i> to <i>file₂</i> (simply rename it if both reference the same directory)
<code>mv file(s) dir</code>	Move <i>file(s)</i> into directory <i>dir</i>
<code>ps</code>	List information about active processes
<code>pwd</code>	Display current working directory path
<code>rm file(s)</code>	Remove <i>files(s)</i>
<code>rmdir dir(s)</code>	Remove empty directory <i>dir(s)</i>
<code>sort file(s)</code>	Sort lines of <i>file(s)</i> or standard input if <i>file(s)</i> not supplied
<code>wc file(s)</code>	Count the number of lines, words, and characters in <i>file(s)</i> or standard input if <i>file(s)</i> not supplied
<code>who</code>	Display who's logged in

What Is the Shell?

In this chapter you'll learn what the Unix command shell is, what it does and why it's a vital part of every power user's toolbox.

The Kernel and the Utilities

The Unix system is logically divided into two different areas: the *kernel* and the *utilities* (see Figure 2.1). Or, if you prefer, the kernel and everything else, generally all accessed through the shell.

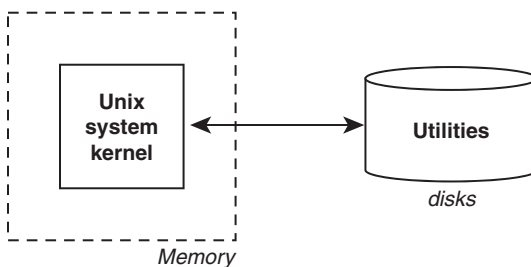

Figure 2.1 The Unix system

The kernel is the heart of the Unix system and resides in the computer's memory from the time the computer is turned on and *booted* until the time it is shut down.

The various tools and utilities that make up the full Unix system experience reside on the computer's disk and are only brought into memory and executed as requested. Virtually every Unix command you know is a utility; therefore, the program resides on the disk and is only brought into memory at your request. So, for example, when you execute the `date` command, the Unix system loads the program called `date` from the computer's disk into memory and begins reading its code to take the specified action or actions.

The shell is also a utility program and is loaded into memory for execution as part of your login sequence. In fact, it's worth learning the precise sequence of events that occurs when the first shell on a terminal or window starts up.

The Login Shell

In the old days, terminals were physical devices that were connected to the Unix hardware through a direct wire. Nowadays, however, terminal programs let you stay within your Linux, Mac or Windows environment and interact with the system over the network in a managed window. Generally you launch a program such as Terminal or xterm, then connect to remote systems as needed using programs such as `ssh`, `telnet`, or `rlogin`.

For each physical terminal on a system, a program called `getty` will be active. This is depicted in Figure 2.2.

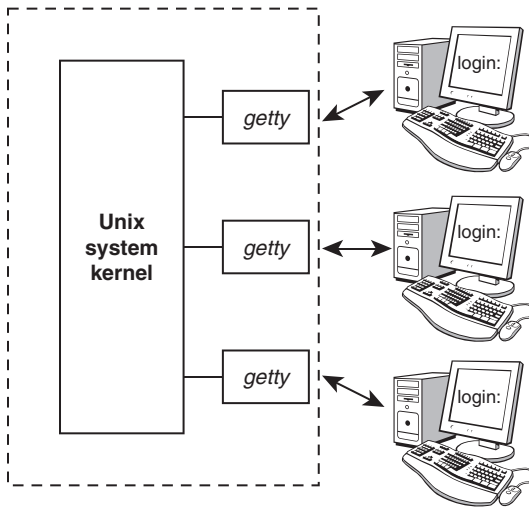

Figure 2.2 The `getty` process

The Unix system—more precisely a program called `init`—automatically starts up a `getty` program on each terminal port whenever the system is allowing users to log in. `getty` is essentially a device driver, letting the `login` program display the message `login:` at its assigned terminal and wait for someone to type in something.

If you connect via a program like `ssh`, you'll be assigned a pseudo-terminal or pseudo-tty, in Unix parlance. That's why when you typed in `who` you saw entries like `pty3` or `pty1`.

In both instances, there is the program that reads your account and password information, and the program that validates it and invokes whatever login programs are needed for you to “log in” if everything checks out and is correct.

As soon as someone types in some characters followed by the `Enter` key, the `login` program finishes the process of logging in (see Figure 2.3).

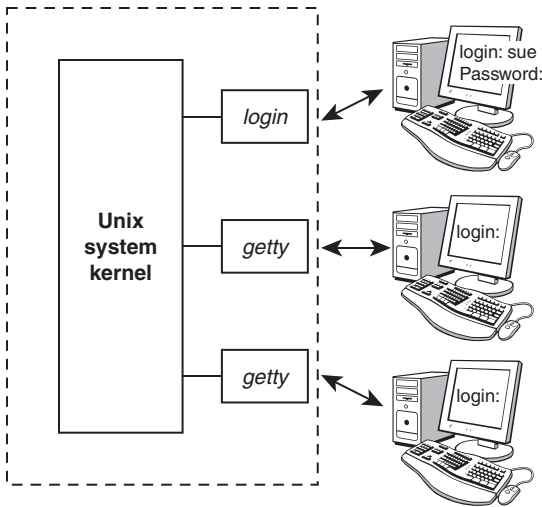

Figure 2.3 `login` started on `sue`'s terminal

When `login` begins execution, it displays the string `Password:` at the terminal and then waits for you to type your password. After you have typed it and pressed `Enter` (you won't see any output as you type, for security reasons), `login` then proceeds to verify your login name and password against the corresponding entry in the file `/etc/passwd`. This file contains an entry for each user account that specifies, among other things, the login name, home directory, and program to start up when that user logs in. The last bit of information (the login shell) is stored after the *last* colon of each line. If nothing follows the last colon, the *standard* shell `/bin/sh` is assumed by default.

If you log in through a terminal program, the data handshake might involve a program like `ssh` on your system and `sshd` on the server, and if you're opening up a window on your Unix computer, it will likely just instantly log you in without you having to again type in your password. Handy!

But back to the password file. The following three lines show typical lines from `/etc/passwd` for three users of the system: `sue`, `pat`, and `bob`:

```
sue:*:15:47:::/users/sue:
pat:*:99:7:::/users/pat:/bin/ksh
bob:*:13:100:::/users/data:/users/data/bin/data_entry
```

After `login` validates an encrypted version of the password you typed in against the encrypted password for the specified account as stored in `/etc/shadow`, it then checks for the name of the login program to execute. In most cases, this will be `/bin/sh`, `/bin/ksh`, or `/bin/bash`. In other cases, it may be a special custom-designed program or `/bin/nologin` for accounts that don't include interactive access (common for file ownership management). The idea underlying them all is that you can set up a login account to automatically run any program whatsoever whenever someone logs in to the system. The shell is the program most often selected because of its general utility, but it's not the only game in town.

Back to Sue. Once she's validated, `login` essentially kills itself, handing off control of Sue's terminal connection to the standard shell and then vanishing from memory (see Figure 2.4).

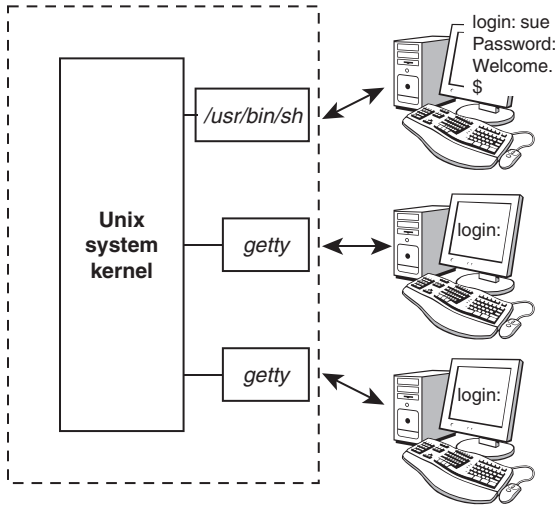

Figure 2.4 `login` executes `/usr/bin/sh`

According to the other entries from `/etc/passwd` shown previously, `pat` gets the program `ksh` stored in `/bin` (this is the Korn shell), and `bob` gets the specialized program `data_entry` (see Figure 2.5).

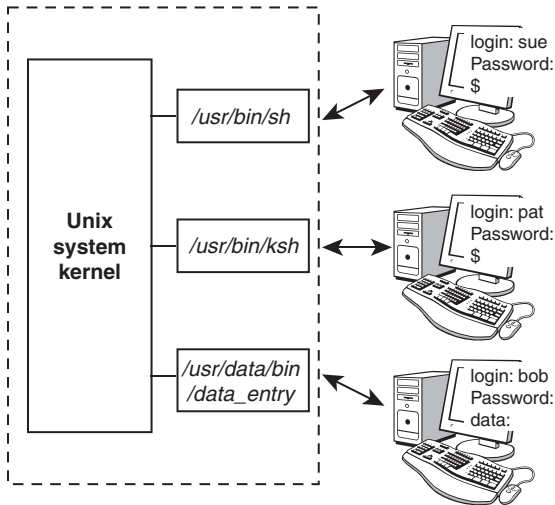

Figure 2.5 Three users logged in

As mentioned earlier, the `init` program runs programs similar to `getty` for networked connections. For example, `sshd`, `telnetd`, and `rlogind` answer connection requests via `ssh`, `telnet`, and `rlogin`, respectively. Instead of being tied directly to a specific, physical terminal or modem line, these programs connect users' shells to *pseudo-ttys*. You can see this whether you're logged in to your system over a network, on an X Windows screen, or through a networked terminal connection program with the `who` command:

```
$ who
phw      pts/0    Jul 20 17:37      Logged in with rlogin
$
```

Typing Commands to the Shell

When the shell starts up, it displays a command prompt—typically a dollar sign `$`—at your terminal and then waits for you to type in a command (Figure 2.6, Steps 1 and 2). Each time you type in a command and press the `Enter` key (Step 3), the shell analyzes what you typed and proceeds to carry out your request (Step 4).

If you ask the shell to invoke a particular program, it searches the disk, stepping through all the directories you've specified in your `PATH` until it finds the named program. When the program is found, the shell creates a clone of itself (known as a *subshell*) and asks the kernel to replace the subshell with the specified program; then the login shell “goes to sleep” until the program has finished (Step 5). The kernel copies the specified program into memory and begins its execution. This copied program is called a *process*; in this way, the distinction is made between a program that is kept in a file on the disk and a process that is in memory and being executed, line by line.

If the program writes output to standard output, that output will appear at your terminal unless redirected or piped into another command. Similarly, if the program reads input from standard input, it will wait for you to type in that input unless redirected from a file or piped from another command (Step 6).

When the command finishes execution, it vanishes and control once again returns to the login shell, which prompts for your next command (Steps 7 and 8).

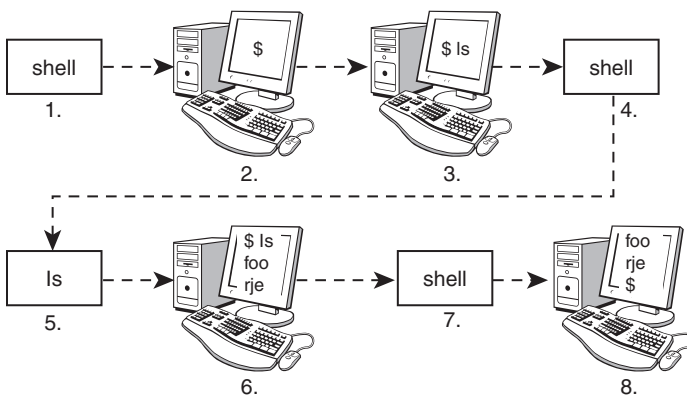

Figure 2.6 Command cycle

Note that this cycle continues as long as you're logged in. When you log off the system, execution of the shell then terminates and the system starts up a new `getty` (or `rlogind`, and so on) and waits for someone else to log in. This cycle is illustrated in Figure 2.7.

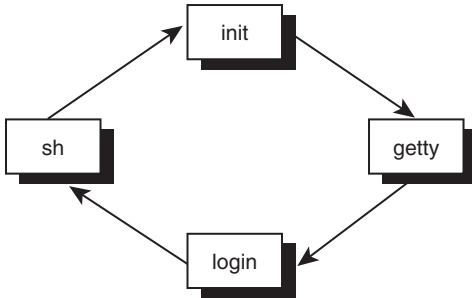

Figure 2.7 Login cycle

It's important to recognize that the shell is just a program. It has no special privileges on the system, meaning that anyone with sufficient expertise and enthusiasm can create their own shell. That's why so many different variations or "flavors" of the shell exist today, including the older Bourne shell, developed by Stephen Bourne; the Korn shell, developed by David Korn; the "Bourne again shell," mainly used on Linux systems; and the C shell, developed by Bill Joy. They were all designed to serve specific purposes and have their own unique capabilities and personalities.

The Shell's Responsibilities

Now you know that the shell analyzes (to use proper computer parlance, it *parses*) each line you type in and initiates execution of the selected program. It's during the parsing phase that filename expansion special characters like `*` are expanded, as discussed in the previous chapter.

The shell also has other responsibilities, as outlined in Figure 2.8.

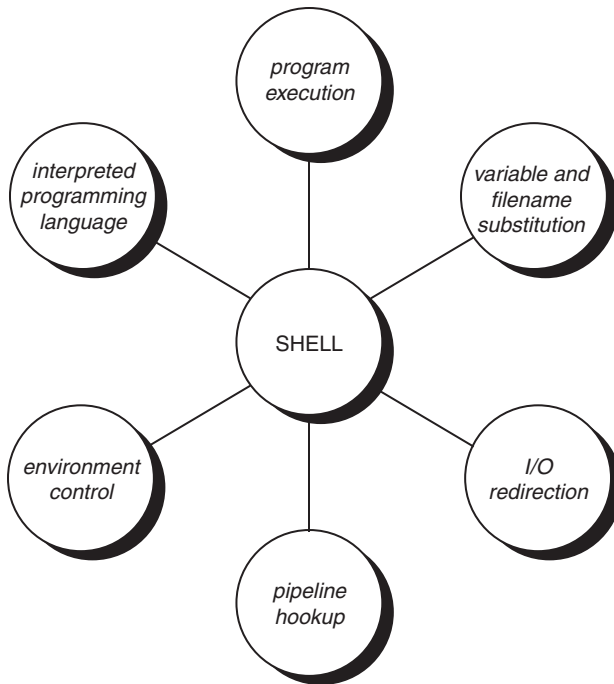

Figure 2.8 The shell's responsibilities

Program Execution

The shell is responsible for the execution of all programs that you request from your terminal.

Each time you type in a line to the shell, the shell analyzes the line and then determines what to do. As far as the shell is concerned, each line follows the same basic format:

```
program-name arguments
```

The line that is typed to the shell is known more formally as the *command line*. The shell scans this command line and determines the name of the program to be executed and what arguments to pass to the program.

The shell uses special characters to determine where the program name starts and ends, and where each argument starts and ends. These characters are collectively called *whitespace characters*, and are the space character, the horizontal tab character, and the end-of-line character, known more formally as the *newline character*. Multiple occurrences of whitespace characters are ignored by the shell. When you type the command

```
mv tmp/mazewars games
```

the shell scans the command line and takes everything from the start of the line to the first whitespace character as the name of the program to execute: `mv`. Subsequent whitespace (the extra spaces) are ignored and the set of characters up to the next whitespace character is the first argument to `mv`: `tmp/mazewars`. The characters up to the next whitespace character—in this case, the newline character—is the second argument to `mv`: `games`. After parsing the command line, the shell then proceeds to execute the `mv` command, giving it the two specified arguments `tmp/mazewars` and `games` (see Figure 2.9).

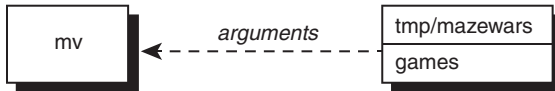

Figure 2.9 Execution of `mv` with two arguments

As mentioned, multiple occurrences of whitespace characters are ignored by the shell. This means that when the shell processes this command line:

```
echo          when   do           we     eat?
```

it passes four arguments to the `echo` program: `when`, `do`, `we`, and `eat?` (see Figure 2.10).

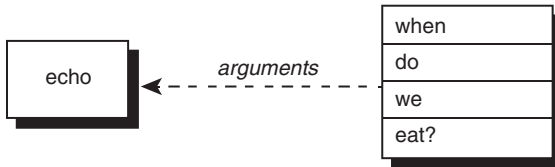

Figure 2.10 Execution of `echo` with four arguments

Because `echo` takes its arguments and simply displays them at the terminal, adding an individual space between each argument, the output from the following becomes a lot more legible:

```
$ echo          when   do           we     eat?
when do we eat?
$
```

It turns out the `echo` command never sees those blank spaces; they have been “gobbled up” by the shell. When we discuss quotes in Chapter 5, you’ll see how you can include blank spaces in arguments to programs, but usually having extras vanish is exactly the behavior you want.

We mentioned earlier that the shell searches the disk until it finds the program you want to execute and then asks the Unix kernel to initiate its execution. This is true most of the time. However, there are some commands that are actually built into the shell itself. These built-in commands include `cd`, `pwd`, and `echo`. Before the shell searches the disk for a command, it first determines whether it’s a built-in command, and if so executes the command directly.

But there's a bit more the shell does before individual programs are invoked, so let's talk about those for just a moment too.

Variable and Filename Substitution

Like a more formal programming language, the shell lets you assign values to variables. Whenever you specify one of these variables on the command line preceded by a dollar sign, the shell substitutes the value assigned to the variable. This topic is covered in much more detail in Chapter 4.

The shell also performs filename substitution on the command line. In fact, the shell scans the command line looking for filename substitution characters `*`, `?`, or `[...]` before determining the name of the program to execute and its arguments.

Suppose that your current directory contains these files:

```
$ ls
mrs.todd
prog1
shortcut
sweeney
$
```

Now let's use filename substitution (`*`) for the `echo` command:

```
$ echo *           List all files
mrs.todd prog1 shortcut sweeney
$
```

How many arguments were passed to the `echo` program, one or four? Because the shell performs the filename substitution, the answer is four. When the shell analyzes the line

```
echo *
```

it recognizes the special character `*` and substitutes the names of all files in the current directory (it even alphabetizes them for you):

```
echo mrs.todd prog1 shortcut sweeney
```

Then the shell determines what arguments to pass to the actual command. So `echo` never sees the asterisk and as far as it's concerned, four arguments were typed on the command line (see Figure 2.11).

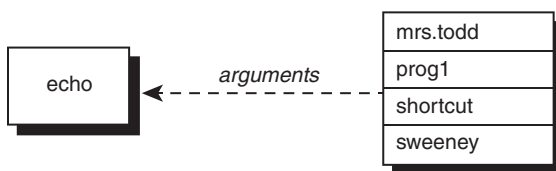

Figure 2.11 Execution of `echo`

I/O Redirection

It is also the shell's responsibility to take care of input and output redirection. It scans each entered command line for occurrences of the special redirection characters `<`, `>`, or `>>` (in case you're curious, there is a `<<` redirection sequence, as you'll learn in Chapter 12).

When you type the command

```
echo Remember to record The Walking Dead > reminder
```

the shell recognizes the special output redirection character `>` and takes the next word on the command line as the name of the file to which the output should be redirected. In this case, the file is called `reminder`. If `reminder` already exists and you have write access, the previous contents are overwritten. If you don't have write access to the file or its directory, the shell will produce an error message.

Before the shell starts execution of the desired program, it redirects the standard output of the program to the indicated file. In almost every case, the program never knows that its output is being redirected. It just goes on its merry way writing to standard output (which is normally your terminal, you'll recall), unaware that the shell has redirected that information to a file.

Let's take another look at two nearly identical commands:

```
$ wc -l users
    5 users
$ wc -l < users
    5
$
```

In the first case, the shell parses the command line and determines that the name of the program to execute is `wc` and passes it two arguments: `-l` and `users` (see Figure 2.12).

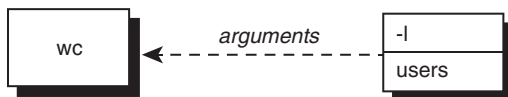

Figure 2.12 Execution of `wc -l users`

When `wc` begins execution, it sees that it was passed the two arguments. The first, `-l`, tells it to count the number of lines. The second argument specifies the name of the file whose lines are to be counted. So `wc` opens the file `users`, counts its lines, and then prints the resultant count along with the filename.

Operation of `wc` in the second case is slightly different. The shell spots the input redirection character `<` when it scans the command line. The word that follows on the command line is therefore interpreted as the name of the file from which input is to be redirected. Having “gobbled up” the `< users` from the command line, the shell then starts execution of the `wc` program, redirecting its standard input from the file `users` and passing it only the single argument `-l` (see Figure 2.13).

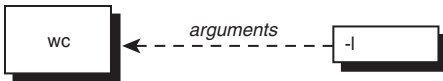

Figure 2.13 Execution of `wc -l < users`

When `wc` begins execution this time, it sees that it was passed the single argument `-l`. Because no filename was specified, `wc` decides that the number of lines coming in from standard input should be counted instead. So `wc -l` counts the number of lines, unaware that it's actually counting the number of lines in the file `users`. The final tally is displayed as usual, but without the name of a file because `wc` wasn't given one.

The difference in execution of the two commands is important for you to understand. If you're still unclear on this point, review the preceding section one more time before proceeding.

Hooking up a Pipeline

Just as the shell scans the command line looking for redirection characters, it also looks for the pipe character `|`. For each match, it connects the standard output from the preceding command to the standard input of the subsequent one, then initiates execution of both programs.

So when you type

```
who | wc -l
```

the shell finds the pipe symbol separating the commands `who` and `wc`. It connects the standard output of the former command to the standard input of the latter, then initiates execution of both. When the `who` command executes, it produces a list of who's logged in and writes the results to standard output, unaware that this is not going to the terminal but to another command instead.

When the `wc` command executes, it recognizes that no filename was specified and counts the lines on standard input, unaware that standard input is not coming from the terminal but from the output of the `who` command.

As we proceed, you'll see that not only can you have two-command pipelines; you can string together three, four, five, or more commands in really complicated pipelines too. It's a bit tricky to figure out, but that's really where some of the greatest power of the Unix system hides.

Environment Control

The shell provides certain commands that let you customize your environment. Your environment includes your home directory, the characters that the shell displays to prompt you to type in a command, and a list of the directories to be searched whenever you request that a program be executed. You'll learn more about this in Chapter 10.

Interpreted Programming Language

The shell has its own built-in programming language. This language is *interpreted*, meaning that the shell analyzes each statement as encountered, then executes any valid commands found. This differs from programming languages like C++ and Swift, in which the programming statements are typically compiled into a machine-executable form before they are executed.

Programs developed in interpreted programming languages are typically easier to debug and modify than compiled ones. However, they can take longer to execute than their compiled equivalents.

The shell programming language provides features you'd find in most other programming languages. It has looping constructs, decision-making statements, variables, and functions, and is procedure-oriented. Modern shells based on the IEEE POSIX standard have many other features including arrays, data typing, and built-in arithmetic operations.

Tools of the Trade

This chapter provides detailed descriptions of some commonly used shell programming tools. Covered are `cut`, `paste`, `sed`, `tr`, `grep`, `uniq`, and `sort`. The more proficient you become at using these tools, the easier it will be to write efficient shell scripts.

Regular Expressions

Before getting into the tools, you need to learn about *regular expressions*. Regular expressions are used by many different Unix commands, including `ed`, `sed`, `awk`, `grep`, and, to a more limited extent, the `vi` editor. They provide a convenient and consistent way of specifying *patterns* to be matched.

Where this gets confusing is that the shell recognizes a limited form of regular expressions with filename substitution. Recall that the asterisk (*) specifies zero or more characters to match, the question mark (?) specifies any single character, and the construct [...] specifies any character enclosed between the brackets. But that's not the same thing as the more formal regular expressions we'll explore. For example, the shell sees ? as a match for any single character, while a regular expression—commonly abbreviated *regex*—uses a period (.) for the same purpose.

True regular expressions are far more sophisticated than those recognized by the shell and there are entire books written about how to assemble really complex regex statements. Don't worry, though, you won't need to become an expert to find great value in regular expressions!

Throughout this section, we assume familiarity with a line-based editor such as `ex` or `ed`. See Appendix B for more information on these editors if you're not familiar with them, or check the appropriate `man` page.

Matching Any Character: The Period (.)

A period in a regular expression matches any single character, no matter what it is. So the regular expression

```
r.
```

matches an `r` followed by any single character.

The regular expression

`.x.`

matches an `x` that is surrounded by any two characters, not necessarily the same.

We can demonstrate a lot of regular expressions by using the simple `ed` editor, an old-school line-oriented editor that has been around as long as Linux have been around.

For example, the `ed` command

```
/ ... /
```

searches forward in the file you are editing for the first line that contains any three characters surrounded by blanks. But before we demonstrate that, notice in the very beginning of this example that `ed` shows the number of characters in the file (248) and that commands like `print` (`p`) can be prefixed with a range specifier, with the most basic being `1, $`, which is the first through last line of the file:

```
$ ed intro
248
1,$p                               Print all the lines
The Unix operating system was pioneered by Ken
Thompson and Dennis Ritchie at Bell Laboratories
in the late 1960s. One of the primary goals in
the design of the Unix system was to create an
environment that promoted efficient program
development.
```

That's our working file. Now let's try some regular expressions:

```
/ ... /                               Look for three chars surrounded by blanks
The Unix operating system was pioneered by Ken
/                                       Repeat last search
Thompson and Dennis Ritchie at Bell Laboratories
1,$s/p.o/XXX/g                         Change all p.os to XXX
1,$p                                     Let's see what happened
The Unix operating system was XXXneered by Ken
ThomXXXn and Dennis Ritchie at Bell Laboratories
in the late 1960s. One of the primary goals in
the design of the Unix system was to create an
environment that XXXmoted efficient XXXgram
development.
```

In the first search, `ed` started searching from the beginning of the file and found that the sequence “`was`” in the first line matched the indicated pattern and printed it.

Repeating the search (the `ed` command `/`) resulted in the display of the second line of the file because “`and`” matched the pattern. The substitute command `s` that followed specified that all occurrences of the character `p`, followed by any single character, followed by the character `o` were to be replaced by the characters `xxx`. The prefix `1, $` indicates that it should be applied to all lines in the file, and the substitution is specified with the structure `s/old/new/g`, where `s`

indicates it's a substitution, the slashes delimit the old and new values, and `g` indicates it should be applied as many times as needed for each line, not just once per line.

Matching the Beginning of the Line: The Caret (^)

When the caret character `^` is used as the first character in a regular expression, it matches the beginning of the line. So the regular expression

```
^George
```

matches the characters `George` *only if they occur at the beginning of the line*. This is actually known as “left-rooting” in the regex world, for obvious reasons.

Let's have a look:

```
$ ed intro
248
/the/
>>in the late 1960s. One of the primary goals in
>>the design of the Unix system was to create an
/^the/           Find the line that starts with the
the design of the Unix system was to create an
1,$s/^/>>/       Insert >> at the beginning of each line
1,$p
>>The Unix operating system was pioneered by Ken
>>Thompson and Dennis Ritchie at Bell Laboratories
>>in the late 1960s. One of the primary goals in
>>the design of the Unix system was to create an
>>environment that promoted efficient program
>>development.
```

The preceding example also shows how the regular expression `^` can be used to match the beginning of the line. Here it is used to insert the characters `>>` at the start of each line.

A command like

```
1,$s/^/    /
```

is also commonly used to insert spaces at the start of each line (in this case four spaces would be inserted).

Matching the End of the Line: The Dollar Sign \$

Just as the `^` is used to match the beginning of the line, so the dollar sign `$` is used to match the end of the line. So the regular expression

```
contents$
```

matches the characters `contents` *only if they are the last characters on the line*. What do you think would be matched by the regular expression

```
.$
```

Would this match a period character that ends a line? No. Recall that the period matches any character, so this would match any single character at the end of the line (including a period).

So how do you match a period? In general, if you want to match any of the characters that have a special meaning in regular expressions, precede the character by a backslash (\) to override its special meaning. For example, the regular expression

```
\.$
```

matches any line that ends in a period, and the regular expression

```
^\.
```

matches any line that starts with a period.

Want to specify a backslash as an actual character? Use two backslashes in a row: \\.

```
$ ed intro
248
/\.$/                               Search for a line that ends with a period
development.
1,$s/$/>>/                             Add >> to the end of each line
1,$p
The Unix operating system was pioneered by Ken>>
Thompson and Dennis Ritchie at Bell Laboratories>>
in the late 1960s. One of the primary goals in>>
the design of the Unix system was to create an>>
environment that promoted efficient program>>
development.>>
1,$s/..$//                             Delete the last two characters from each line
1,$p
The Unix operating system was pioneered by Ken
Thompson and Dennis Ritchie at Bell Laboratories
in the late 1960s. One of the primary goals in
the design of the Unix system was to create an
environment that promoted efficient program
development.
```

A common use of ^ and \$ is the regular expression

```
^$
```

which matches any line that contains *no* characters at all. Note that this regular expression is different from

```
^ $
```

which matches any line that consists of a single space character.

Matching a Character Set: The [. . .] Construct

Suppose that you are editing a file and want to search for the first occurrence of the characters `the`. In `ed`, this is easy: You simply type the command

```
/the/
```

This causes `ed` to search forward in its buffer until it finds a line containing the indicated sequence. The first line that matches will be displayed by `ed`:

```
$ ed intro
248
/the/                               Find line containing the
in the late 1960s. One of the primary goals in
```

Notice that the first line of the file also contains the word `the`, except it begins with a capital `T`. A regular expression that searches for either `the` or `The` can be built using a character set: the characters `[` and `]` can be used to specify that one of the enclosed character set is to be matched. The regular expression

```
[tT]he
```

would match a lower- or uppercase `t` followed immediately by the characters `he`:

```
$ ed intro
248
/[tT]he/                             Look for the or The
The Unix operating system was pioneered by Ken
/                                       Continue the search
in the late 1960s. One of the primary goals in
/                                       Once again
the design of the Unix system was to create an
1,$s/[aeiouAEIOU]/g                 Delete all vowels
1,$p
Th nx prtng systm ws pnrld by Kn
Thmpsn nd Dnns Rtch t Bll Lbrtrs
n th lt 1960s. n f th prmry gls n
th dsgn f th nx systm ws t crt n
nvrnmnt tht prmtd ffcnt prgrm
dvlpmnt.
```

Notice the example in the above of `[aeiouAEIOU]` which will match a single vowel, either uppercase or lowercase. That notation can get rather clunky, however, so a range of characters can be specified inside the brackets instead. This can be done by separating the starting and ending characters of the range by a dash (`-`). So, to match any digit character `0` through `9`, you could use the regular expression

```
[0123456789]
```

or, more succinctly, you could write

```
[0-9]
```

To match an uppercase letter, use

```
[A-Z]
```

To match an upper- or lowercase letter, you write

```
[A-Za-z]
```

Here are some examples with `ed`:

```
$ ed intro
248
/[0-9]/                Find a line containing a digit
in the late 1960s. One of the primary goals in
/^ [A-Z]/              Find a line that starts with an uppercase letter
The Unix operating system was pioneered by Ken
/                      Again
Thompson and Dennis Ritchie at Bell Laboratories
1, $s/[A-Z]/* /g      Change all uppercase letters to *s
1, $p
*he *nix operating system was pioneered by *en
*thompson and *ennis *itchie at *ell *aboratories
in the late 1960s. *ne of the primary goals in
the design of the *nix system was to create an
environment that promoted efficient program
development.
```

As you'll learn below, the asterisk is a special character in regular expressions. However, you don't need to put a backslash before it in the replacement string of the substitute command because the substitution's replacement string has a different expression language (we did mention that this can be a bit tricky at times, right?).

In the `ed` editor, regular expression sequences such as `*`, `.`, `[...]`, `$`, and `^` are only meaningful in the search string and have no special meaning when they appear in the replacement string.

If a caret (`^`) appears as the first character after the left bracket, the sense of the match is *inverted*. (By comparison, the shell uses the `!` for this purpose with character sets.) For example, the regular expression

```
[^A-Z]
```

matches any character *except* an uppercase letter. Similarly,

```
[^A-Za-z]
```

matches any non-alphabetic character. To demonstrate, let's remove all non-alphabetic characters from the lines in our test file:

```
$ ed intro
248
1, $s/[^a-zA-Z]//g      Delete all non-alphabetic characters
1, $p
TheUnixoperatingsystemwaspioneeredbyKen
ThompsonandDennisRitchieatBellLaboratories
```

In the late 1960s, one of the primary goals in the design of the Unix system was to create an environment that promoted efficient program development.

Matching Zero or More Characters: The Asterisk (*)

The asterisk is used by the shell in filename substitution to match zero or more characters. In forming regular expressions, the asterisk is used to match zero or more occurrences of the *preceding* element of the regular expression (which may itself be another regular expression).

So, for example, the regular expression

x*

matches zero, one, two, three, ... capital x's while the expression

xx*

matches one or more capital x's, because the expression specifies a single x followed by zero or more x's. You can accomplish the same effect with a + instead: it matches *one or more* of the preceding expression, so **xx*** and **x+** are identical in function.

A similar type of pattern is frequently used to match one or more blank spaces in a line:

```
$ ed lotsaspaces
85
1, $p
This      is  an example  of a
file that contains      a lot
of blank spaces           Change multiple blanks to single blanks
1, $s/ */ /g
1, $p
This is an example of a
file that contains a lot
of blank spaces
```

The **ed** command

```
1, $s/ */ /g
```

told the program to substitute all occurrences of a space followed by zero or more spaces with a single space—in other words, to collapse all whitespace into single spaces. If it matches a single space, there's no change. But if it matches three spaces, say, they'll all be replaced by a single space.

The regular expression

.*

is often used to specify zero or more occurrences of *any* characters. Bear in mind that a regular expression matches the *longest* string of characters that match the pattern. Therefore, used by itself, this regular expression always matches the *entire* line of text.

As another example of the combination of `.` and `*`, the regular expression

```
e.*e
```

matches all the characters from the first `e` on a line to the last one.

Note that it doesn't necessarily match only lines that start and end with an `e`, however, because it's not left- or right-rooted (that is, it doesn't use `^` or `$` in the pattern).

```
$ ed intro
248
1,$s/e.*e/+/+/
1,$p
Th+++n
Thompson and D+++S
in th+++ primary goals in
th+++ an
++++nt program
d++++nt.
```

Here's an interesting regular expression. What do you think it matches?

```
[A-Za-z] [A-Za-z]*
```

This matches any alphabetic character followed by zero or more alphabetic characters. This is pretty close to a regular expression that matches words and can be used as shown below to replace all words with the letter `x` while retaining all spaces and punctuation.

```
$ ed intro
248
1,$s/[A-Za-z] [A-Za-z]*/X/g
1,$p
X X X X X X X X
X X X X X X X
X X X 1960X. X X X X X X
X X X X X X X X X
X X X X X
X.
```

The only thing it didn't match in this example was the numeric sequence `1960`. You can change the regular expression to also consider a sequence of digits as a word too, of course:

```
$ ed intro
248
1,$s/[A-Za-z0-9] [A-Za-z0-9]*/X/g
1,$p
X X X X X X X X
X X X X X X X
X X X X. X X X X X X
X X X X X X X X X X
X X X X X
X.
```

We could expand on this to consider hyphenated and contracted words (for example, *don't*), but we'll leave that as an exercise for you. As a point to note, if you want to match a dash character inside a bracketed choice of characters, you must put the dash immediately after the left bracket (but after the inversion character `^` if present) or immediately before the right bracket for it to be properly understood. That is, either of these expressions

```
[-0-9]
[0-9-]
```

matches a single dash or digit character.

In a similar fashion, if you want to match a right bracket character, it must appear after the opening left bracket (and after the `^` if present). So

```
[]a-z]
```

matches a right bracket or a lowercase letter.

Matching a Precise Number of Subpatterns: `\{ . . . \}`

In the preceding examples, you saw how to use the asterisk to specify that *one* or more occurrences of the preceding regular expression are to be matched. For instance, the regular expression

```
xx*
```

means match an `x` followed by zero or more subsequent occurrences of the letter `x`. Similarly,

```
xxx*
```

means match at least *two* consecutive `x`'s.

Once you get to this point, however, it ends up rather clunky, so there is a more general way to specify a precise number of characters to be matched: by using the construct

```
\{min,max\}
```

where *min* specifies the minimum number of occurrences of the preceding regular expression to be matched, and *max* specifies the maximum. Notice that you need to *escape* the curly brackets by preceding each with a backslash.

The regular expression

```
x\{1,10\}
```

matches from one to 10 consecutive `x`'s. Whenever there's a choice, the largest pattern is matched, so if the input text contains eight consecutive `x`'s, that is how many will be matched by the preceding regular expression.

As another example, the regular expression

```
[A-Za-z]\{4,7\}
```

matches a sequence of alphabetic letters from four to seven characters long.

Let's try a substitution using this notation:

```
$ ed intro
248
1,$s/[A-Za-z]\{4,7\}/X/g
1,$p
The X Xng X was Xed by Ken
Xn and X X at X XX
in the X 1960s. One of the X X in
the X of the X X was to X an
XX X Xd Xnt X
XX.
```

This invocation is a specific instance of a global search and replace in `ed` (and, therefore, also in `vi`): `s/old/new/`. In this case, we add a range of `1, $` beforehand and the `g` flag is appended to ensure that multiple substitutions will occur on each line, as appropriate.

A few special cases of this special construct are worth noting. If only one number is enclosed by braces, as in

```
\{10\}
```

that number specifies that the preceding regular expression must be matched *exactly* that many times. So

```
[a-zA-Z]\{7\}
```

matches exactly seven alphabetic characters; and

```
.\{10\}
```

matches exactly 10 characters no matter what they are:

```
$ ed intro
248
1,$s/^\{10\}//           Delete the first 10 chars from each line
1,$p
perating system was pioneered by Ken
nd Dennis Ritchie at Bell Laboratories
e 1960s. One of the primary goals in
  of the Unix system was to create an
t that promoted efficient program
t.
1,$s/.\{5\}$//         Delete the last 5 chars from each line
1,$p
perating system was pioneered b
nd Dennis Ritchie at Bell Laborat
e 1960s. One of the primary goa
  of the Unix system was to crea
t that promoted efficient pr
t.
```

Note that the last line of the file didn't have five characters when the last substitute command was executed; therefore, the match failed on that line and thus was left alone because we specified that *exactly* five characters were to be deleted.

If a single number is enclosed in the braces, followed immediately by a comma, then at *least* that many occurrences of the previous regular expression must be matched, but no upper limit is set. So

```
+{5,}
```

matches at least five consecutive plus signs. If more than five occur sequentially in the input data, the largest number is matched.

```
$ ed intro
248
1,$s/[a-zA-Z]{6,}/X/g          Change words at least 6 letters long to X
1,$p
The Unix X X was X by Ken
X and X X at Bell X
in the late 1960s. One of the X goals in
the X of the Unix X was to X an
X that X X X
X.
```

Saving Matched Characters: \ (. . . \)

It is possible to reference the characters matched against a regular expression by enclosing those characters inside backslashed parentheses. These captured characters are stored in pre-defined variables in the regular expression parser called *registers*, which are numbered 1 through 9.

This gets a bit confusing, so take this section slowly!

As a first example, the regular expression

```
^(.)
```

matches the first character on the line, whatever it is, and stores it into register 1.

To retrieve the characters stored in a particular register, the construct `\n` is used, where `n` is a digit from 1 to 9. So the regular expression

```
^(.)\1
```

initially matches the first character on the line and stores it in register 1, then matches whatever is stored in register 1, as specified by the `\1`. The net effect of this regular expression is to match the first two characters on a line *if they are both the same character*. Tricky, eh?

The regular expression

```
^(.)*\1$
```

matches all lines in which the first character on the line (`^.`) is the same as the last character on the line (`\1$`). The `.*` matches all the characters in-between.

Let's break this one down. Remember `^` is the beginning of line and `$` the end of line. The simplified pattern is then `. .*` which is the first character of the line (the first `.`) followed by the `.*` for the rest of the line. Add the `\(\)` notation to push that first character into register 1 and `\1` to then reference the character, and it should make sense to you.

Successive occurrences of the `\(...\)` construct get assigned to successive registers. So when the following regular expression is used to match some text

```
^\(...\) \(...\)
```

the first three characters on the line will be stored into register 1, and the next three characters into register 2. If you appended `\2\1` to the pattern, you would match a 12-character string in which characters 1–3 matched characters 10–12, and in which characters 4–6 matched characters 7–9.

When using the substitute command in `ed`, a register can also be referenced as part of the replacement string, which is where this can be really powerful:

```
$ ed phonebook
114
1, $p
Alice Chebba      973-555-2015
Barbara Swingle  201-555-9257
Liz Stachiw      212-555-2298
Susan Goldberg   201-555-7776
Tony Iannino     973-555-1295
1, $s/\(.*\) \2 \1/           Switch the two fields
1, $p
973-555-2015 Alice Chebba
201-555-9257 Barbara Swingle
212-555-2298 Liz Stachiw
201-555-7776 Susan Goldberg
973-555-1295 Tony Iannino
```

The names and the phone numbers are separated from each other in the `phonebook` file by a single tab character. The regular expression

```
\(.*\) \2 \1
```

says to match all the characters up to the first tab (that's the character sequence `.*` between the `\(` and the `\)`) and assign them to register 1, and to match all the characters that follow the tab character and assign them to register 2. The replacement string

```
\2 \1
```

specifies the contents of register 2, followed by a space, followed by the contents of register 1.

When `ed` applies the substitute command to the first line of the file:

```
Alice Chebba      973-555-2015
```

it matches everything up to the tab (`Alice Chebba`) and stores it into register 1, and everything after the tab (`973-555-2015`) and stores it into register 2. The tab itself is lost because it's not surrounded by parentheses in the regex. Then `ed` substitutes the characters that were matched (the entire line) with the contents of register 2 (`973-555-2015`), followed by a space, followed by the contents of register 1 (`Alice Chebba`):

```
973-555-2015 Alice Chebba
```

As you can see, regular expressions are powerful tools that enable you to match and manipulate complex patterns, albeit with a slight tendency to look like a cat ran over your keyboard at times!

Table 3.1 summarizes the special characters recognized in regular expressions to help you understand all you encounter and so you can build your own as needed.

Table 3.1 Regular Expression Characters

Notation	Meaning	Example	Matches
<code>.</code>	Any character	<code>a..</code>	<code>a</code> followed by any two characters
<code>^</code>	Beginning of line	<code>^wood</code>	<code>wood</code> only if it appears at the beginning of the line
<code>\$</code>	End of line	<code>x\$</code>	<code>x</code> only if it is the last character on the line
		<code>^INSERT\$</code>	A line containing just the characters <code>INSERT</code>
		<code>^\$</code>	A line that contains <i>no</i> characters
<code>*</code>	Zero or more occurrences of previous regular expression	<code>x*</code> <code>xx*</code> <code>.*</code> <code>w.*s</code>	Zero or more consecutive <code>x</code> 's One or more consecutive <code>x</code> 's Zero or more characters <code>w</code> followed by zero or more characters followed by an <code>s</code>
<code>+</code>	One or more occurrences of previous regular expression	<code>x+</code> <code>xx+</code> <code>.*+</code> <code>w.+s</code>	One or more consecutive <code>x</code> 's Two or more consecutive <code>x</code> 's One or more characters <code>w</code> followed by one or more characters followed by an <code>s</code>
<code>[chars]</code>	Any character in <i>chars</i>	<code>[tT]</code> <code>[a-z]</code> <code>[a-zA-Z]</code>	Lower- or uppercase <code>t</code> Lowercase letter Lower- or uppercase letter
<code>[^chars]</code>	Any character <i>not</i> in <i>chars</i>	<code>[^0-9]</code> <code>[^a-zA-Z]</code>	Any non-numeric character Any non-alphabetic character

(Continued)

Notation	Meaning	Example	Matches
<code>\{min,max\}</code>	At least <i>min</i> and at most <i>max</i> occurrences of previous regular expression	<code>x\{1,5\}</code> <code>[0-9]\{3,9\}</code> <code>[0-9]\{3\}</code> <code>[0-9]\{3,\}</code>	At least 1 and at most 5 x's Anywhere from 3 to 9 successive digits Exactly 3 digits At least 3 digits
<code>\(...\)</code>	Save characters matched between parentheses in next register (1-9)	<code>^\(...)</code> <code>^\(...)\1</code> <code>^\(...)\(...)</code>	First character on the line; stores it in register 1 First and second characters on the line if they're the same First and second characters on the line; stores first character in register 1 and second character in register 2

cut

This section teaches you about a useful command known as `cut`. This command comes in handy when you need to extract (that is, “cut out”) various fields of data from a data file or the output of a command. The general format of the `cut` command is

```
cut -cchars file
```

where *chars* specifies which characters (by position) you want to extract from each line of *file*. This can consist of a single number, as in `-c5` to extract the fifth character from each line of input; a comma-separated list of numbers, as in `-c1,13,50` to extract characters 1, 13, and 50; or a dash-separated range of numbers, as in `-c20-50` to extract characters 20 through 50, inclusive. To extract characters to the end of the line, you can omit the second number of the range so

```
cut -c5- data
```

extracts characters 5 through the end of the line from each line of `data` and writes the results to standard output.

If *file* is not specified, `cut` reads its input from standard input, meaning that you can use `cut` as a filter in a pipeline.

Let’s take another look at the output from the `who` command:

```
$ who
root    console Feb 24 08:54
steve   tty02    Feb 24 12:55
george  tty08    Feb 24 09:15
dawn    tty10    Feb 24 15:55
$
```

As shown, four people are logged in. Suppose that you just want to know the names of the logged-in users and don't care about what terminals they are on or when they logged in. You can use the `cut` command to cut out just the usernames from the `who` command's output:

```
$ who | cut -c1-8                                Extract the first 8 characters
root
steve
george
dawn
$
```

The `-c1-8` option to `cut` specifies that characters 1 through 8 are to be extracted from each line of input and written to standard output.

The following shows how you can tack a `sort` to the end of the preceding pipeline to get a sorted list of the logged-in users:

```
$ who | cut -c1-8 | sort
dawn
george
root
steve
$
```

Note, this is our first three-command pipe. Once you get the concept of output connected to subsequent input, pipes of three, four or more commands are logical and easy to assemble.

If you wanted to see which terminals were currently being used or which pseudo or virtual terminals were in use, you could cut out just the `tty` field from the `who` command output:

```
$ who | cut -c10-16
console
tty02
tty08
tty10
$
```

How did you know that `who` displays the terminal identification in character positions 10 through 16? Simple! You executed the `who` command at your terminal and *counted* out the appropriate character positions.

You can use `cut` to extract as many different characters from a line as you want. Here, `cut` is used to display just the username and login time of all logged-in users:

```
$ who | cut -c1-8,18-
root    Feb 24 08:54
steve   Feb 24 12:55
george  Feb 24 09:15
dawn    Feb 24 15:55
$
```

The option `-c1-8,18-` specifies “extract characters 1 through 8 (the username) and also characters 18 through the end of the line (the login time).”

The `-d` and `-f` Options

The `cut` command with its `-c` flag is useful when you need to extract data from a file or command, provided that file or command has a fixed format.

For example, you could use `cut` with the `who` command because you know that the usernames are always displayed in character positions 1–8, the terminal in 10–16, and the login time in 18–29. Unfortunately, not all your data will be so well organized!

For instance, take a look at the `/etc/passwd` file:

```
$ cat /etc/passwd
root:*:0:0:The Super User:/:usr/bin/ksh
cron:*:1:1:Cron Daemon for periodic tasks:/:
bin:*:3:3:The owner of system files:/:
uucp:*:5:5:/:usr/spool/uucp:/usr/lib/uucp/uucico
asg:*:6:6:The Owner of Assignable Devices:/:
steve:*.:203:100:./users/steve:/usr/bin/ksh
other:*:4:4:Needed by secure program:/:
$
```

`/etc/passwd` is the master file that contains the usernames of all users on your computer system. It also contains other information such as user ID, home directory, and the name of the program to start up when that particular user logs in.

Quite clearly, the data in this file does not line up anywhere near as neatly as the `who`'s output does. Therefore extracting a list of all the users of your system from this file cannot be done using the `-c` option to `cut`.

Upon closer inspection of the file, however, it's clear that fields are separated by a colon character. Although each field may not be the same length from one line to the next, you can “count colons” to get the same field from each line.

The `-d` and `-f` options are used with `cut` when you have data that is delimited by a particular character, with `-d` specifying the field separator delimiter and `-f` the field or fields you want extracted. The invocation of the `cut` command becomes

```
cut -ddchar -ffields file
```

where *dchar* is the character that delimits each field of the data, and *fields* specifies the fields to be extracted from *file*. Field numbers start at 1, and the same type of formats can be used to specify field numbers as was used to specify character positions before (for example, `-f1,2,8`, `-f1-3`, `-f4-`).

To extract the names of all users from `/etc/passwd`, you could type the following:

```
$ cut -d: -f1 /etc/passwd           Extract field 1
root
cron
bin
```

```

uucp
asg
steve
other
$

```

Given that the home directory of each user is in field 6, you can match up each user of the system with their home directory:

```

$ cut -d: -f1,6 /etc/passwd           Extract fields 1 and 6
root:/
cron:/
bin:/
uucp:/usr/spool/uucp
asg:/
steve:/users/steve
other:/
$

```

If the `cut` command is used to extract fields from a file and the `-d` option is not supplied, `cut` uses the tab character as the default field delimiter.

The following depicts a common pitfall when using the `cut` command. Suppose that you have a file called `phonebook` that has the following contents:

```

$ cat phonebook
Alice Chebba    973-555-2015
Barbara Swingle 201-555-9257
Jeff Goldberg   201-555-3378
Liz Stachiw    212-555-2298
Susan Goldberg  201-555-7776
Tony Iannino    973-555-1295
$

```

If you just want to get the names of the people in your phone book, your first impulse would be to use `cut` as shown:

```

$ cut -c1-15 phonebook
Alice Chebba    97
Barbara Swingle
Jeff Goldberg   2
Liz Stachiw    212
Susan Goldberg
Tony Iannino    97
$

```

Not quite what you want! This happened because the name is separated from the phone number by a tab character, not a set of spaces. As far as `cut` is concerned, tabs count as a single character when using the `-c` option. Therefore `cut` extracts the first 15 characters from each line, producing the results shown.

In a situation where the fields are separated by tabs, you should use the `-f` option to `cut` instead:

```
$ cut -f1 phonebook
Alice Chebba
Barbara Swingle
Jeff Goldberg
Liz Stachiw
Susan Goldberg
Tony Iannino
$
```

Recall that you don't have to specify the delimiter character with the `-d` option because `cut` defaults to a tab character delimiter.

How do you know in advance whether fields are delimited by blanks or tabs? One way to find out is by trial and error, as shown previously. Another way is to type the command

```
sed -n 1 file
```

at your terminal. If a tab character separates the fields, `\t` will be displayed instead of the tab:

```
$ sed -n 1 phonebook
Alice Chebba\t973-555-2015
Barbara Swingle\t201-555-9257
Jeff Goldberg\t201-555-3378
Liz Stachiw\t212-555-2298
Susan Goldber\t201-555-7776
Tony Iannino\t973-555-1295
$
```

The output verifies that each name is separated from each phone number by a tab character. The stream editor `sed` is covered in more detail a bit later in this chapter.

paste

The `paste` command is the inverse of `cut`: Instead of breaking lines apart, it puts them together. The general format of the `paste` command is

```
paste files
```

where corresponding lines from each of the specified *files* are “pasted” or merged together to form single lines that are then written to standard output. The dash character `-` can also be used in the *files* sequence to specify that input is from standard input.

Suppose that you have a list of names in a file called `names`:

```
$ cat names
Tony
Emanuel
Lucy
```

```
Ralph
Fred
$
```

Suppose that you also have a second file called `numbers` that contains corresponding phone numbers for each name in `names`:

```
$ cat numbers
(307) 555-5356
(212) 555-3456
(212) 555-9959
(212) 555-7741
(212) 555-0040
$
```

You can use `paste` to print the names and numbers side-by-side as shown:

```
$ paste names numbers           Paste them together
Tony      (307) 555-5356
Emanuel   (212) 555-3456
Lucy      (212) 555-9959
Ralph     (212) 555-7741
Fred      (212) 555-0040
$
```

Each line from `names` is displayed with the corresponding line from `numbers`, separated by a tab.

The next example illustrates what happens when more than two files are specified:

```
$ cat addresses
55-23 Vine Street, Miami
39 University Place, New York
17 E. 25th Street, New York
38 Chauncey St., Bensonhurst
17 E. 25th Street, New York
$ paste names addresses numbers
Tony      55-23 Vine Street, Miami      (307) 555-5356
Emanuel   39 University Place, New York (212) 555-3456
Lucy      17 E. 25th Street, New York  (212) 555-9959
Ralph     38 Chauncey St., Bensonhurst  (212) 555-7741
Fred      17 E. 25th Street, New York  (212) 555-0040
$
```

The `-d` Option

If you don't want the output fields separated by tab characters, you can specify the `-d` option to specify the output delimiter:

```
-dchars
```

where *chars* is one or more characters that will be used to separate the lines pasted together. That is, the first character listed in *chars* will be used to separate lines from the first file that are pasted with lines from the second file; the second character listed in *chars* will be used to separate lines from the second file from lines from the third, and so on.

If there are more files than there are characters listed in *chars*, *paste* “wraps around” the list of characters and starts again at the beginning.

In the simplest form of the `-d` option, specifying just a single delimiter character causes that character to be used to separate *all* pasted fields:

```
$ paste -d'+ ' names addresses numbers
Tony+55-23 Vine Street, Miami+(307) 555-5356
Emanuel+39 University Place, New York+(212) 555-3456
Lucy+17 E. 25th Street, New York+(212) 555-9959
Ralph+38 Chauncey St., Bensonhurst+(212) 555-7741
Fred+17 E. 25th Street, New York+(212) 555-0040
```

Notice that it’s always safest to enclose the delimiter characters in single quotes. The reason why will be explained shortly.

The `-s` Option

The `-s` option tells *paste* to paste together lines from the same file, not from alternate files. If just one file is specified, the effect is to merge all the lines from the file together, separated by tabs, or by the delimiter characters specified with the `-d` option.

```
$ paste -s names           Paste all lines from names
Tony Emanuel Lucy Ralph Fred
$ ls | paste -d' ' -s -    Paste ls's output, use space as delimiter
addresses intro lotsaspaces names numbers phonebook
$
```

In the former example, the output from `ls` is piped to *paste* which merges the lines (`-s` option) from standard input (`-`), separating each field with a space (`-d' '` option). You’ll recall from Chapter 1 that the command

```
echo *
```

would have also listed all the files in the current directory, perhaps *slightly* less complicated than `ls | paste`.

sed

sed is a program used for editing data in a pipe or command sequence. It stands for *stream editor*. Unlike *ed*, *sed* cannot be used interactively, though its commands are similar. The general form of the *sed* command is

```
sed command file
```

where *command* is an *ed*-style command applied to *each* line of the specified *file*. If no file is specified, standard input is assumed.

As *sed* applies the indicated command or commands to each line of the input, it writes the results to standard output.

Let's have a look. First, the *intro* file again:

```
$ cat intro
The Unix operating system was pioneered by Ken
Thompson and Dennis Ritchie at Bell Laboratories
in the late 1960s. One of the primary goals in
the design of the Unix system was to create an
environment that promoted efficient program
development.
$
```

Suppose that you want to change all occurrences of "Unix" in the text to "UNIX." This can be easily done in *sed* as follows:

```
$ sed 's/Unix/UNIX/' intro      Substitute Unix with UNIX
The UNIX operating system was pioneered by Ken
Thompson and Dennis Ritchie at Bell Laboratories
in the late 1960s. One of the primary goals in
the design of the UNIX system was to create an
environment that promoted efficient program
development.
$
```

Get into the habit of enclosing your *sed* command in single quotes. Later, you'll know when the quotes are necessary and when it's better to use double quotes instead.

The *sed* command *s/Unix/UNIX/* is applied to every line of *intro*. Whether or not the line is modified, it gets written to standard output. Since it's in the data stream also note that *sed* makes no changes to the original input file.

To make the changes permanent, you must redirect the output from *sed* into a temporary file and then replace the original file with the newly created one:

```
$ sed 's/Unix/UNIX/' intro > temp  Make the changes
$ mv temp intro                    And now make them permanent
$
```

Always make sure that the correct changes were made to the file before you overwrite the original; a *cat* of *temp* would have been smart before the *mv* command overwrote the original data file.

If your text included more than one occurrence of "Unix" on a line, the above *sed* would have changed just the first occurrence to "UNIX." By appending the *global* option *g* to the end of the substitute command *s*, you can ensure that multiple occurrences on a line will be changed.

In this case, the `sed` command would read

```
$ sed 's/Unix/UNIX/g' intro > temp
```

Now suppose that you wanted to extract just the usernames from the output of `who`. You already know how to do that with the `cut` command:

```
$ who | cut -c1-8
root
ruth
steve
pat
$
```

Alternatively, you can use `sed` to delete all the characters from the first space (which marks the end of the username) through the end of the line by using a regular expression:

```
$ who | sed 's/ .*$//'
root
ruth
steve
pat
$
```

The `sed` command substitutes a blank space followed by any characters up through the end of the line (`.*$`) with *nothing* (`//`); that is, it deletes the characters from the first blank to the end of the line for each input line.

The `-n` Option

By default, `sed` writes each line of input to standard output, whether or not it gets changed. Sometimes, however, you'll want to use `sed` just to extract specific lines from a file. That's what the `-n` flag is for: it tells `sed` that you don't want it to print any lines by default. Paired with that, use the `p` command to print whichever lines match your specified range or pattern. For example, to print just the first two lines from a file:

```
$ sed -n '1,2p' intro           Just print the first 2 lines
The UNIX operating system was pioneered by Ken
Thompson and Dennis Ritchie at Bell Laboratories
$
```

If, instead of line numbers, you precede the `p` command with a sequence of characters enclosed in slashes, `sed` prints just the lines from standard input that match that pattern. The following example shows how `sed` can be used to display just the lines that contain a particular string:

```
$ sed -n '/UNIX/p' intro       Just print lines containing UNIX
The UNIX operating system was pioneered by Ken
the design of the UNIX system was to create an
$
```

Deleting Lines

To delete lines of text, use the `d` command. By specifying a line number or range of numbers, you can delete specific lines from the input. In the following example, `sed` is used to delete the first two lines of text from `intro`:

```
$ sed '1,2d' intro           Delete lines 1 and 2
in the late 1960s. One of the primary goals in
the design of the UNIX system was to create an
environment that promoted efficient program
development.
$
```

Remembering that by default `sed` writes all lines of the input to standard output, the remaining lines in `text`—that is, lines 3 through the end—simply get written to standard output.

By preceding the `d` command with a pattern, you can use `sed` to delete all lines that contain that text. In the following example, `sed` is used to delete all lines of text containing the word `UNIX`:

```
$ sed '/UNIX/d' intro       Delete all lines containing UNIX
Thompson and Dennis Ritchie at Bell Laboratories
in the late 1960s. One of the primary goals in
environment that promoted efficient program
development.
$
```

The power and flexibility of `sed` goes far beyond what we've shown here. `sed` has facilities that enable you to loop, build text in a buffer, and combine many commands into a single editing script. Table 3.2 shows some more examples of `sed` commands.

Table 3.2 `sed` Examples

<code>sed</code> Command	Description
<code>sed '5d'</code>	Delete line 5
<code>sed '/[Tt]est/d'</code>	Delete all lines containing <code>Test</code> or <code>test</code>
<code>sed -n '20,25p' text</code>	Print only lines 20 through 25 from <code>text</code>
<code>sed '1,10s/unix/UNIX/g' intro</code>	Change <code>unix</code> to <code>UNIX</code> wherever it appears in the first 10 lines of <code>intro</code>
<code>sed '/jan/s/-1/-5/'</code>	Change the first <code>-1</code> to <code>-5</code> in all lines containing <code>jan</code>
<code>sed 's/.../' data</code>	Delete the first three characters from each line of <code>data</code>
<code>sed 's/...\$/' data</code>	Delete the last 3 characters from each line of <code>data</code>
<code>sed -n 'l' text</code>	Print all lines from <code>text</code> , showing non-printing characters as <code>\nn</code> (where <code>nn</code> is the octal value of the character), and tab characters as <code>\t</code>

tr

The `tr` filter is used to translate characters from standard input. The general form of the command is

```
tr from-chars to-chars
```

where *from-chars* and *to-chars* are one or more characters or a set of characters. Any character in *from-chars* encountered on the input will be translated into the corresponding character in *to-chars*. The result of the translation is written to standard output.

In its simplest form, `tr` can be used to translate one character into another. Recall the file `intro` from earlier in this chapter:

```
$ cat intro
```

```
The UNIX operating system was pioneered by Ken
Thompson and Dennis Ritchie at Bell Laboratories
in the late 1960s. One of the primary goals in
the design of the UNIX system was to create an
environment that promoted efficient program
development.
```

```
$
```

The following shows how `tr` can be used to translate all letter `e`'s to `x`'s:

```
$ tr e x < intro
```

```
Thx UNIX opxrating systxm was pionxxrxrd by Kxn
Thompson and Dxnnis Ritchix at Bxll Laboratorixs
in thx latx 1960s. Onx of thx primary goals in
thx dxsign of thx UNIX systxm was to crxatx an
xnvironmxnt that promotxd xfficixnt program
dxvxlopmxnt.
```

```
$
```

The input to `tr` must be redirected from the file `intro` because `tr` always expects its input to come from standard input. The results of the translation are written to standard output, leaving the original file untouched. Showing a more practical example, recall the pipeline that you used to extract the usernames and home directories of everyone on the system:

```
$ cut -d: -f1,6 /etc/passwd
```

```
root:/
cron:/
bin:/
uucp:/usr/spool/uucp
asg:/
steve:/users/steve
other:/
```

```
$
```

You can translate the colons into tab characters to produce a more readable output simply by tacking an appropriate `tr` command to the end of the pipeline:

```
$ cut -d: -f1,6 /etc/passwd | tr : ' '
root /
cron /
bin /
uucp /usr/spool/uucp
asg /
steve /users/steve
other /
$
```

Enclosed between the single quotes is a tab character (even though you can't see it—just take our word for it). It must be enclosed in quotes to keep it from being parsed and discarded by the shell as extraneous whitespace.

Working with characters that aren't printable? The octal representation of a character can be given to `tr` in the format

```
\nnn
```

where *nnn* is the octal value of the character. This isn't used too often, but can be handy to remember.

For example, the octal value of the tab character is 11, so another way to accomplish the colon-to-tab transformation is to use the `tr` command

```
tr : '\11'
```

Table 3.3 lists characters that you'll often want to specify in octal format.

Table 3.3 Octal Values of Some ASCII Characters

Character	Octal value
Bell	7
Backspace	10
Tab	11
Newline	12
Linefeed	12
Formfeed	14
Carriage Return	15
Escape	33

In the following example, `tr` takes the output from `date` and translates all spaces into newline characters. The net result is that each field of output appears on a different line:

```
$ date | tr ' ' '\12'           Translate spaces to newlines
Sun
```

```

Jul
28
19:13:46
EDT
2002
$

```

`tr` can also translate ranges of characters. For example, the following shows how to translate all lowercase letters in `intro` to their uppercase equivalents:

```

$ tr '[a-z]' '[A-Z]' < intro
THE UNIX OPERATING SYSTEM WAS PIONEERED BY KEN
THOMPSON AND DENNIS RITCHIE AT BELL LABORATORIES
IN THE LATE 1960S. ONE OF THE PRIMARY GOALS IN
THE DESIGN OF THE UNIX SYSTEM WAS TO CREATE AN
ENVIRONMENT THAT PROMOTED EFFICIENT PROGRAM
DEVELOPMENT.
$

```

The character ranges `[a-z]` and `[A-Z]` are enclosed in quotes to keep the shell from interpreting the pattern. Try the command without the quotes and you'll quickly see that the result isn't quite what you seek.

By reversing the two arguments to `tr`, you can use the command to translate all uppercase letters to lowercase:

```

$ tr '[A-Z]' '[a-z]' < intro
the unix operating system was pioneered by ken
thompson and dennis ritchie at bell laboratories
in the late 1960s. one of the primary goals in
the design of the unix system was to create an
environment that promoted efficient program
development.
$

```

For a more interesting example, try to guess what this `tr` invocation accomplishes:

```
tr '[a-zA-Z]' '[A-Za-z]'
```

Figured it out? This turns uppercase letters into lowercase, and lowercase letters into uppercase.

The `-s` Option

You can use the `-s` option to “squeeze” out multiple consecutive occurrences of characters in *to-chars*. In other words, if more than one consecutive occurrence of a character specified in *to-chars* occurs after the translation is made, the characters will be replaced by a single character.

For example, the following command translates all colons into tab characters, replacing multiple tabs with single tabs:

```
tr -s ':' '\11'
```

So one colon or several consecutive colons on the input will be replaced by a *single* tab character on the output.

Note that '\t' can work in many instances instead of '\11', so be sure to try that if you want things to be a bit more readable!

Suppose that you have a file called `lotsaspaces` that has contents as shown:

```
$ cat lotsaspaces
This      is  an example  of a
file  that contains      a lot
of  blank spaces.
$
```

You can use `tr` to squeeze out the multiple spaces by using the `-s` option and by specifying a single space character as the first and second argument:

```
$ tr -s ' ' ' ' < lotsaspaces
This is an example of a
file that contains a lot
of blank spaces.
$
```

This `tr` command in effect says, “translate occurrences of space with another space, replacing multiple spaces in the output with a single space.”

The `-d` Option

`tr` can also be used to delete individual characters from the input stream. The format of `tr` in this case is

```
tr -d from-chars
```

where any character listed in *from-chars* will be deleted from standard input. In the following example, `tr` is used to delete all spaces from the file `intro`:

```
$ tr -d ' ' < intro
TheUNIXoperatingsystemwaspioneeredbyKen
ThompsonandDennisRitchieatBellLaboratories
inthelate1960s.Oneoftheprimarygoalsin
thedesignoftheUNIXSystemwastocreatean
environmentthatpromotedefficientprogram
development.
$
```

You probably realize that you could have also used `sed` to achieve the same results:

```
$ sed 's/ //g' intro
TheUNIXoperatingsystemwaspioneeredbyKen
ThompsonandDennisRitchieatBellLaboratories
inthelate1960s.Oneoftheprimarygoalsin
thedesignoftheUNIXsystemwastocreatean
environmentthatpromotedefficientprogram
```

```
development.
$
```

This is not atypical for the Unix system; there's almost always more than one approach to solving a particular problem. In the case we just saw, either approach is satisfactory (that is, `tr` or `sed`), but `tr` is probably a better choice because it is a much smaller program and likely to execute faster.

Table 3.4 summarizes how to use `tr` for translating and deleting characters. Bear in mind that `tr` works only on *single* characters. So if you need to translate anything longer than a single character (say all occurrences of `unix` to `UNIX`), you have to use a different program, such as `sed`, instead.

Table 3.4 `tr` Examples

<code>tr</code> Command	Description
<code>tr 'X' 'x'</code>	Translate all capital X's to small x's.
<code>tr '()' '{}'</code>	Translate all open parentheses to open braces, all closed parentheses to closed braces
<code>tr '[a-z]' '[A-Z]'</code>	Translate all lowercase letters to uppercase
<code>tr '[A-Z]' '[N-ZA-M]'</code>	Translate uppercase letters A–M to N–Z, and N–Z to A–M, respectively
<code>tr ' ' ' '</code>	Translate all tabs (character in first pair of quotes) to spaces
<code>tr -s ' ' ' '</code>	Translate multiple spaces to single spaces
<code>tr -d '\14'</code>	Delete all formfeed (octal 14) characters
<code>tr -d '[0-9]'</code>	Delete all digits

grep

`grep` allows you to search one or more files for a pattern you specify. The general format of this command is

```
grep pattern files
```

Every line of each file that contains *pattern* is displayed at the terminal. If more than one file is specified to `grep`, each line is also preceded by the name of the file, thus enabling you to identify the particular file that the pattern was found in.

Let's say that you want to find every occurrence of the word `shell` in the file `ed.cmd`:

```
$ grep shell ed.cmd
files, and is independent of the shell.
to the shell, just type in a q.
$
```

This output indicates that two lines in the file `ed.cmd` contain the word `shell`.

If the pattern does not exist in the specified file(s), the `grep` command simply displays nothing:

```
$ grep cracker ed.cmd
$
```

You saw in the section on `sed` how you could print all lines containing the string `UNIX` from the file `intro` with the command

```
sed -n '/UNIX/p' intro
```

But you could also use the following `grep` command to achieve the same result:

```
grep UNIX intro
```

Recall the `phonebook` file from before:

```
$ cat phonebook
Alice Chebba 973-555-2015
Barbara Swingle 201-555-9257
Jeff Goldberg 201-555-3378
Liz Stachiw 212-555-2298
Susan Goldberg 201-555-7776
Tony Iannino 973-555-1295
$
```

When you need to look up a particular phone number, the `grep` command comes in handy:

```
$ grep Susan phonebook
Susan Goldberg 201-555-7776
$
```

The `grep` command is particularly useful when you have a lot of files and you want to find out which ones contain certain words or phrases. The following example shows how the `grep` command can be used to search for the word `shell` in *all* files in the current directory:

```
$ grep shell *
cmdfiles:shell that enables sophisticated
ed.cmd:files, and is independent of the shell.
ed.cmd:to the shell, just type in a q.
grep.cmd:occurrence of the word shell:
grep.cmd:$ grep shell *
grep.cmd:every use of the word shell.
$
```

As noted, when more than one file is specified to `grep`, each output line is preceded by the name of the file containing that line.

As with expressions for `sed` and patterns for `tr`, it's a good idea to enclose your `grep` pattern inside a pair of *single* quotes to “protect” it from the shell. Here's an example of what can happen if you don't: say you want to find all the lines containing asterisks inside the file `stars`; typing

```
grep * stars
```

doesn't work as you'd hope because the shell sees the asterisk and automatically substitutes the names of all the files in your current directory!

```
$ ls
circles
polka.dots
squares
stars
stripes
$ grep * stars
$
```

In this case, the shell took the asterisk and substituted the list of files in your current directory. Then it started execution of `grep`, which took the first argument (`circles`) and tried to find it in the files specified by the remaining arguments, as shown in Figure 3.1.

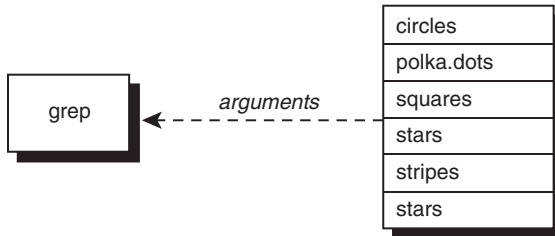

Figure 3.1 `grep * stars`

Enclosing the asterisk in quotes, however, blocks it from being parsed and interpreted by the shell:

```
$ grep '*' stars
The asterisk (*) is a special character that
*****
5 * 4 = 20
$
```

The quotes told the shell to leave the enclosed characters alone. It then started execution of `grep`, passing it the two arguments `*` (without the surrounding quotes; the shell removes them in the process) and `stars` (see Figure 3.2).

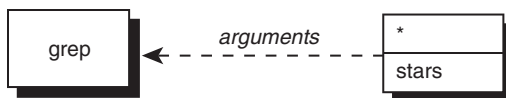

Figure 3.2 `grep '*' stars`

There are characters other than `*` that have a special meaning to the shell and must be quoted when used in a pattern. The whole topic of how quotes are handled by the shell is admittedly tricky; an entire chapter—Chapter 5—is devoted to it.

`grep` takes its input from standard input if no filename is specified. So you can use `grep` as part of a pipe to scan through the output of a command for lines that match a specific pattern. Suppose that you want to find out whether the user `jim` is logged in. You can use `grep` to search through `who`'s output:

```
$ who | grep jim
jim          tty16          Feb 20 10:25
$
```

Note that by not specifying a file to search, `grep` automatically scans standard input. Naturally, if the user `jim` were not logged in, you would get a new command prompt without any preceding output:

```
$ who | grep jim
$
```

Regular Expressions and `grep`

Let's take another look at the `intro` file:

```
$ cat intro
The UNIX operating system was pioneered by Ken
Thompson and Dennis Ritchie at Bell Laboratories
in the late 1960s. One of the primary goals in
the design of the UNIX system was to create an
environment that promoted efficient program
development.
$
```

`grep` allows you to specify your pattern using regular expressions as in `ed`. Given this information, it means that you can specify the pattern

```
[tT]he
```

to have `grep` search for either a lower- or uppercase `T` followed by the characters `he`.

Here's how to use `grep` to list all the lines containing the characters `the` or `The`:

```
$ grep '[tT]he' intro
The UNIX operating system was pioneered by Ken
in the late 1960s. One of the primary goals in
the design of the UNIX system was to create an
$
```

A smarter alternative might be to utilize the `-i` option to `grep` which makes patterns case insensitive. That is, the command

```
grep -i 'the' intro
```

tells `grep` to ignore the difference between upper and lowercase when matching the pattern against the lines in `intro`. Therefore, lines containing `the` or `The` will be printed, as will lines containing `THE`, `THE`, `tHE`, and so on.

Table 3.5 shows other types of regular expressions that you can specify to `grep` and the types of patterns they'll match.

Table 3.5 Some `grep` Examples

Command	Prints
<code>grep '[A-Z]' list</code>	Lines from <code>list</code> containing a capital letter
<code>grep '[0-9]' data</code>	Lines from <code>data</code> containing a digit
<code>grep '[A-Z]...[0-9]' list</code>	Lines from <code>list</code> containing five-character patterns that start with a capital letter and end with a digit
<code>grep '\.pic\$' filelist</code>	Lines from <code>filelist</code> that end with <code>.pic</code>

The `-v` Option

Sometimes you're interested not in finding the lines that contain a specified pattern, but those that *don't*. That's what the `-v` option is for with `grep`: to *reverse* the logic of the matching task. In the next example, `grep` is used to find all the lines in `intro` that don't contain the pattern `UNIX`.

```
$ grep -v 'UNIX' intro           Print all lines that don't contain UNIX
Thompson and Dennis Ritchie at Bell Laboratories
in the late 1960s. One of the primary goals in
environment that promoted efficient program
development.
$
```

The `-l` Option

At times, you may not want to see the actual lines that match a pattern but just seek the names of the files that contain the pattern. For example, suppose that you have a set of C programs in your current directory (by convention, these filenames end with the filename suffix `.c`), and you want to know which use a variable called `Move_history`. Here's one way of finding the answer:

```
$ grep 'Move_history' *.c           Find Move_history in all C source files
exec.c:MOVE      Move_history[200] = {0};
exec.c:      cpymove(&Move_history[Number_half_moves -1],
exec.c:      undo_move(&Move_history[Number_half_moves-1],);
exec.c:      cpymove(&last_move,&Move_history[Number_half_moves-1]);
exec.c:      convert_move(&Move_history[Number_half_moves-1]),
exec.c:      convert_move(&Move_history[i-1]),
```

```

exec.c: convert_move(&Move_history[Number_half_moves-1]),
makemove.c:IMPORT MOVE Move_history[];
makemove.c:    if ( Move_history[j].from != BOOK (i,j,from) OR
makemove.c:        Move_history[j].to != BOOK (i,j,to) )
testch.c:GLOBAL MOVE Move_history[100] = {0};
testch.c:    Move_history[Number_half_moves-1].from = move.from;
testch.c:    Move_history[Number_half_moves-1].to = move.to;
$

```

Sifting through the preceding output, you discover that three files—`exec.c`, `makemove.c`, and `testch.c`—use the variable.

Add the `-l` option to `grep` and you instead get a list of files that contain the specified pattern, not the matching lines from the files:

```

$ grep -l 'Move_history' *.c           List the files that contain Move_history
exec.c
makemove.c
testch.c
$

```

Because `grep` conveniently lists the files one per line, you can pipe the output from `grep -l` into `wc` to count the *number* of *files* that contain a particular pattern:

```

$ grep -l 'Move_history' *.c | wc -l
3
$

```

The preceding command shows that precisely three C program files reference the variable `Move_history`. Now, just to make sure you're paying attention, what are you counting if you use `grep` *without* the `-l` option and pipe the output to `wc -l`?

The `-n` Option

If the `-n` option is used with `grep`, each line from the file that matches the specified pattern is preceded by its corresponding line number. From previous examples, you saw that the file `testch.c` was one of the three files that referenced the variable `Move_history`; the following shows how you can pinpoint the precise lines in the file that reference the variable:

```

$ grep -n 'Move_history' testch.c      Precede matches with line numbers
13:GLOBAL MOVE Move_history[100] = {0};
197:    Move_history[Number_half_moves-1].from = move.from;
198:    Move_history[Number_half_moves-1].to = move.to;
$

```

As you can see, `Move_history` is used on lines 13, 197, and 198 in `testch.c`.

For Unix experts, `grep` is one of the most commonly used programs because of its flexibility and sophistication with pattern matching. It's one well worth studying.

sort

At its most basic, the `sort` command is really easy to understand: give it lines of input and it'll sort them alphabetically, with the result appearing as its output:

```
$ sort names
Charlie
Emanuel
Fred
Lucy
Ralph
Tony
Tony
$
```

By default, `sort` takes each line of the specified input file and sorts it into ascending order.

Special characters are sorted according to the internal encoding of the characters. For example, the space character is represented internally as the number 32, and the double quote as the number 34. This means that the former would be sorted before the latter. Particularly for other languages and locales the sorting order can vary, so although you are generally assured that `sort` will perform as expected on alphanumeric input, the ordering of foreign language characters, punctuation, and other special characters is not always what you might expect.

`sort` has many options that provide more flexibility in performing your sort. We'll just describe a few of the options here.

The `-u` Option

The `-u` option tells `sort` to eliminate duplicate lines from the output.

```
$ sort -u names
Charlie
Emanuel
Fred
Lucy
Ralph
Tony
$
```

Here you see that the duplicate line that contained `Tony` was eliminated from the output. A lot of old-school Unix people accomplish the same thing by using the separate program `uniq`, so if you read system shell scripts you'll often see sequences like `sort | uniq`. Those can be replaced with `sort -u!`

The `-r` Option

Use the `-r` option to *reverse* the order of the sort:

```
$ sort -r names          Reverse sort
Tony
Tony
Ralph
Lucy
Fred
Emanuel
Charlie
$
```

The `-o` Option

By default, `sort` writes the sorted data to standard output. To have it go into a file, you can use output redirection:

```
$ sort names > sorted_names
$
```

Alternatively, you can use the `-o` option to specify the output file. Simply list the name of the output file right after the `-o`:

```
$ sort names -o sorted_names
$
```

This sorts `names` and writes the results to `sorted_names`.

What's the value of the `-o` option? Frequently, you want to sort the lines in a file and have the sorted data replace the original. But typing

```
$ sort names > names
$
```

won't work—it ends up wiping out the `names` file! However, with the `-o` option, it is okay to specify the same name for the output file as the input file:

```
$ sort names -o names
$ cat names
Charlie
Emanuel
Fred
Lucy
Ralph
Tony
Tony
$
```

Tip

Be careful if your filter or process is going to replace your original input file and make sure that it's all working as you expect prior to having the data overwritten. Unix is good at a lot of things, but there's no *unremove* command to recover lost data or lost files.

The -n Option

Suppose that you have a file containing pairs of (x, y) data points as shown:

```
$ cat data
5      27
2      12
3      33
23     2
-5     11
15     6
14     -9
$
```

And suppose that you want to feed this data into a plotting program called `plotdata`, but that the program requires that the incoming data pairs be sorted in increasing value of x (the first value on each line).

The `-n` option to `sort` specifies that the first field on the line is to be considered a *number*, and the data is to be sorted arithmetically. Compare the output of `sort` used without the `-n` option and then with it:

```
$ sort data
-5     11
14     -9
15     6
2      12
23     2
3      33
5      27
$ sort -n data           Sort arithmetically
-5     11
2      12
3      33
5      27
14     -9
15     6
23     2
$
```

Skipping Fields

If you had to sort your data file by the *y* value—that is, the second number in each line—you could tell `sort` to start with the second field by using the option

-k2n

instead of `-n`. The `-k2` says to skip the first field and start the sort analysis with the second field of each line. Similarly, `-k5n` would mean to start with the fifth field on each line and then sort the data numerically.

```
$ sort -k2n data           Start with the second field in the sort
14      -9
23      2
15      6
-5      11
2       12
5       27
3       33
$
```

Fields are delimited by space or tab characters by default. If a different delimiter is to be used, the `-t` option must be used.

The `-t` Option

As mentioned, if you skip over fields, `sort` assumes that the fields are delimited by space or tab characters. The `-t` option can indicate otherwise. In this case, the character that follows the `-t` is taken as the delimiter character.

Consider the sample password file again:

```
$ cat /etc/passwd
root:*:0:0:The super User:/:usr/bin/ksh
steve:*:203:100::/users/steve:/usr/bin/ksh
bin:*:3:3:The owner of system files:/:
cron:*:1:1:Cron Daemon for periodic tasks:/:
george:*:75:75::/users/george:/usr/lib/rsh
pat:*:300:300::/users/pat:/usr/bin/ksh
uucp:nc823ciSiLiZM:5:5::/usr/spool/uucppublic:/usr/lib/uucp/uucico
asg:*:6:6:The Owner of Assignable Devices:/:
sysinfo:*:10:10:Access to System Information:/:usr/bin/sh
mail:*:301:301::/usr/mail:
$
```

If you wanted to sort this file by username (the first field on each line), you could just issue the command

```
sort /etc/passwd
```

To sort the file instead by the third colon-delimited field (which contains what is known as your *user ID*), you would want an arithmetic sort, starting with the third field (`-k3`), and specifying the colon character as the field delimiter (`-t:`):

```
$ sort -k3n -t: /etc/passwd          Sort by user id
root:*:0:0:The Super User:/:usr/bin/ksh
cron:*:1:1:Cron Daemon for periodic tasks:/:
bin:*:3:3:The owner of system files:/:
uucp:*:5:5:./usr/spool/uucppublic:/usr/lib/uucp/uucico
asg:*:6:6:The Owner of Assignable Devices:/:
sysinfo:*:10:10:Access to System Information:/:usr/bin/sh
george:*:75:75:./users/george:/usr/lib/rsh
steve:*:203:100:./users/steve:/usr/bin/ksh
pat:*:300:300:./users/pat:/usr/bin/ksh
mail:*:301:301:./usr/mail: .
$
```

Here we've bolded the third field of each line so that you can easily verify that the file was sorted correctly by user *ID*.

Other Options

Other options to `sort` enable you to skip characters within a field, specify the field to *end* the sort on, merge sorted input files, and sort in “dictionary order” (only letters, numbers, and spaces are used for the comparison). For more details on these options, look under `sort` in your *Unix User's Manual*.

uniq

The `uniq` command is useful when you need to find or remove duplicate lines in a file. The basic format of the command is

```
uniq in_file out_file
```

In this format, `uniq` copies *in_file* to *out_file*, removing any duplicate lines in the process. `uniq`'s definition of duplicated lines is *consecutive lines that match exactly*.

If *out_file* is not specified, the results will be written to standard output. If *in_file* is also not specified, `uniq` acts as a filter and reads its input from standard input.

Here are some examples to see how `uniq` works. Suppose that you have a file called `names` with contents as shown:

```
$ cat names
Charlie
Tony
Emanuel
Lucy
```

```
Ralph
Fred
Tony
$
```

You can see that the name `Tony` appears twice in the file. You can use `uniq` to remove such duplicate entries:

```
$ uniq names           Print unique lines
Charlie
Tony
Emanuel
Lucy
Ralph
Fred
Tony
$
```

Oops! `Tony` still appears twice in the preceding output because the multiple occurrences are not *consecutive* in the file, and thus `uniq`'s definition of duplicate is not satisfied. To remedy this situation, `sort` is often used to get the duplicate lines adjacent to each other, as mentioned earlier in the chapter. The result of the `sort` is then run through `uniq`:

```
$ sort names | uniq
Charlie
Emanuel
Fred
Lucy
Ralph
Tony
$
```

The `sort` moves the two `Tony` lines together, and then `uniq` filters out the duplicate line (but recall that `sort` with the `-u` option performs precisely this function).

The `-d` Option

Frequently, you'll be interested in finding just the duplicate entries in a file. The `-d` option to `uniq` can be used for such purposes: It tells `uniq` to write *only* the duplicated lines to `out_file` (or standard output). Such lines are written just once, no matter how many consecutive occurrences there are.

```
$ sort names | uniq -d           List duplicate lines
Tony
$
```

As a more practical example, let's return to our `/etc/passwd` file. This file contains information about each user on the system. It's conceivable that over the course of adding and removing users from this file that perhaps the same username has been inadvertently entered

more than once. You can easily find such duplicate entries by first sorting `/etc/passwd` and piping the results into `uniq -d` as done previously:

```
$ sort /etc/passwd | uniq -d          Find duplicate entries in /etc/passwd
$
```

There are no duplicate full line `/etc/passwd` entries. But you really want to find duplicate entries for the username field, so you only want to look at the first field from each line (recall that the leading characters of each line of `/etc/passwd` up to the colon are the username). This can't be done directly through an option to `uniq`, but can be accomplished by using `cut` to extract the username from each line of the password file before sending it to `uniq`.

```
$ sort /etc/passwd | cut -f1 -d: | uniq -d  Find duplicates
cem
harry
$
```

It turns out that there are multiple entries in `/etc/passwd` for `cem` and `harry`. If you wanted more information on the particular entries, you could now `grep` them from `/etc/passwd`:

```
$ grep -n 'cem' /etc/passwd
20:cem:*:91:91:./users/cem:
166:cem:*:91:91:./users/cem:
$ grep -n 'harry' /etc/passwd
29:harry:*:103:103:Harry Johnson:/users/harry:
79:harry:*:90:90:Harry Johnson:/users/harry:
$
```

The `-n` option was used to find out where the duplicate entries occur. In the case of `cem`, there are two entries on lines 20 and 166; in `harry`'s case, the two entries are on lines 29 and 79.

Other Options

The `-c` option to `uniq` adds an occurrence count, which can be tremendously useful in scripts:

```
$ sort names | uniq -c          Count line occurrences
  1 Charlie
  1 Emanuel
  1 Fred
  1 Lucy
  1 Ralph
  2 Tony
$
```

One common use of `uniq -c` is to figure out the most common words in a data file, easily done with a command like:

```
tr '[A-Z]' '[a-z]' datafile | sort | uniq -c | head
```

Two other options that we don't have space to describe more fully let you tell `uniqu` to ignore leading characters/fields on a line. For more information, consult the man page for your particular implementation of `uniqu` with the command `man uniqu`.

We would be remiss if we neglected to mention the programs `awk` and `perl`, which can be useful when writing shell programs too. They are both big, complicated programming environments unto themselves, however, so we're going to encourage you to check out *Awk—A Pattern Scanning and Processing Language*, by Aho, et al., in the *Unix Programmer's Manual, Volume II* for a description of `awk`, and *Learning Perl* and *Programming Perl*, both from O'Reilly and Associates, offering a good tutorial and reference on the language, respectively.

This page intentionally left blank

And Away We Go

Based on our discussions in Chapter 2, “What Is the Shell?,” you should now realize that whenever you type something like

```
who | wc -l
```

you are actually programming in the shell. That’s because the shell is interpreting the command line, recognizing the pipe symbol, connecting the output of the first command to the input of the second, and initiating execution of both commands.

In this chapter, you’ll learn how to write your own commands and how to use shell *variables*.

Command Files

A shell program can be typed directly, as in

```
$ who | wc -l
```

or it can be typed into a file and then the file can be executed by the shell. For example, suppose that you need to find out the number of logged-in users several times throughout the day. It’s not unreasonable to type in the preceding pipeline each time you want the information, but for the sake of example, let’s type this pipeline into a file.

We’ll call the file `nu` (for *number of users*), and its contents will be just the pipeline shown previously:

```
$ cat nu
who | wc -l
$
```

To execute the commands contained inside the file `nu`, all you now have to do is type `nu` as the command name to the shell:

```
$ nu
sh: nu: cannot execute
$
```

Oops! We forgot to mention one thing. Before you can execute a script from the command line, you must change the file's permission to make it *executable*. This is done with the change mode command, `chmod`. To add execute permission to the file `nu`, you simply type

```
chmod +x file(s)
```

The `+x` indicates that you want to make the *file(s)* that follow executable. The shell requires that a file be *both* readable and executable by you before you can invoke it directly on the command line.

```
$ ls -l nu
-rw-rw-r--  1 steve  steve   12 Jul 10 11:42 nu
$ chmod +x nu
             Make it executable
$ ls -l nu
-rwxrwxr-x  1 steve  steve   12 Jul 10 11:42 nu
$
```

Now that you've made it executable, try it again:

```
$ nu
      8
$
```

This time it worked.

Warning

If you fix the permission issue and still get an error “Command not found,” try adding `./` before the command, like `./nu` to ensure the shell looks in the current directory for commands as well as the usual system locations. To fix it long term, add `.` to the end of your `PATH` (typically within your `.profile` file).

You can put any commands inside a file, make the file executable, and then execute its contents simply by typing its name to the shell. It's that simple and that powerful, and everything you've learned about working on the command line therefore also applies to writing shell scripts too.

The standard shell mechanisms such as I/O redirection and pipes can be used on your own programs as well:

```
$ nu > tally
$ cat tally
      8
$
```

Suppose that you're working on a proposal called `sys.caps` and the following command sequence is needed every time you print the proposal:

```
tbl sys.caps | nroff -mm -Tlp | lp
```

You can save yourself some typing by placing this command sequence into a file—let's call it `run`—making it executable, and then just typing the name `run` whenever you want to print a new copy of the proposal:

```
$ cat run
tbl sys.caps | nroff -mm -Tlp | lp
$ chmod +x run
$ run
request id is laser1-15 (standard input)
$
```

(The `request id` message in the example is from the `lp` command.)

For the next example, suppose that you want to write a shell program called `stats` that prints the date and time, the number of users logged in, and your current working directory. The three command sequences you need to get this information are `date`, `who | wc -l`, and `pwd`:

```
$ cat stats
date
who | wc -l
pwd
$ chmod +x stats
$ stats
Wed Jul 10 11:55:50 EDT 2002
    13
/users/steve/documents/proposals
$
```

Try it out

You can add some `echo` commands to `stats` to make the output a bit more informative:

```
$ cat stats
echo The current date and time is:
date
echo
echo The number of users on the system is:
who | wc -l
echo
echo Your current working directory is:
pwd
$ stats
The current date and time is:
Wed Jul 10 12:00:27 EDT 2002

The number of users on the system is:
    13

Your current working directory is:
/users/steve/documents/proposals
$
```

Execute it

Recall that `echo` without any arguments produces a blank line. Shortly, you'll see how to have the message and command output displayed on the same line, like this:

```
The current date and time is: Wed Jul 10 12:00:27 EDT 2002
```

Comments

The shell programming language would not be complete without a *comment* statement. A comment is a way for you to insert remarks or comments inside the program that otherwise have no effect on its execution.

Whenever the shell encounters the special character `#`, it ignores whatever characters appear starting with the `#` through to the end of the line. If the `#` starts the line, the entire line is treated as a comment. Here are examples of valid comments:

```
# Here is an entire commentary line
who | wc -l          # count the number of users
#
# Test to see if the correct arguments were supplied
#
```

Comments are useful for documenting commands or sequences of commands whose purposes may not be obvious or are sufficiently complex that you might forget why they're there or what they do. Judicious use of comments can also help make shell programs easier to debug and to maintain—both by you and by someone else who may have to support your programs.

Let's go back to the `stats` program and insert some comments and blank lines for legibility:

```
$ cat stats
#
# stats -- prints: date, number of users logged on,
#          and current working directory
#

echo The current date and time is:
date

echo
echo The number of users on the system is:
who | wc -l

echo
echo Your current working directory is:
pwd
$
```

The extra blank lines cost little in terms of program space yet add much in terms of program readability. They're simply ignored by the shell.

Variables

Like virtually all programming languages, the shell allows you to store values into *variables*. A shell variable begins with an alphabetic or underscore (`_`) character and is followed by zero or more alphanumeric or underscore characters.

Note

The regular expression for a shell variable name is therefore `[A-Za-z_][a-zA-Z0-9_]*`, right?

To store a value inside a shell variable, you write the name of the variable, followed immediately by the equals sign `=`, followed immediately by the value you want to store in the variable:

```
variable=value
```

For example, to assign the value `1` to the shell variable `count`, you simply write

```
count=1
```

and to assign the value `/users/steve/bin` to the shell variable `my_bin`, you write

```
my_bin=/users/steve/bin
```

A few important points here. First, spaces are not permitted on either side of the equals sign. Keep that in mind, especially if you've worked in other programming languages and you're in the habit of inserting spaces around operators. In the shell language, you can't put those spaces in.

Second, unlike most other programming languages, the shell has no concept of *data types*. Whenever you assign a value to a shell variable, no matter what it is, the shell simply interprets that value as a string of characters. So when you assigned `1` to the variable `count`, the shell simply stored the *character* `1` inside the variable `count`, making no assumption that an integer value was being stored in the variable.

If you're used to programming in a language such as C, Perl, Swift, or Ruby where all variables must be *declared*, you're in for another adjustment: Because the shell has no concept of data types, variables are not declared before they're used; they're simply assigned values when you want to use them.

The shell does support integer operations on shell variables that contain strings that are also valid numbers through special built-in operations, but even then, the variable is continually evaluated to ensure it's a valid number.

Because the shell is an interpretive language, you can assign values to variables directly at your terminal:

```
$ count=1           Assign character 1 to count
$ my_bin=/users/steve/bin  Assign /users/steve/bin to my_bin
$
```

So now that you know how to assign values to variables, what good is it? Glad you asked.

Displaying the Values of Variables

The `echo` command—which we’ve used already to print values such as strings received from standard input—is used to display the value stored inside a shell variable. To do this, you simply write

```
echo $variable
```

The `$` character is a special character to the shell when followed by one or more alphanumeric characters. If a variable name follows the `$`, the shell takes this as an indication that the value stored inside that variable is to be substituted at that point. So, when you type

```
echo $count
```

the shell replaces `$count` with the value stored there; then it executes the `echo` command:

```
$ echo $count
1
$
```

Remember, the shell performs variable substitution *before* it executes the command (see Figure 4.1).

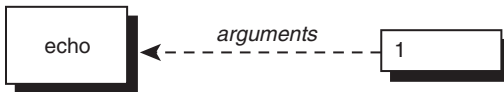

Figure 4.1 `echo $count`

You can have the value of more than one variable substituted at a time:

```
$ echo $my_bin
/users/steve/bin
$ echo $my_bin $count
/users/steve/bin 1
$
```

In the second example, the shell substitutes the values of `my_bin` and `count` and then executes the `echo` command (see Figure 4.2).

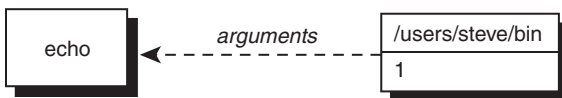

Figure 4.2 `echo $my_bin $count`

Variables can be used anywhere on any command line and will be replaced with their value by the shell prior to the specific command being invoked, as the next examples illustrate:

```
$ ls $my_bin
mon
nu
testx
$ pwd                               Where are we?
/users/steve/documents/memos
$ cd $my_bin                         Change to my bin directory
$ pwd
/users/steve/bin
$ number=99
$ echo There are $number bottles of beer on the wall
There are 99 bottles of beer on the wall
$
```

Here are some more examples:

```
$ command=sort
$ $command names
Charlie
Emanuel
Fred
Lucy
Ralph
Tony
Tony
$ command=wc
$ option=-l
$ file=names
$ $command $option $file
    7 names
$
```

So you see, even the name of a command can be stored inside a variable. Because the shell performs its substitution before determining the name of the program to execute and its arguments, it parses the line

```
$command $option $file
```

then makes all the substitutions requested, turning the command it actually invokes into

```
wc -l names
```

Then the shell executes `wc`, passing the two arguments `-l` and `names`.

Variables can even be assigned to other variables, as shown in the next example:

```
$ value1=10
$ value2=value1
$ echo $value2
```

```
value1                                Didn't do that right
$ value2=$value1
$ echo $value2
10                                     That's better
$
```

Remember that a dollar sign must always be placed before the variable name whenever you want to use the value stored in that variable.

Undefined Variables Have the Null Value

What do you think happens when you try to display the value of a variable that has no value assigned to it? Try it and see:

```
$ echo $nosuch                         Never assigned it a value
$
```

You don't get an error message. Did the `echo` command display anything at all? Let's see whether we can more precisely determine that:

```
$ echo :$nosuch:                       Surround its value with colons
::
$
```

So you see *no* characters were substituted by the shell for the unspecified value of `nosuch`.

A variable that contains no value is said to be undefined and contain the *null* value. It is the default case for variables that you never store values in. When the shell performs its variable substitution, any values that are null are effectively just removed from the command line (which makes sense if they have the null value):

```
$ wc $nosuch -l $nosuch $nosuch names
    7 names
$
```

The shell scans the command line substituting the null value for the variable `nosuch`. After the scan is completed, the line effectively looks like this:

```
wc -l names
```

which explains why it works.

Sometimes you may want to initialize the value of a variable to be the value null. This can be done by simply assigning no value to the variable, as in

```
dataflag=
```

Alternatively, and as a better practice, you can list two adjacent pairs of quotes after the `=`. So

```
dataflag=""
```

and

```
dataflag=''
```

both have the same effect of assigning the null value to `dataflag` and have the added benefit that it looks like it's deliberate, rather than in the first instance where it might be perceived later as a mistake or typo.

Be advised that the assignment

```
dataflag=" "
```

is *not* equivalent to the three previous ones because it assigns a single space character to `dataflag`; that's different from assigning *no* characters to it.

Filename Substitution and Variables

Here's a puzzle for you: If you type

```
x=*
```

will the shell store the character `*` into the variable `x`, or will it store the names of all the files in your current directory into the variable `x`? Let's try it out and see:

```
$ ls
addresses
intro
lotsaspaces
names
nu
numbers
phonebook
stat
$ x=*
$ echo $x
addresses intro lotsaSpaces names nu numbers phonebook stat
$
```

What files do we have?

There's a lot to be learned from this simple example. Was the list of files stored into the variable `x` when

```
x=*
```

was executed, or did the shell do the substitution when

```
echo $x
```

was executed?

It turns out that the shell does not perform filename substitution when assigning values to variables. Therefore,

```
x=*
```

assigns the single character `*` to `x`. This means that given the output shown, the shell must have done the filename substitution when executing the `echo` command. In fact, the precise sequence of steps that occurred when

```
echo $x
```

was executed is as follows:

1. The shell scanned the line, substituting `*` as the value of `x`.
2. The shell rescanned the line, encountered the `*`, and then substituted the names of all files in the current directory.
3. The shell initiated execution of `echo`, passing it the file list as arguments (see Figure 4.3).

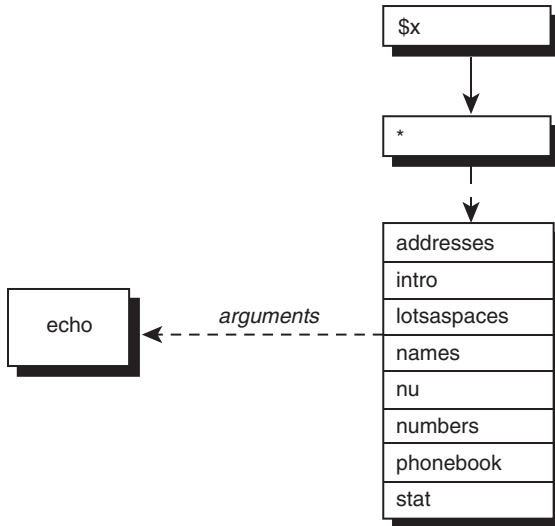

Figure 4.3 `echo $x`

This order of evaluation is important. Remember, first the shell does variable substitution, then does filename substitution, and then parses the line into arguments.

The `${variable}` Construct

Suppose that you have the name of a file stored in the variable `filename`. If you wanted to rename that file so that the new name was the same as the old, except with an `x` added to the end, your first impulse would be to type

```
mv $filename $filenameX
```

When the shell scans this command line, however, it substitutes the value of the variable `filename` *and also the value of the variable* `filenameX`. The shell thinks `filenameX` is the full name of the variable because it's composed entirely of valid characters.

To avoid this problem, delimit the variable by enclosing the entire name (but not the leading dollar sign) in curly braces, as in

```
{filename}X
```

This removes any ambiguity, and the `mv` command then works as desired:

```
mv $filename ${filename}X
```

Remember that the braces are necessary only if the last character of the variable name is followed by an alphanumeric character or an underscore.

There are also quite a few functions applicable to variables within this curly brace notation, including extracting subsets, assigning values if the variable is currently unassigned, and more. Stay tuned for those!

Built-in Integer Arithmetic

The POSIX standard shell as included with all modern Unix and Linux variants (including Mac OS X's command shell) provides a mechanism for performing integer arithmetic on shell variables called *arithmetic expansion*. Note that some older shells do not support this feature.

The format for arithmetic expansion is

```
$(expression)
```

where *expression* is an arithmetic expression using shell variables and operators. Valid shell variables are those that contain numeric values (leading and trailing whitespace is allowed). Valid operators are taken from the C programming language and are listed in Appendix A, "Shell Summary."

`$(()` Operators

There is a surprisingly extensive list of operators, including the basic six: `+`, `-`, `*`, `/`, `%` and `**`, along with more sophisticated notations including `+=`, `-=`, `*=`, `/=`, easy increment and decrement with `variable++` and `variable--`, and more.

Our favorite? You can work with different numerical bases and even convert from one number base to another. For example, here are the answers to what 100 octal (base 8) and 101010101010101010 binary (base 2) are in decimal:

```
$ echo $(( 8#100 ))
64
$ echo $(( 2#101010101010101010 ))
174762
```

The result of computing *expression* is substituted on the command line. For example,

```
echo $(i+1)
```

adds one to the value in the shell variable `i` and prints the result. Notice that the variable `i` doesn't have to be preceded by a dollar sign because the shell knows that the only valid elements that can appear in arithmetic expansions are operators, numbers, and variables. If the

variable is not defined or contains a NULL string, its value is assumed to be zero. So if we have not assigned any value yet to the variable `a`, we can still use it in an integer expression:

```
$ echo $a                                Variable a not set
$ echo $(( a = a + 1 ))                   Equivalent to a = 0 + 1
$ 1
$ echo $a
1                                          Now a contains 1
$
```

Note that assignment is a valid operator, and the value of the assignment is substituted in the second `echo` command in the preceding example.

Parentheses may be used freely inside expressions to force grouping, as in

```
echo $((i = (i + 10) * j))
```

If you want to perform an assignment without `echo` or some other command, you can move the assignment *before* the arithmetic expansion.

So to multiply the variable `i` by 5 and assign the result back to `i` you can write

```
i=$(( i * 5 ))
```

Note that spaces are optional inside the double parentheses, but are not allowed when the assignment is outside them.

A more succinct way to multiply `$i` by 5 is the following common notation, which would appear within another statement:

```
$(( i *= 5 ))
```

If you're just adding 1 to the value, you can be even more succinct:

```
$(( i++ ))
```

Finally, to test to see whether `i` is greater than or equal to 0 and less than or equal to 100, you can write

```
result=$(( i >= 0 && i <= 100 ))
```

which assigns `result` the value of 1 (true) if the expression is true or 0 (false) if it's false:

```
$ i=$(( 100 * 200 / 10 ))
$ j=$(( i < 1000 ))           If i is < 1000, set j = 0; otherwise 1
$ echo $i $j
2000 0                       i is 2000, so j was set to 0
$
```

That concludes our introduction to writing commands and using variables. The next chapter goes into detail on the various quoting mechanisms in the shell.

Can I Quote You on That?

This chapter teaches you about a unique feature of the shell programming language: the way it interprets quote characters. The shell recognizes four different types of quote characters:

- The single quote character `'`
- The double quote character `"`
- The backslash character `\`
- The back quote character ```

The first two and the last characters in the preceding list must occur in pairs, while the backslash character can be used any number of times in a command as needed. Each of these quotes has a distinct meaning to the shell. We'll cover them in separate sections of this chapter.

The Single Quote

There are many reasons that you'll need to use quotes in the shell. One of the most common is to keep character sequences that include whitespace together as a single element.

Here's a file called `phonebook` that contains names and phone numbers:

```
$ cat phonebook
Alice Chebba 973-555-2015
Barbara Swingle 201-555-9257
Liz Stachiw 212-555-2298
Susan Goldberg 201-555-7776
Susan Topple 212-555-4932
Tony Iannino 973-555-1295
$
```

To look up someone in our `phonebook` file you could use `grep`:

```
$ grep Alice phonebook
Alice Chebba 973-555-2015
$
```

Look what happens when you look up Susan:

```
$ grep Susan phonebook
Susan Goldberg 201-555-7776
Susan Topple 212-555-4932
$
```

There are two Susans in the datafile, hence the two lines of output—but suppose you only wanted Susan Goldberg’s information. One way to overcome this problem would be to further qualify the name. For example, you could specify the last name as well:

```
$ grep Susan Goldberg phonebook
grep: can't open Goldberg
Susan Goldberg 201-555-7776
Susan Topple 212-555-4932
$
```

But that’s not going to work, as you can see.

Why? Because the shell uses whitespace characters to separate the command arguments, the preceding command line results in `grep` being passed three arguments: `Susan`, `Goldberg`, and `phonebook` (see Figure 5.1).

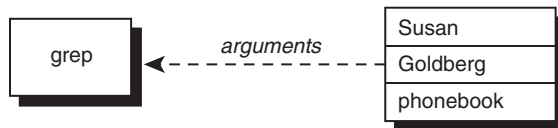

Figure 5.1 `grep Susan Goldberg phonebook`

When `grep` is executed, it interprets the first argument as the search pattern and the remaining arguments as the names of the files to search. In this case, `grep` thinks it’s supposed to look for `Susan` in the files `Goldberg` and `phonebook`. It tries to open the file `Goldberg`, can’t find it, and issues the error message:

```
grep: can't open Goldberg
```

Then it goes to the next file, `phonebook`, opens it, searches for the pattern `Susan`, and prints the two matching lines. Quite logical, really.

The problem is really about how to pass arguments that include whitespace characters to programs.

The solution: enclose the entire argument inside a pair of single quotes, as in

```
grep 'Susan Goldberg' phonebook
```

When the shell sees the first single quote, *it ignores any special characters that follow until it sees the matching closing quote.*

```
$ grep 'Susan Goldberg' phonebook
Susan Goldberg 201-555-7776
$
```

As soon as the shell encountered the first `'` it stopped interpreting any special characters until it found the closing `'`. So the space between `Susan` and `Goldberg`, which would have normally delimited two separate arguments, was ignored by the shell. The shell then split the command line into *two* arguments, the first `Susan Goldberg` (which includes the space character) and the second `phonebook`. It then invoked `grep`, passing it these two arguments (see Figure 5.2).

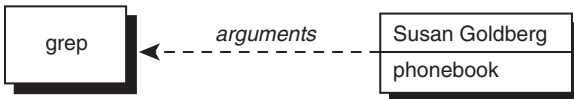

Figure 5.2 `grep 'Susan Goldberg' phonebook`

`grep` interpreted the first argument, `Susan Goldberg`, as a pattern that included an embedded space and looked for it in the file specified by the second argument, `phonebook`. Note that the shell *removes* the quotes and does not pass them to the program.

No matter how many space characters are enclosed between quotes, they are all preserved by the shell.

```
$ echo one           two      three   four
one two three four
$ echo 'one         two      three   four'
one         two      three   four
$
```

In the first case, the shell removes the extra whitespace characters from the line (no quotes!) and passes `echo` the four arguments `one`, `two`, `three`, and `four` (see Figure 5.3).

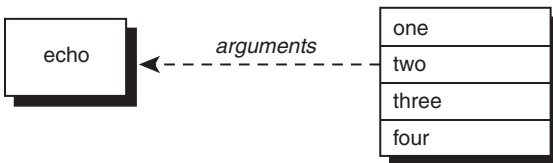

Figure 5.3 `echo one two three four`

In the second case, the extra spaces are preserved and the shell treats the entire string of characters enclosed in quotes as a single argument when executing `echo` (see Figure 5.4).

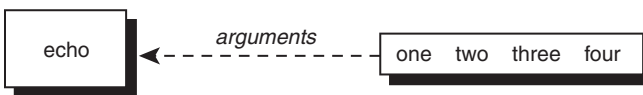

Figure 5.4 `echo 'one two three four'`

Worth emphasizing is that *all* special characters are ignored by the shell if they appear within single quotes. That explains how the following works:

```
$ file=/users/steve/bin/progl
$ echo $file
/users/steve/bin/progl
$ echo '$file'           $ not interpreted
$file
$ echo *
addresses intro lotsaspaces names nu numbers phonebook stat
$ echo '*'
*
$ echo '< > | ; ( ) { } >> " &'
< > | ; ( ) { } >> " &
$
```

Even the Enter key will be retained as part of the command argument if it's enclosed in single quotes:

```
$ echo 'How are you today,
> John'
How are you today,
John
$
```

After parsing the first line, the shell sees that the quote isn't matched, so it prompts the user (with >) to type in the closing quote. The > is known as the *secondary* prompt character and is displayed by the shell whenever it's waiting for you to finish typing a multi-line command.

Quotes are also needed when assigning values containing whitespace or special characters to shell variables, though there are nuances, as demonstrated:

```
$ message='I must say, this sure is fun'
$ echo $message
I must say, this sure is fun
$ text='* means all files in the directory'
$ echo $text
names nu numbers phonebook stat means all files in the directory
$
```

The quotes are needed in the first statement because the value being stored includes spaces.

The second sequence with the variable `text` highlights that the shell does filename substitution after variable name substitution, meaning that the `*` is replaced by the names of all the files in the current directory after the variable is expanded, but before the `echo` is executed. Annoying!

How do you fix these sort of problems? Through the use of double quotes.

The Double Quote

Double quotes work similarly to single quotes, except they're less protective of their content: single quotes tell the shell to ignore *all* enclosed characters, double quotes say to ignore *most*. In particular, the following three characters are not ignored inside double quotes:

- Dollar signs
- Back quotes
- Backslashes

The fact that dollar signs are not ignored means that variable name substitution is done by the shell inside double quotes.

```
$ filelist=*
$ echo $filelist
addresses intro lotsaspaces names nu numbers phonebook stat
$ echo '$filelist'
$filelist
$ echo "$filelist"
*
$
```

Here you see the major difference between no quotes, single quotes, and double quotes. In the first instance, the shell sees the asterisk and substitutes all the filenames from the current directory. In the second case, the shell leaves the characters enclosed within the single quotes completely alone, which results in the display of `$filelist`. In the final case, the double quotes indicate to the shell that variable name substitution is still to be performed inside the quotes. So the shell substitutes `*` for `$filelist`. But because filename substitution is *not* done inside double quotes, `*` is then safely passed to `echo` as the value to be displayed.

Note

While we're talking about single versus double quotes, you should also be aware that the shell has no idea what "smart quotes" are. Those are generated by word processors like Microsoft Word and curl "inward" towards the material they surround, making it much more attractive when printed. The problem is, that'll break your shell scripts, so be alert!

If you want to have the value of a variable substituted, but don't want the shell to then parse the substituted characters specially, enclose the variable inside double quotes.

Here's another example illustrating the difference between double quotes and no quotes:

```
$ address="39 East 12th Street
> New York, N. Y. 10003"
$ echo $address
39 East 12th Street New York, N. Y. 10003
$ echo "$address"
39 East 12th Street
New York, N. Y. 10003
$
```

Note that in this particular example, it makes no difference whether the value assigned to `address` is enclosed in single quotes or double quotes. The shell displays the secondary command prompt in either case to indicate it's waiting for the corresponding close quote.

After assigning the two-line address to `address`, the value of the variable is displayed by `echo`. Without the variable being quoted the address is displayed on a single line. The reason is the same as what caused

```
echo one          two      three  four
```

to be displayed as

```
one two three four
```

Because the shell removes spaces, tabs, and newlines (whitespace characters) from the command line and then cuts it up into arguments before giving it to the requested command, the invocation

```
echo $address
```

causes the shell to remove the embedded newline character, treating it as it would a space or tab: as an argument delimiter. Then the shell passes the *nine* arguments to `echo` for display. `echo` never sees that newline; the shell gets to it first (see Figure 5.5).

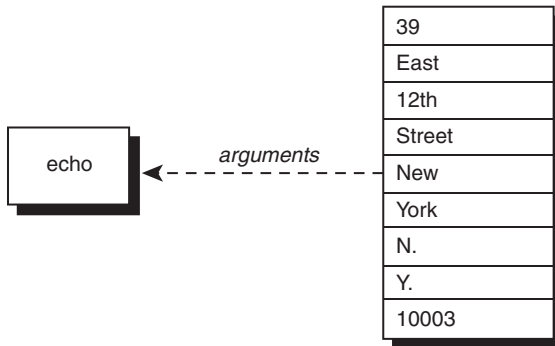

Figure 5.5 `echo $address`

When the command

```
echo "$address"
```

is used instead, the shell substitutes the value of `address` as before, except that the double quotes tell it to leave any embedded whitespace characters alone. So in this case, the shell passes a single argument to `echo`—an argument that contains an embedded newline. `echo` then displays its single argument. Figure 5.6 illustrates this, with the newline character depicted by the sequence `\n`.

Figure 5.6 `echo "$address"`

Where this gets a bit weird is that double quotes can be used to hide single quotes from the shell, and vice versa:

```
$ x="' Hello,' he said"
$ echo $x
'Hello,' he said
$ article=' "Keeping the Logins from Lagging," Bell Labs Record'
$ echo $article
"Keeping the Logins from Lagging," Bell Labs Record
$
```

The Backslash

Functionally, the backslash (used as a prefix) is equivalent to placing single quotes around a single character, though with a few minor exceptions. The backslash *escapes* the character that immediately follows it. The general format is

```
\c
```

where *c* is the character you want to quote. Any special meaning normally attached to that character is removed. Here is an example:

```
$ echo >
syntax error: 'newline or ;' unexpected
$ echo \>
>
$
```

In the first usage, the shell sees the `>` and thinks that you want to redirect `echo`'s output to a file, so it expects a filename to follow. Because it doesn't, the shell issues the error message.

In the next usage, the backslash escapes the special meaning of the `>`, so it is passed along to `echo` as a character to be displayed.

```
$ x=*
$ echo \$x
$x
$
```

In this case, the shell ignores the `$` that follows the backslash, and as a result, variable substitution is not performed.

Because a backslash removes the special meaning of the character that follows, can you guess what happens if that character is another backslash? It removes the special meaning of the backslash:

```
$ echo \  
\  
$
```

You could have also used single quotes to accomplish this task:

```
$ echo '\'  
\  
$
```

Using the Backslash for Continuing Lines

As mentioned at the start of this section, `\c` is essentially equivalent to `'c'`. The one exception to this rule is when the backslash is used as the very last character on the line:

```
$ lines=one'  
> 'two  
$ echo "$lines"  
one  
two  
$ lines=one\  
> two  
$ echo "$lines"  
onetwo  
$
```

Single quotes tell shell to ignore newline

Try it with a \ instead

When a backslash is the last character of a line of input, the shell treats it as a line continuation character. It *removes* the newline character that follows and also does not treat the newline as an argument delimiter (it's as if it wasn't even typed). This construct is often used for entering long commands across multiple lines.

For example, the following is completely valid:

```
Longinput="The shell treats a backslash that's the \  
last character of a line of input as a line \  
continuation. It removes the newline too."
```

The Backslash Inside Double Quotes

We noted earlier that the backslash is one of the three characters interpreted by the shell inside double quotes. This means that you can use the backslash inside these quotes to remove the meaning of characters that otherwise *would* be interpreted inside double quotes (that is, other backslashes, dollar signs, back quotes, newlines, and other double quotes). If the backslash

precedes any other character inside double quotes, the backslash is ignored by the shell and passed on to the program:

```
$ echo "\$x"
$x
$ echo "\ is the backslash character"
\ is the backslash character
$ x=5
$ echo "The value of x is \"$x\""
The value of x is "5"
$
```

In the first example, the backslash precedes the dollar sign so the shell ignores the dollar sign, removes the backslash, and hands the result to `echo`. In the second example, the backslash precedes a space, *not* interpreted by the shell inside double quotes. So the shell ignores the backslash and passes it on to the `echo` command. The last example shows the backslash used to enclose double quotes inside a double-quoted string.

As an exercise in the use of quotes, let's say that you want to display the following line at the terminal:

```
<<< echo $x >>> displays the value of x, which is $x
```

The intention here is to substitute the value of `x` in the second instance of `$x`, but not in the first. Let's first assign a value to `x`:

```
$ x=1
$
```

Now try displaying the line without using any quotes:

```
$ echo <<< echo $x >>> displays the value of x, which is $x
syntax error: '<' unexpected
$
```

The `<` signals input redirection to the shell, which lacks a subsequent filename, hence the resultant error message.

If you put the entire message inside single quotes, the value of `x` won't be substituted at the end. If you enclose the entire string in double quotes, both occurrences of `$x` will be substituted. Tricky!

Here are two different ways to properly quote the string so that everything works as desired:

```
$ echo "<<< echo \$x >>> displays the value of x, which is $x"
<<< echo $x >>> displays the value of x, which is 1
$ echo '<<< echo $x >>> displays the value of x, which is' $x
<<< echo $x >>> displays the value of x, which is 1
$
```

In the first case, everything is enclosed in double quotes, and the backslash is used to prevent the shell from performing variable substitution in the first instance of `$x`. In the second case, everything up to the last `$x` is enclosed in single quotes but the variable that *should* be substituted is added without quotes around it.

There's a slight danger to the latter solution, however: If the variable `x` contained filename substitution or whitespace characters, they would be interpreted. A safer way of writing the `echo` would have been

```
echo '<<< echo $x >>>' displays the value of x, which is '$x'
```

Command Substitution

Command substitution refers to the shell's capability to replace a specified command with the output of that command at any point in a command line. There are two ways in the shell to perform command substitution: by enclosing the command in back quotes or surrounding it with the `$(...)` construct.

The Back Quote

The back quote—often called “back tick”—is unlike any of the previously encountered types of quotes because its purpose is not to protect characters from the shell but to tell the shell to replace the enclosed command with its output. The general format for using back quotes is

```
`command`
```

where *command* is the name of the command to be executed and whose output is to be inserted at that point.

Note

Using the back quote for command substitution is no longer the preferred method; however, we cover it here because of the large number of older shell scripts that still use this construct. You should also know about back quotes in case you ever need to write shell programs that are portable to older Unix systems with shells that don't support the newer, preferred `$(...)` construct.

Here is an example:

```
$ echo The date and time is: `date`
The date and time is: Wed Aug 28 14:28:43 EDT 2002
$
```

When the shell does its initial scan of the command line, it recognizes the back quote and expects a command to follow. In this case, the shell finds the `date` command so it executes `date` and replaces the ``date`` sequence on the command line with the output from `date`. After that, the shell divides the resultant command line into arguments in the normal manner and then hands them all off to the `echo` command.

```
$ echo Your current working directory is `pwd`
Your current working directory is /users/steve/shell/ch6
$
```

Here the shell executes `pwd`, inserts its output on the command line, and then executes the `echo`. Note that in the following section, back quotes can be used in all the places where the `$(...)` construct is used and, of course, vice-versa with the examples in this section.

The `$(...)` Construct

All modern Unix, Linux and any other POSIX-compliant shells support the newer and preferred `$(...)` construct for command substitution. The general format is

```
$(command)
```

where, just as with back quotes, *command* is the name of the command whose standard output is to be substituted on the command line. For example:

```
$ echo The date and time is: $(date)
The date and time is: Wed Aug 28 14:28:43 EDT 2002
$
```

This construct is better than back quotes for a couple of reasons. First, complex commands that use combinations of forward and back quotes can be difficult to read, particularly if the typeface you're using doesn't visually differentiate between single and back quotes; second, `$(...)` constructs can be easily nested, allowing command substitution *within* command substitution. Although nesting can also be performed with back quotes, it's trickier. You'll see an example of nested command substitution later in this section.

Let's emphasize something important: you aren't restricted to invoking a single command between the parentheses. Several commands can be executed if separated by semicolons; and, more commonly, you can also use command pipelines.

Here's a modified version of the `nu` program that displays the number of logged-in users:

```
$ cat nu
echo There are $(who | wc -l) users logged in
$ nu                               Execute it
There are 13 users logged in
$
```

Because single quotes protect everything, the following output should be clear:

```
$ echo '$(who | wc -l) tells how many users are logged in'
$(who | wc -l) tells how many users are logged in
$
```

But command substitution *is* interpreted inside double quotes:

```
$ echo "You have $(ls | wc -l) files in your directory"
You have          7 files in your directory
$
```

Remember that the shell is responsible for executing the command enclosed between the parentheses. The only thing the `echo` command sees is the output that has been inserted by the shell.

Note

Those leading spaces produced by the `wc` command in the above example are a constant source of annoyance for programmers. Can you think of a way to use `sed` to remove them?

Suppose that you're writing a shell program and want to assign the current date and time to a variable called `now`.

Command substitution can be used for this:

```
$ now=$(date)           Execute date and store the output in now
$ echo $now             See what got assigned
Wed Aug 28 14:47:26 EDT 2002
$
```

When you enter

```
now=$(date)
```

the shell understands that the entire output from `date` is to be assigned to `now`. Therefore, you don't need to enclose `$(date)` inside double quotes, though it's a common practice.

Even commands that produce more than a single line of output can be stored inside a variable:

```
$ filelist=$(ls)
$ echo $filelist
addresses intro lotsaspaces names nu numbers phonebook stat
$
```

What happened here? You end up with a horizontal listing of the files even though the newlines from `ls` were stored inside the `filelist` variable. The newlines got eaten up at display time when the value of `filelist` was substituted by the shell in processing the `echo` command line. Double quotes around the variable will preserve the newlines:

```
$ echo "$filelist"
addresses
intro
lotsaspaces
names
nu
numbers
phonebook
stat
$
```

Moving further into the world of shell scripting, let's see how this works with file redirection. For example, to store the contents of a file into a variable, you can use the handy `cat` command:

```
$ namelist=$(cat names)
$ echo "$namelist"
Charlie
Emanuel
Fred
Lucy
Ralph
Tony
Tony
$
```

If you want to mail the contents of the file `memo` to all the people listed in the `names` file, you can do the following:

```
$ mail $(cat names) < memo
$
```

Here the shell replaces the `cat` command with its output on the command line, so it looks like this:

```
mail Charlie Emanuel Fred Lucy Ralph Tony Tony < memo
```

Then the shell executes `mail`, redirecting its standard input from the file `memo` and passing it to the seven recipients specified.

Notice that `Tony` might receive the same mail twice because he's listed twice in the `names` file. You can remove any duplicate entries from the file by using `sort` with the `-u` option (remove duplicate lines) rather than `cat` to ensure that each person only receives mail once:

```
$ mail $(sort -u names) < memo
$
```

Remember that the shell does filename substitution *after* it substitutes the output from commands. Enclosing the commands inside double quotes prevents the shell from doing the filename substitution on the output.

Command substitution is often used to change the value stored in a shell variable. For example, if the shell variable `name` contains someone's name, and you want to convert every character in that variable to uppercase, you could use `echo` to send the variable to `tr`'s input, perform the translation, and then assign the result back to the variable:

```
$ name="Ralph Kramden"
$ name=$(echo $name | tr '[:a-z:]' '[:A-Z:]')           Translate to uppercase
$ echo $name
RALPH KRAMDEN
$
```

The technique of using `echo` in a pipeline to write data to the standard input of the subsequent command is simple but powerful, and is often used in shell programs.

The next example shows how `cut` can be used to extract the first character from the values stored in a variable called `filename`:

```
$ filename=/users/steve/memos
$ firstchar=$(echo $filename | cut -c1)
$ echo $firstchar
/
$
```

`sed` is also often used to “edit” the value stored in a variable. Here it is used to extract the last character from each line of the file specified by the variable `file`:

```
$ file=exec.o
$ lastchar=$(echo $file | sed 's/.*\(.\)$/\1/')
$ echo $lastchar
o
$
```

The `sed` command replaces all the characters on the line with the last one (remember that surrounding a pattern in parentheses causes it to be saved in a register[e] in this case register 1, which is then referenced as `\1`). The result of the `sed` substitution is stored in the variable `lastchar`. The single quotes around the `sed` command are important because they prevent the shell from trying to interpret the backslashes. (Question: would double quotes also have worked?)

Finally, command substitutions can be nested. Suppose that you want to change every occurrence of the first character in a variable to something else. In a previous example, `firstchar=$(echo $filename | cut -c1)` gets the first character from `filename`, but how would we use this character to change every occurrence of that character in `filename`? A two-step process is one way:

```
$ filename=/users/steve/memos
$ firstchar=$(echo $filename | cut -c1)
$ filename=$(echo $filename | tr "$firstchar" "^")    translate / to ^
$ echo $filename
^users^steve^memos
$
```

But a single, nested command substitution can perform the same operation:

```
$ filename=/users/steve/memos
$ filename=$(echo $filename | tr "$(echo $filename | cut -c1)" "^")
$ echo $filename
^users^steve^memos
$
```

If you have trouble understanding this example, compare it to the previous one: Note how the `firstchar` variable in the earlier example is replaced by the nested command substitution; otherwise, the two examples are the same.

The `expr` Command

Although the standard shell supports built-in integer arithmetic, older shells don't have this capability. In that situation, the mathematical equation solver `expr` can be used instead:

```
$ expr 1 + 2
3
$
```

It's easy to work with, but `expr` isn't very good at parsing equations, so each operator and operand given to `expr` must be separated by spaces to be properly understood. That explains the following:

```
$ expr 1+2
1+2
$
```

The usual arithmetic operators are recognized by `expr`: `+` for addition, `-` for subtraction, `/` for division, `*` for multiplication, and `%` for modulus (remainder).

```
$ expr 10 + 20 / 2
20
$
```

Multiplication, division, and modulus have higher precedence than addition and subtraction, as with standard mathematics. Thus, in the preceding example the division was performed before the addition.

But what about this example?

```
$ expr 17 * 6
expr: syntax error
$
```

The shell saw the `*` and substituted the names of all the files in your directory, which `expr` had no idea how to interpret! In the case of multiplication especially, the expression given to `expr` must be quoted to keep it away from the shell's interference—but not as a single argument, as in this example:

```
$ expr "17 * 6"
17 * 6
$
```

Remember that `expr` must see each operator and operand as a separate argument; the preceding example sends the whole expression in as a single argument, which doesn't give you the results you want.

This is a job for the backslash!

```
$ expr 17 \* 6
102
$
```

Naturally, one or more of the arguments to `expr` can be the value stored inside a shell variable because the shell takes care of the substitution first anyway:

```
$ i=1
$ expr $i + 1
2
$
```

This is the older method for performing arithmetic on shell variables and is less efficient than the shell built-in `$ (...)` construct. In the case of incrementing or otherwise modifying a variable, you can use the command substitution mechanism to assign the output from `expr` back to the variable:

```
$ i=1
$ i=$(expr $i + 1)          Add 1 to i
$ echo $i
2
$
```

In legacy shell programs, you're more likely to see `expr` used with the back quotes discussed earlier:

```
$ i=`expr $i + 1`          Add 1 to i
$ echo $i
3
$
```

Similar to the shell's built-in arithmetic, `expr` only evaluates integer arithmetic expressions. You can use `awk` or `bc` if you need to do floating point calculations. The difference? 17 is an integer, while 13.747 is a floating point (that is, number with a decimal point) value.

Also note that `expr` has other operators. One of the most frequently used is the `:` operator, which is used to match characters in the first operand against a regular expression given as the second operand. By default, it returns the number of characters matched.

For example, the `expr` command

```
expr "$file" : ".*"
```

returns the number of characters stored in the variable `file`, because the regular expression `.*` matches all the characters in the string. For more details on `expr` and the powerful colon construct, consult your *Unix User's Manual* or the man page for `expr` on your system.

Table A.5 in Appendix A summarizes the way quotes are handled by the shell.

Passing Arguments

Shell programs become far more useful after you learn how to process arguments passed to them. In this chapter, you'll learn how to write shell programs that take arguments typed on the command line. Recall the one-line program `run` that you wrote in Chapter 4 to run the file `sys.caps` through `tbl`, `nroff`, and `lp`:

```
$ cat run
tbl sys.caps | nroff -mm -Tlp | lp
$
```

Suppose that you need to run other files besides `sys.caps` through this same command sequence. You could make a separate version of `run` for each such file; or, you could modify the `run` program so that you could specify the name of the file to be run on the command line. That is, you could change `run` so that you could type

```
run new.hire
```

for example, to specify that the file `new.hire` is to be printed through this command sequence, or

```
run sys.caps
```

to specify the file `sys.caps`.

Whenever you execute a shell program, the shell automatically stores the first argument in the special shell variable `1`, the second argument in the variable `2`, and so on. (For convenience's sake, from now on we'll refer to these as `$1`, `$2`, and so on, even though the `$` is actually part of the variable reference notation, not the variable name.) These special variables—more formally known as *positional parameters* because they're based on the position of the value in the command line—are assigned after the shell has done its normal command-line processing (that is, I/O redirection, variable substitution, filename substitution, and so on).

To modify the `run` program to accept the name of the file as an argument, all you do to the program is change the reference to the file `sys.caps` so that it instead references the first argument typed on the command line:

```
$ cat run
tbl $1 | nroff -mm -Tlp | lp
$
```

```
$ run new.hire Execute it with new.hire as the argument
request id is laser1-24 (standard input)
$
```

Each time you execute the `run` program, whatever word follows on the command line will be stored inside the first positional parameter by the shell and then handed to the program itself. In the first example, `new.hire` will be stored in this parameter.

Substitution of positional parameters is identical to substitution of other types of variables, so when the shell sees

```
tbl $1
```

it replaces the `$1` with the first argument supplied to the program: `new.hire`.

As another example, the following program, called `ison`, lets you know if a specified user is logged on:

```
$ cat ison
who | grep $1
$ who See who's on
root    console Jul 7 08:37
barney  tty03  Jul 8 12:28
fred    tty04  Jul 8 13:40
joanne  tty07  Jul 8 09:35
tony    tty19  Jul 8 08:30
lulu    tty23  Jul 8 09:55
$ ison tony
tony    tty19  Jul 8 08:30
$ ison pat
$ Not logged on
```

The \$# Variable

In addition to the positional variables, the special shell variable `$#` gets set to the number of arguments that were typed on the command line. As you'll see in the next chapter, this variable is often tested by programs to determine whether the correct number of arguments was specified by the user.

The next program, called `args`, was written just to get you more familiar with the way arguments are passed to shell programs. Study the output from each example and make sure that you understand it:

```
$ cat args Look at the program
echo $# arguments passed
echo arg 1 = :$1: arg 2 = :$2: arg 3 = :$3:
$ args a b c Execute it
3 arguments passed
arg 1 = :a: arg 2 = :b: arg 3 = :c:
$ args a b Try it with two arguments
```

```

2 arguments passed
arg 1 = :a: arg 2 = :b: arg 3 = ::          Unassigned args are null
$ args                                     Try it with no arguments
0 arguments passed
arg 1 =:: arg 2 =:: arg 3 = ::
$ args "a b c"                             Try quotes
1 arguments passed
arg 1 = :a b c: arg 2 = :: arg 3 = ::
$ ls x*                                     See what files start with x
xact
xtra
$ args x*                                   Try filename substitution
2 arguments passed
arg 1 = :xact: arg 2 = :xtra: arg 3 = ::
$ my_bin=/users/steve/bin
$ args $my_bin                             And variable substitution
1 arguments passed
arg 1 = :/users/steve/bin: arg 2 = :: arg 3 = ::
$ args $(cat names)                       Pass the contents of names
7 arguments passed
arg 1 = :Charlie: arg 2 = :Emanuel: arg3 = :Fred:
$

```

As you can see, the shell does its normal command-line processing even when it's executing your shell programs. This means that you can take advantage of the normal niceties, such as filename substitution and variable substitution, when specifying arguments to your programs.

The \$* Variable

The special variable \$* references *all* the arguments passed to the program. This is often useful in programs that take an indeterminate or *variable* number of arguments. You'll see some more practical examples later. Here's a program that illustrates its use:

```

$ cat args2
echo $# arguments passed
echo they are :$:
$ args2 a b c
3 arguments passed
they are :a b c:
$ args2 one                two
2 arguments passed
they are :one two:
$ args2
0 arguments passed
they are ::
$ args2 *
8 arguments passed
they are :args args2 names nu phonebook stat xact xtra:
$

```

A Program to Look Up Someone in the Phone Book

Here's the phonebook file from previous examples:

```
$ cat phonebook
Alice Chebba 973-555-2015
Barbara Swingle 201-555-9257
Liz Stachiw 212-555-2298
Susan Goldberg 201-555-7776
Susan Topple 212-555-4932
Tony Iannino 973-555-1295
$
```

You know how to look up someone in the file by using `grep`:

```
$ grep Cheb phonebook
Alice Chebba 973-555-2015
$
```

And you know that if you want to look up someone by their full name, you need to put quotes around the words to keep the argument together:

```
$ grep "Susan T" phonebook
Susan Topple 212-555-4932
$
```

It would be nice to write a shell program that you could use to look up someone. Let's call the program `lu` and have it take as its argument the name of the person to seek:

```
$ cat lu
#
# Look someone up in the phone book
#

grep $1 phonebook
$
```

Here's a sample use of `lu`:

```
$ lu Alice
Alice Chebba 973-555-2015
$ lu Susan
Susan Goldberg 201-555-7776
Susan Topple 212-555-4932
$ lu "Susan T"
grep: can't open T
phonebook:Susan Goldberg 201-555-7776
phonebook:Susan Topple 212-555-4932
$
```

In the preceding example, you were careful to enclose `Susan T` in double quotes; so what happened? Look again at the `grep` invocation in the `lu` program:

```
grep $1 phonebook
```



```
$ cat phonebook                                     See what happened
Alice Chebba    973-555-2015
Barbara Swingle 201-555-9257
Liz Stachiw     212-555-2298
Susan Goldberg  201-555-7776
Susan Topple    212-555-4932
Tony Iannino    973-555-1295
Stromboli Pizza 973-555-9478
$
```

Stromboli Pizza was quoted so that the shell passed it along to add as a single argument (what would have happened if it wasn't quoted?). After add finished executing, lu was run to see whether it could find the new entry, and it did. The cat command was executed to see what the modified phonebook file looked like. The new entry was added to the end, as intended.

Unfortunately, the new file is no longer sorted. This won't affect the operation of the lu program but it's a nice feature nonetheless. The solution? Add sorting to the program by using the sort command:

```
$ cat add
#
# Add someone to the phonebook file -- version 2
#

echo "$1      $2" >> phonebook
sort -o phonebook phonebook
$
```

Recall that the -o option to sort specifies where the sorted output is to be written, and that this can be the same as the input file:

```
$ add 'Billy Bach' 201-555-7618
$ cat phonebook
Alice Chebba    973-555-2015
Barbara Swingle 201-555-9257
Billy Bach      201-555-7618
Liz Stachiw     212-555-2298
Stromboli Pizza 973-555-9478
Susan Goldberg  201-555-7776
Susan Topple    212-555-4932
Tony Iannino    973-555-1295
$
```

Each time a new entry is added, the phonebook file will get re-sorted so that multi-line matches are always in alphabetical order.

A Program to Remove Someone from the Phone Book

No set of programs that enable you to look up or add someone to the phone book would be complete without a program to remove someone from the phone book too. We'll call this program `rem` and let the user specify the name of the person to be removed as a command argument.

What should the strategy be for developing the program? Essentially, you want to remove the line from the file that contains the specified name, which is a reverse pattern match. The `-v` option to `grep` can be used here because it does exactly what we want, printing all lines from a file that *don't* match a pattern:

```
$ cat rem
#
# Remove someone from the phone book
#

grep -v "$1" phonebook > /tmp/phonebook
mv /tmp/phonebook phonebook
$
```

The `grep` construct writes all lines that don't match into the file `/tmp/phonebook`. (Tip: `/tmp` is a directory designated in Unix systems for temporary files and is usually wiped clean every time the system restarts.) After the `grep` command is done, the old `phonebook` file is replaced by the new one from `/tmp`.

```
$ rem 'Stromboli Pizza'           Remove this entry
$ cat phonebook
Alice Chebba 973-555-2015
Barbara Swingle 201-555-9257
Billy Bach 201-555-7618
Liz Stachiw 212-555-2298
Susan Goldberg 201-555-7776
Susan Topple 212-555-4932
Tony Iannino 973-555-1295
$ rem Susan
$ cat phonebook
Alice Chebba 973-555-2015
Barbara Swingle 201-555-9257
Billy Bach 201-555-7618
Liz Stachiw 212-555-2298
Tony Iannino 973-555-1295
$
```

The first case, where `Stromboli Pizza` was removed, worked fine. In the second case, however, both `Susan` entries were removed because they both matched the pattern. Not good! You can use the `add` program to add them back to the phone book:

```
$ add 'Susan Goldberg' 201-555-7776
$ add 'Susan Topple' 212-555-4932
$
```

In Chapter 7, you'll learn how to test the action prior to taking it so the program can determine whether more than one matching entry is found. The program might want to alert the user that more than one match has been found, for example, rather than just blindly delete multiple entries. (This can be very helpful, because most implementations of `grep` will match *everything* if an empty string is passed as the pattern, which would effectively delete the phonebook entirely. Not good.)

Incidentally, note that `sed` could have also been used to delete the matching entry. In such a case, the `grep` could be replaced with

```
sed "/$1/d" phonebook > /tmp/phonebook
```

to achieve the same result. The double quotes are needed around the `sed` command's argument to ensure that the value of `$1` is substituted, while at the same time ensuring that the shell doesn't see a command line like

```
sed /Stromboli Pizza/d phonebook > /tmp/phonebook
```

and pass three arguments to `sed` rather than two.

`\${n}`

If you supply more than nine arguments to a program, you cannot access the tenth and greater arguments with `$10`, `$11`, and so on. If you try to access the tenth argument by writing

```
$10
```

the shell actually substitutes the value of `$1` followed by a 0. Instead, the format

```
${n}
```

must be used. To directly access argument 10, you must write

```
${10}
```

in your program, and so on for arguments 11, 12, and so on.

The `shift` Command

The `shift` command allows you to effectively *left-shift* your positional parameters. If you execute the command

```
shift
```

whatever was previously stored inside `$2` will be assigned to `$1`, whatever was previously stored in `$3` will be assigned to `$2`, and so on. The old value of `$1` will be irretrievably lost.

When this command is executed, `$#` (the number of arguments variable) is also automatically decremented by one:

```
$ cat tshift
echo $# $*
shift
echo $# $*
```

Program to test the shift

```

shift
echo $# $*
shift
echo $# $*
shift
echo $# $*
shift
echo $# $*
$ tshift a b c d e
5 a b c d e
4 b c d e
3 c d e
2 d e
1 e
0
$

```

If you try to `shift` when there are no variables to shift (that is, when `$#` already equals zero), you'll get an error message from the shell (the error will vary from one shell to the next):

```
prog: shift: bad number
```

where *prog* is the name of the program that executed the offending `shift`.

You can shift more than one “place” at once by writing a *count* immediately after `shift`, as in

```
shift 3
```

This command has the same effect as performing three separate shifts:

```

shift
shift
shift

```

The `shift` command is useful when processing a variable number of arguments. You'll see it put to use when you learn about loops in Chapter 8. For now, just remember that positional parameters can be moved along the chain by using `shift`.

This page intentionally left blank

Decisions, Decisions

This chapter introduces the conditional statement, a construct that is present in almost every programming language: `if`. It enables you to test a condition and then change the flow of program execution based on the result of the test.

The general format of the `if` command is

```
if commandc
then
    command
    command
    ...
fi
```

where *command_c* is executed and its *exit status* is tested. If the exit status is zero, the commands that follow between `then` and `fi` are executed; otherwise, they're skipped.

Exit Status

To understand how conditional tests work, it's important to know about how Unix works with what's called the *exit status*. Whenever any program completes execution, it returns an exit status code to the shell. This status is a numeric value that indicates whether the program ran successfully or failed. By convention, an exit status of zero indicates that a program succeeded, and non-zero indicates that it failed, with different values indicating different kinds of failures.

Failures can be caused by invalid arguments passed to the program, or by an error condition detected by the program. For example, the `cp` command returns a non-zero (fail) exit status if the copy fails (for example, if it can't find the source file or create the destination file), or if the arguments aren't correctly specified (for example, the wrong number of arguments, or more than two arguments and the last one isn't a directory).

What do we mean by non-zero? Simply, any integer value that isn't 0. Most command man pages list possible exit status values too, so possible error conditions for a file copy command could be 1 for file not found, 2 for file not readable, 3 for destination folder not found, 4 for destination folder not writeable, 5 for general error copying the file and, of course, 0 for success.

In the case of `grep`, an exit status of zero (success) is returned if it finds the specified pattern in at least one of the files specified; a non-zero value is returned if it can't find the pattern or if a different error occurs, like failure to open a specified source file.

In a pipeline, the exit status reflects the last command in the pipe. So in

```
who | grep fred
```

the `grep` exit status is used by the shell as the exit status for the whole pipeline. In this case, an exit status of zero (success) means that `fred` was found in `who`'s output (that is, `fred` was logged on at the time that this command was executed).

The \$? Variable

The shell variable `?` is automatically set by the shell to the exit status of the last command executed. Naturally, you can use `echo` to display its value at the terminal.

```
$ cp phonebook phone2
$ echo $?
0                               Copy "succeeded"
$ cp nosuch backup
cp: cannot access nosuch
$ echo $?
2                               Copy "failed"
                               See who's logged on
$ who
root    console Jul 8 10:06
wilma  tty03   Jul 8 12:36
barney  tty04   Jul 8 14:57
betty   tty15   Jul 8 15:03
$ who | grep barney
barney  tty04   Jul 8 14:57
$ echo $?
0                               Print exit status of last command (grep)
                               grep "succeeded"
$ who | grep fred
$ echo $?
1                               grep "failed"
$ echo $?
0                               Exit status of last echo
$
```

Note that the numeric result of a "failure" for some commands can vary from one version of Unix to the next, but success is always signified by a zero exit status.

Let's write a shell program called `on` that tells us whether a specified user is logged on to the system. The name of the user to check will be passed to the program on the command line. If the user is logged on, we'll print a message to that effect; otherwise we'll say nothing. Here is the program:

```

$ cat on
#
# determine if someone is logged on
#

user="$1"

if who | grep "$user"
then
    echo "$user is logged on"
fi
$

```

This first argument typed on the command line is stored in the shell variable `user`. Then the `if` command executes the pipeline

```
who | grep "$user"
```

and tests the exit status returned by `grep`. If the exit status is zero (success), `grep` found `user` in `who`'s output. In that case, the `echo` command that follows is executed. If the exit status is non-zero (failure), the specified user is not logged on, and the `echo` command is skipped.

The `echo` command is indented from the left margin for aesthetic reasons only. In this case, just a single command is enclosed between the `then` and `fi`. When more commands are included, and when the nesting gets deeper, indentation can have a significant impact on the program's readability. Later examples will help illustrate this point.

Here are some sample uses of `on`:

```

$ who
root    console Jul 8 10:37
barney  tty03    Jul 8 12:38
fred    tty04    Jul 8 13:40
joanne  tty07    Jul 8 09:35
tony    tty19    Jul 8 08:30
lulu    tty23    Jul 8 09:55
$ on tony
tony    tty19    Jul 8 08:30
tony is logged on
$ on steve
$ on ann
joanne  tty07    Jul 8 09:35
ann is logged on
$

```

*We know he's on
Where did this come from?*

*We know he's not on
Try this one*

There are a couple of problems with the program as written, however. When the specified user is logged on, the corresponding line from `who`'s output is also displayed, courtesy of the call to `grep`. This may not be such a bad thing, but the program requirements called for only the informational "logged on" message to be displayed and nothing else.

This extra line is displayed because of the conditional test: not only does `grep` return an exit status in the pipeline

```
who | grep "$user"
```

but it also goes about its normal function of writing any matching lines to standard output, even though we're really not interested in that.

Since we're not interested in seeing the result of the command, just testing the exit code, we can dispose of `grep`'s output by redirecting it to the system's "garbage can," `/dev/null`. This is a special file on the system that anyone can read from (and get an immediate end of file) or write to. When you write to it, the bits vanish, as if it were a massive black hole!

```
who | grep "$user" > /dev/null
```

That'll solve the superfluous output problem.

The second problem with `on` appears when the program is executed with the argument `ann`. Even though `ann` is not logged on, `grep` matches the characters `ann` for the user `joanne`. What we need is a more restrictive pattern, which you learned how to do in Chapter 3 where we talked about regular expressions. Because `who` lists each username in column one of the output, we can anchor the pattern to match the beginning of the line by preceding the pattern with the character `^`:

```
who | grep "^$user" > /dev/null
```

But that's still not enough. Search for a pattern like `bob` and `grep` still matches a line like

```
bobby    tty07   Jul 8 09:35
```

What you need to do is also anchor the pattern on the right too. Realizing that `who` ends each username with one or more spaces, the further modified pattern

```
"^$user "
```

now only matches lines for the specified `user`. Problem two fixed!

Let's try the new and improved version of `on`:

```
$ cat on
#
# determine if someone is logged on -- version 2
#
user="$1"
```

```
if who | grep "^$user " > /dev/null
then
    echo "$user is logged on"
fi
$ who                Who's on now?
root      console Jul 8 10:37
barney    tty03     Jul 8 12:38
fred      tty04     Jul 8 13:40
```

```
joanne tty07 Jul 8 09:35
tony tty19 Jul 8 08:30
lulu tty23 Jul 8 09:55
$ on lulu
lulu is logged on
$ on ann
$
$
```

Try this again
What happens if we don't give any arguments?

If no arguments are specified, `user` will be null. `grep` will then look through `who's` output for lines that start with a blank (why?). It won't find any, and so just a command prompt will be returned. In the next section, you'll see how to test whether the correct number of arguments has been supplied to a program and, if not, take some action.

The test Command

Though the previous example program used a pipeline to test for the `if` statement, a built-in shell command called `test` is much more commonly used for testing one or more conditions. Its general format is

```
test expression
```

where *expression* represents the condition you're testing. `test` evaluates *expression*, and if the result is *true*, it returns an exit status of zero, otherwise the result is *false*, and it returns a nonzero exit status.

String Operators

As an example, the following command returns a zero exit status if the shell variable `name` contains the characters `julio`:

```
test "$name" = julio
```

The `=` operator is used to test whether two values are identical. In this case, we're testing to see whether the *contents* of the shell variable `name` are identical to the characters `julio`. If it is, `test` returns an exit status of zero; nonzero otherwise.

Note that `test` must see all operands (`$name` and `julio`) and operators (`=`) as separate arguments, meaning that they must be delimited by one or more whitespace characters.

Getting back to the `if` command, to echo the message "Would you like to play a game?" if `name` contains the characters `julio`, you would write your `if` command like this:

```
if test "$name" = julio
then
    echo "Would you like to play a game?"
fi
```

When the `if` command gets executed, the command that follows the `if` is executed, and its exit status is evaluated. The `test` command is passed the three arguments `$name` (with its

value substituted, of course), `=`, and `julio`. `test` then evaluates whether the first argument is identical to the third argument and returns a zero exit status if it is and a nonzero exit status if it is not.

The exit status returned by `test` is then tested by the `if` statement. If it's zero, the commands between `then` and `fi` are executed; in this case, the single `echo` command is executed. If the exit status is nonzero, the `echo` command is skipped.

As demonstrated above, it's good programming practice to enclose shell variables that are arguments to `test` inside a pair of *double* quotes (to allow variable substitution). This ensures that `test` sees the argument in the even if its value is null. For example, consider the following example:

```
$ name=                               Set name null
$ test $name = julio
sh: test: argument expected
$
```

Because `name` was null, only two arguments were passed to `test`: `=` and `julio`—because the shell substituted the value of `name` *before* parsing the command line into arguments. In fact, after `$name` was substituted by the shell, it was as if you typed the following:

```
test = julio
```

When `test` executed, it saw only two arguments (see Figure 7.1) and therefore issued the error message.

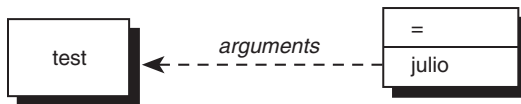

Figure 7.1 `test $name = julio` with `name` null

By placing double quotes around the variable, you ensure that `test` sees the argument because quotes act as a “placeholder” when the argument is null.

```
$ test "$name" = julio
$ echo $?                               Print the exit status
1
$
```

Even if `name` is null, the shell still passes three arguments to `test`, the first one being a null value (see Figure 7.2).

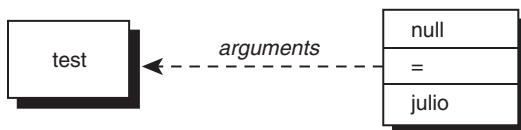

Figure 7.2 `test "$name" = julio` with `name` null

Other operators can be used to test character strings. There are a number of them, as summarized in Table 7.1.

Table 7.1 `test` String Operators

Operator	Returns TRUE (exit status of 0) if
$string_1 = string_2$	$string_1$ is identical to $string_2$
$string_1 != string_2$	$string_1$ is not identical to $string_2$
$string$	$string$ is not null
<code>-n $string$</code>	$string$ is not null (and $string$ must be seen by <code>test</code>)
<code>-z $string$</code>	$string$ is null (and $string$ must be seen by <code>test</code>)

You’ve seen how the `=` operator is used. The `!=` operator is similar, except it tests two strings for inequality. That is, the exit status from `test` is zero if the two strings are not equal, and nonzero if they are.

Let’s look at three similar examples.

```
$ day="monday"
$ test "$day" = monday
$ echo $?
0
True
$
```

The `test` command returns an exit status of 0 because the value of `day` is equal to the characters `monday`. Now look at the following:

```
$ day="monday"
$ test "$day" = monday
$ echo $?
1
False
$
```

Here we assigned the characters `monday`—including the space character that immediately followed—to `day`. Therefore, when the previous test was made, `test` returned FALSE because the characters `"monday"` were not identical to the characters `monday`.

If you wanted these two values to be considered equal, omitting the double quotes around the variable reference would have caused the shell to “eat up” the trailing space character, and `test` would have never seen it:

```
$ day="monday"
$ test $day = monday
$ echo $?
0
True
$
```

Although this seems to violate our rule about always quoting shell variables that are arguments to `test`, it's okay to omit the quotes if you're sure that the variable is not null (and not composed entirely of whitespace characters).

You can test to see whether a shell variable has a null value with the third operator listed in Table 7.1:

```
test "$day"
```

This returns TRUE if `day` is not null and FALSE if it is. Quotes are not necessary here because `test` doesn't care whether it sees an argument in this case. Nevertheless, you are better off using them here as well because if the variable consists entirely of whitespace characters, the shell will get rid of the argument if it's not enclosed in quotes.

```
$ blanks="    "
$ test $blanks           Is it not null?
$ echo $?
1                        False—it's null
$ test "$blanks"        And now?
$ echo $?
0                        True—it's not null
$
```

In the first case, `test` was not passed *any* arguments because the shell ate up the four spaces in `blanks`. In the second case, `test` got one argument consisting of four space characters which is not null.

In case we seem to be belaboring the point about blanks and quotes, realize that this is a frequent source of shell programming errors. It's good to really understand the principles here to save yourself a lot of programming headaches in the future.

There is another way to test whether a string is null, and that's with either of the last two operators listed previously in Table 7.1. The `-n` operator returns an exit status of zero if the argument that follows is not null. Think of this operator as testing for nonzero length.

The `-z` operator tests the argument that follows to see whether it is null and returns an exit status of zero if it is. Think of this operator as testing to see whether the following argument has zero length.

So the command

```
test -n "$day"
```

returns an exit status of 0 if `day` contains at least one character. The command

```
test -z "$dataflag"
```

returns an exit status of 0 if `dataflag` *doesn't* contain any characters. That is, `-n` and `-z` are the opposite of each other, and both exist just to make it easier to write clear, readable conditional statements.

Be warned that both of the preceding operators expect an argument to follow, so get into the habit of enclosing the argument within double quotes.

```
$ nullvar=
$ nonnullvar=abc
$ test -n "$nullvar"           Does nullvar have nonzero length?
$ echo $?
1                               No
$ test -n "$nonnullvar"       And what about nonnullvar?
$ echo $?
0                               Yes
$ test -z "$nullvar"          Does nullvar have zero length?
$ echo $?
0                               Yes
$ test -z "$nonnullvar"       And nonnullvar?
$ echo $?
1                               No
$
```

Note that `test` can also be picky about its arguments. For example, if the shell variable `symbol` contains an equals sign, look at what happens if you try to test it for zero length:

```
$ echo $symbol
=
$ test -z "$symbol"
sh: test: argument expected
$
```

The `=` operator has higher precedence than the `-z` operator, so `test` attempts to process the command as an equality test, and expects an argument to follow the `=`. To avoid this sort of problem, many shell programmers write their `test` commands as

```
test X"$symbol" = X
```

which will be true if `symbol` is null, and false if it's not. The `X` in front of `symbol` prevents `test` from interpreting the characters stored in `symbol` as an operator.

An Alternative Format for `test`

The `test` command is used so often by shell programmers that an alternative format of the command is available and can make your programs a lot neater: `[`. This format improves the readability of `if` statements and other conditional tests throughout your shell scripts.

You'll recall that the general format of the `test` command is

```
test expression
```

This can also be expressed in the alternative format as

```
[ expression ]
```

The `[` is actually the name of the command (who said anything about command names having to be alphanumeric characters?). It still initiates execution of the same `test` command, but when used this way it also expects to see a closing `]` at the end of the expression. Spaces must appear after the `[` and before the `]`.

You can rewrite the `test` command shown in a previous example with this alternative format as shown:

```
$ [ -z "$nonnullvar" ]
$ echo $?
1
$
```

When used in an `if` command, the alternative format looks like this:

```
if [ "$name" = julio ]
then
    echo "Would you like to play a game?"
fi
```

Which format of the `if` command you use is up to you; we prefer the `[...]` format, which coaxes shell programming into a syntax much more similar to other popular programming languages, so that's what we'll use throughout the remainder of the book.

Integer Operators

`test` has a large assortment of operators for performing integer comparisons. Table 7.2 summarizes these operators.

Table 7.2 `test` Integer Operators

Operator	Returns TRUE (exit status of 0) if
int_1 -eq int_2	int_1 is equal to int_2
int_1 -ge int_2	int_1 is greater than or equal to int_2
int_1 -gt int_2	int_1 is greater than int_2
int_1 -le int_2	int_1 is less than or equal to int_2
int_1 -lt int_2	int_1 is less than int_2
int_1 -ne int_2	int_1 is not equal to int_2

For example, the operator `-eq` tests to see whether two integers are equal. So if you had a shell variable called `count` and you wanted to see whether its value was equal to zero, you would write

```
[ "$count" -eq 0 ]
```

Other integer operators behave similarly, so

```
[ "$choice" -lt 5 ]
```

tests to see whether the variable `choice` is less than 5.

The command

```
[ "$index" -ne "$max" ]
```

tests to see whether the value of `index` is not equal to the value of `max`.

Finally

```
[ "$#" -ne 0 ]
```

tests to see whether the number of arguments passed to the command is not equal to zero.

It's important to note that the `test` command, not the shell itself, interprets the variable's value as an integer when an integer operator is used, so these comparisons work regardless of the shell variable's type.

Let's have a closer look at the difference between `test`'s string and integer operators with a few examples.

```
$ x1="005"
$ x2=" 10"
$ [ "$x1" = 5 ]           String comparison
$ echo $?
1                         False
$ [ "$x1" -eq 5 ]       Integer comparison
$ echo $?
0                         True
$ [ "$x2" = 10 ]       String comparison
$ echo $?
1                         False
$ [ "$x2" -eq 10 ]     Integer comparison
$ echo $?
0                         True
$
```

The first test

```
[ "$x1" = 5 ]
```

uses the *string* comparison operator `=` to test whether the two strings are identical. They're not, because the first string is composed of the three characters `005`, and the second the single character `5`.

In the second test, the integer comparison operator `-eq` is used. Treating the two values as integers (numbers), `005` is equal to `5`, as verified by the `test` exit status.

The third and fourth tests are similar, but in these cases you can see how even a leading space stored in the variable `x2` can influence a test made with a string operator versus one made with an integer operator.

File Operators

Virtually every shell program deals with one or more files. For this reason, a wide assortment of operators are provided by `test` to enable you to ask various questions about files. Each of these operators is *unary* in nature, meaning that they expect a single argument to follow. In all cases, the second argument is the name of a file (and that includes a directory name, as appropriate).

Table 7.3 lists the common file operators.

Table 7.3 Commonly Used `test` File Operators

Operator	Returns TRUE (exit status of 0) if
<code>-d file</code>	<i>file</i> is a directory
<code>-e file</code>	<i>file</i> exists
<code>-f file</code>	<i>file</i> is an ordinary file
<code>-r file</code>	<i>file</i> is readable by the process
<code>-s file</code>	<i>file</i> has nonzero length
<code>-w file</code>	<i>file</i> is writable by the process
<code>-x file</code>	<i>file</i> is executable
<code>-L file</code>	<i>file</i> is a symbolic link

The command

```
[ -f /users/steve/phonebook ]
```

tests whether the file `/users/steve/phonebook` exists and is an ordinary file (that is, not a directory or special file).

The command

```
[ -r /users/steve/phonebook ]
```

tests whether the indicated file exists and is also readable by you.

The command

```
[ -s /users/steve/phonebook ]
```

tests whether the indicated file has non-zero content (that is, isn't an empty file). This is useful if you create an error log file and later want to see whether anything was written to it:

```
if [ -s $ERRFILE ]
then
```

```

    echo "Errors found:"
    cat $ERRFILE
fi

```

A few more `test` operators, when combined with the previously described operators, enable you to specify more complicated conditional expressions.

The Logical Negation Operator !

The unary logical negation operator `!` can be placed in front of any other `test` expression to *negate* the result of the evaluation of that expression. For example,

```
[ ! -r /users/steve/phonebook ]
```

returns a zero exit status (true) if `/users/steve/phonebook` is *not* readable; and

```
[ ! -f "$mailfile" ]
```

returns true if the file specified by `$mailfile` does *not* exist or is *not* an ordinary file. Finally,

```
[ ! "$x1" = "$x2" ]
```

returns true if `$x1` is not identical to `$x2` and is obviously equivalent to (and the more confusing cousin of) the clearer conditional expression

```
[ "$x1" != "$x2" ]
```

The Logical AND Operator -a

The operator `-a` performs a logical *AND* of two expressions and returns TRUE only if the two joined expressions are both true. So

```
[ -f "$mailfile" -a -r "$mailfile" ]
```

returns TRUE if the file specified by `$mailfile` is an ordinary file and is readable by you. (An extra space was placed around the `-a` operator to aid in the expression's readability and obviously has no effect on its execution.)

The command

```
[ "$count" -ge 0 -a "$count" -lt 10 ]
```

will be true if the variable `count` contains an integer value greater than or equal to zero but less than 10. The `-a` operator has lower *precedence* than the integer comparison operators (and the string and file operators, for that matter), meaning that the preceding expression gets evaluated as

```
("$count" -ge 0) -a ("$count" -lt 10)
```

as you would expect.

In some cases, it's important to know that `test` immediately stops evaluating an AND expression as soon as something is proven to be false, so a statement like

```
[ ! -f "$file" -a $(who > $file) ]
```

will not run in the subshell with the `who` invocation if the `! -f` (non-existence) test fails, because `test` already knows that the AND (`-a`) expression is false. Subtle, but something that can trip up shell programmers if they try to jam too much into conditional expressions with the assumption that everything is run prior to the conditional tests being applied.

Parentheses

You *can* use parentheses in a `test` expression to alter the order of evaluation as needed; just make sure that the parentheses themselves are quoted because they have a special meaning to the shell. So to translate the earlier example into a `test` command, you would write

```
[ \( "$count" -ge 0 \) -a \( "$count" -lt 10 \) ]
```

As is typical, spaces must surround the parentheses because `test` expects to see every element in the conditional statement as a separate argument.

The Logical OR Operator `-o`

The `-o` operator is similar to the `-a` operator, only it forms a logical *OR* of two expressions. That is, evaluation of the expression will be true if *either* the first expression is true *or* the second expression is true *or* both expressions are true.

```
[ -n "$mailopt" -o -r $HOME/mailfile ]
```

This command will be true if the variable `mailopt` is not null *or* if the file `$HOME/mailfile` is readable by you.

The `-o` operator has lower precedence than the `-a` operator, meaning that the expression

```
"$a" -eq 0 -o "$b" -eq 2 -a "$c" -eq 10
```

gets evaluated by `test` as

```
"$a" -eq 0 -o ("$b" -eq 2 -a "$c" -eq 10)
```

Naturally, you can use parentheses to change this order if necessary:

```
\( "$a" -eq 0 -o "$b" -eq 2 \) -a "$c" -eq 10
```

Since precedence is critically important in complex conditional statements, you'll find that a lot of shell programmers have nested `if` statements to side-step any issues, while others use explicit parentheses to clarify order of interpretation. Certainly just assuming things are interpreted left-to-right is dangerous!

You will see many uses of the `test` command throughout the book because it's almost impossible to write even simple shell programs without some sort of conditional statements involved. Table A.11 in Appendix A summarizes all available `test` operators.

The `else` Construct

A construct known as `else` can be added to the `if` command, with the general format as shown:

```
if commandt
then
    command
    command
    . . .
else
    command
    command
. . .
fi
```

In the above, *command_t* is executed and its exit status evaluated. If it's true (zero), the `then` code block (all the statements between `then` and `else`) is executed and the `else` block is ignored. If the exit status is false (non-zero), the `then` code block is ignored and the `else` code block (everything between `else` and `fi`) is executed. In either case, only one set of commands gets executed: the first set if the exit status is zero, and the second set if it's nonzero.

This can be more succinctly explained:

```
if condition then statements-if-true else statements-if-false fi
```

Let's now write a modified version of `on`. Instead of having no output if the requested user is not logged on, we'll have the program report that fact to the user.

Here is version 3 of the program:

```
$ cat on
#
# determine if someone is logged on -- version 3
#
user="$1"

if who | grep "^$user " > /dev/null
then
    echo "$user is logged on"
else
    echo "$user is not logged on"
fi
$
```

If the user specified as the first argument to `on` is logged on, the `grep` will succeed and the message `user is logged on` will be displayed; otherwise, the message `user is not logged on` will be displayed.

```

$ who                                Who's on?
root      console Jul  8 10:37
barney    tty03    Jul  8 12:38
fred      tty04    Jul  8 13:40
joanne    tty07    Jul  8 09:35
tony      tty19    Jul  8 08:30
lulu      tty23    Jul  8 09:55

$ on pat
pat is not logged on

$ on tony
tony is logged on

$

```

To turn a quick prototype into a useful program for the long term, it's a good practice to make sure that the correct number of arguments is passed to the program. If the user specifies the wrong number of arguments, an appropriate error message can be issued, along with a usage message. Like this:

```

$ cat on
#
# determine if someone is logged on -- version 4
#
#
# see if the correct number of arguments were supplied
#
if [ "$#" -ne 1 ]
then
    echo "Incorrect number of arguments"
    echo "Usage: on user"
else
    user="$1"

    if who | grep "^$user " > /dev/null
    then
        echo "$user is logged on"
    else
        echo "$user is not logged on"
    fi
fi
$

```

It seems like a lot of changes, but other than wrapping all the previous code within an `else-fi` pair, the primary addition is an `if` command to evaluate whether the correct number of arguments was supplied. If `$#` is not equal to `1`, the required number of arguments, the program prints two error messages; otherwise, the commands after the `else` clause are executed. Note that two `fi` commands are required because two `if` commands are used.

As you can see, indentation goes a long way toward making the program easy to read and understand. Get into the habit of setting and following indentation rules in your own programs and you'll definitely thank us later on as your programs become increasingly complicated.

The sophistication of the user experience is clearly improved over previous versions of the program:

```
$ on                                     No arguments
Incorrect number of arguments
Usage:  on user
$ on priscilla                             One argument
priscilla is not logged on
$ on jo anne                               Two arguments
Incorrect number of arguments
Usage:  on user
$
```

The `exit` Command

A built-in shell command called `exit` enables you' to immediately terminate execution of your shell program. The general format of this command is

```
exit n
```

where `n` is the exit status that you want returned. If none is specified, the exit status used is that of the last command executed prior to the `exit` (that is, it's effectively `exit $?`).

Be advised that executing the `exit` command directly from your terminal will log you off the system because it will have the effect of terminating execution of your login shell.

A Second Look at the `rem` Program

`exit` is frequently used as a convenient way to terminate execution of a shell program. For example; let's take another look at the `rem` program, which removes an entry from the `phonebook` file:

```
$ cat rem
#
# Remove someone from the phone book
#

grep -v "$1" phonebook > /tmp/phonebook
mv /tmp/phonebook phonebook
$
```

As written, this program has the potential to create problems if unexpected situations arise, potentially even corrupting or wiping out the entire `phonebook` file.

For example, suppose that you type in

```
rem Susan Topple
```

The shell will pass two arguments to `rem` because of the missing quotes. The `rem` program will then remove all `Susan` entries, as specified by `$1`, without ever seeing that there were too many arguments specified by the user in the first place.

As a result, it's always best to take precautions with any potentially destructive program and to be certain that the action intended by the user is consistent with the action that the program is poised to take.

One of the first checks that can be made in `rem` is for the correct number of arguments, as was done earlier with the `on` program. This time, we'll use the `exit` command to terminate the program if the correct number of arguments isn't supplied:

```
$ cat rem
#
# Remove someone from the phone book -- version 2
#

if [ "$#" -ne 1 ]
then
    echo "Incorrect number of arguments."
    echo "Usage: rem name"
    exit 1
fi
```

```
grep -v "$1" phonebook > /tmp/phonebook
```

```
mv /tmp/phonebook phonebook
```

```
$ rem Susan Goldberg
```

Try it out

```
Incorrect number of arguments.
```

```
Usage: rem name
```

```
$
```

The `exit` command returns an exit status of 1, to signal failure, in case some other program wants to check it in a conditional expression. How could you have written the preceding program with an `if-else` instead of using the `exit`?

Whether you use the `exit` or an `if-else` is up to you. Sometimes the `exit` is a more convenient way to get out of the program quickly, particularly if it's done early in the program, and it has the additional benefit of avoiding the need for deeply nested conditionals.

The `elif` Construct

As your programs become more complex, you may find yourself stuck writing nested `if` statements like this:

```
if command1
then
```

```

    command
    command
    ...
else
    if command2
    then
        command
        command
        ...
    else
        ...
        if commandn
        then
            command
            command
            ...
        else
            command
            command
            ...
        fi
    ...
fi
fi

```

This type of command sequence can be useful when you need to make more than just a two-choice decision. In this case, a multiway decision is made, with the last `else` clause executed if none of the preceding conditions is satisfied.

As a relatively simple example, let's write a program called `greetings` that prints a friendly Good morning, Good afternoon, or Good evening based on time of day. For purposes of the example, consider any time from midnight to noon to be the morning, noon to 6 pm the afternoon, and 6 pm to midnight the evening.

To write this program, you have to find out what time it is. `date` serves just fine for this purpose. Take another look at the output from this command:

```

$ date
Wed Aug 29 10:42:01 EDT 2002
$

```

The format of `date`'s output is fixed, a fact that you can use to your advantage because the time will always appear in character positions 12 through 19. In fact, you really only need the hour value in positions 12 and 13:

```

$ date | cut -c12-13
10
$

```

Now the task of writing the `greetings` program is straightforward:

```
$ cat greetings
#
# Program to print a greeting
#

hour=$(date | cut -c12-13)

if [ "$hour" -ge 0 -a "$hour" -le 11 ]
then
    echo "Good morning"
else
    if [ "$hour" -ge 12 -a "$hour" -le 17 ]
    then
        echo "Good afternoon"
    else
        echo "Good evening"
    fi
fi
$
```

If `hour` is greater than or equal to 0 (midnight) and less than or equal to 11 (up to 11:59:59), `Good morning` is displayed. If `hour` is greater than or equal to 12 (noon) and less than or equal to 17 (up to 5:59:59 pm), `Good afternoon` is displayed. If neither of the preceding conditions is satisfied, `Good evening` is displayed.

```
$ greetings
Good morning
$
```

Look at the program again, however, and you'll realize that the nested `if` command sequence used in `greetings` is rather clumsy. To streamline these sorts of `if-then-else` sequences, the shell also supports a special `elif` element that acts somewhat like `else if condition`, except it doesn't increase your nesting level. The general format is

```
if command1
then
    command
    command
    ...
elif command2
then
    command
    command
    ...
else
    command
    command
    ...
fi
```

`command1`, `command2`, ..., `commandn` are executed in turn and their exit statuses tested. As soon as one returns an exit status of TRUE (zero), the commands listed after the `then` that follows are executed, up to another `elif`, `else`, or `fi`. If none of the conditional expressions is true, the commands listed after the optional `else` are executed.

Now you can rewrite the `greetings` program using this new format as shown:

```
$ cat greetings
#
# Program to print a greeting -- version 2
#

hour=$(date | cut -c12-13)

if [ "$hour" -ge 0 -a "$hour" -le 11 ]
then
    echo "Good morning"
elif [ "$hour" -ge 12 -a "$hour" -le 17 ]
then
    echo "Good afternoon"
else
    echo "Good evening"
fi
$
```

A definite improvement. The program is easier to read, and it doesn't have the tendency to wander off the right margin due to progressively increasing indentation.

Incidentally, it's very rare to see `date | cut` as a pipe because the `date` command itself has a rich and complex set of output formats you can utilize to get just the information or value you want. For example, to output just the current hour in 0–23 format, use `%H` with the necessary `+` prefix to indicate it's a formatting string:

```
$ date +%H
10
$
```

As an exercise, you should change `greetings` to make use of this more streamlined way to identify the current hour of the day.

Yet Another Version of `rem`

Let's jump back to the phone number removal program `rem`. Earlier we mentioned that it was dangerous because without checking the validity of its actions, it could blindly delete more than the user desired.

One way to address this problem is to check the *number* of entries that match the user specified pattern before doing the removal: If there's more than one match, issue a message to that effect and terminate execution of the program. But how do you determine the number of matching entries?

One easy way is to do a `grep` on the `phonebook` file and count the number of resulting matches with `wc`. If the number of matches is greater than one, the appropriate message can be issued. That logic can be coded like this:

```
$ cat rem
#
# Remove someone from the phone book -- version 3
#

if [ "$#" -ne 1 ]
then
    echo "Incorrect number of arguments."
    echo "Usage: rem name"
    exit 1
fi

name=$1

#
# Find number of matching entries
#

matches=$(grep "$name" phonebook | wc -1)

#
# If more than one match, issue message, else remove it
#

if [ "$matches" -gt 1 ]
then
    echo "More than one match; please qualify further"
elif [ "$matches" -eq 1 ]
then
    grep -v "$name" phonebook > /tmp/phonebook
    mv /tmp/phonebook phonebook
else
    echo "I couldn't find $name in the phone book"
fi
$
```

To improve readability, the positional parameter `$1` is assigned to the variable `name` after the number of arguments is checked.

Assigning the output of a command sequence to a variable is very common in shell programs, as demonstrated on the line

```
matches=$(grep "$name" phonebook | wc -1)
```

With `matches` calculated, it's easy to step through the `if...elif...else` command sequence and see that it first tests to see whether the number of matches is greater than one. If it is, the

“more than one match” message is printed. If it’s not, a test is made to see whether the number of matches is equal to one. If it is, the entry is removed from the phone book. If it’s not one or greater than one, the number of matches must be zero, in which case a message is displayed to alert the user to this fact.

Note that the `grep` command is used twice in this program: first to determine the number of matches, then with the `-v` option to remove the matching entry after ensuring that only one line matches.

Here are some sample runs of this version of `rem`:

```
$ rem
Incorrect number of arguments.
Usage: rem name
$ rem Susan
More than one match; please qualify further
$ rem 'Susan Topple'
$ rem 'Susan Topple'
I couldn't find Susan Topple in the phone book    She's history
$
```

Now you have a fairly robust `rem` program: it checks for the correct number of arguments, printing the proper usage if the correct number isn’t supplied; it also checks to make sure that precisely one entry is removed from the `phonebook` file.

In typical Unix fashion, also note that the `rem` script has no output when the requested action succeeds.

The case Command

The `case` command allows you to compare a single value against a set of other values or expressions and to execute one or more commands when a match is found. The general format of this command is

```
case value in
  pattern1)  command
             command
             ...
             command;;
  pattern2)  command
             command
             ...
             command;;
  ...
  patternn)  command
             command
             ...
             command;;
esac
```

The word *value* is successively compared against the values *pattern₁*, *pattern₂*, ..., *pattern_n*, until a match is found. When a match is found, the commands listed after the matching value are executed, up to the double semicolons, which serve as a “break” statement that shows you’ve finished specifying commands for that particular conditional. After the double semicolons are reached, the execution of the *case* is terminated. If a match is not found, none of the commands listed in the *case* is executed.

As an example of the use of the *case* statement, the following program called *number* takes a single digit and translates it to its English equivalent:

```
$ cat number
#
# Translate a digit to English
#

if [ "$#" -ne 1 ]
then
    echo "Usage: number digit"
    exit 1
fi

case "$1"
in
    0) echo zero;;
    1) echo one;;
    2) echo two;;
    3) echo three;;
    4) echo four;;
    5) echo five;;
    6) echo six;;
    7) echo seven;;
    8) echo eight;;
    9) echo nine;;
esac
$
```

Now to test it:

```
$ number 0
zero
$ number 3
three
$ number
Usage: number digit
$ number 17
$
```

Try no arguments

Try a two-digit number

The last case shows what happens when you type in more than one digit: *\$1* doesn’t match any of the values listed in the *case*, so none of the *echo* commands is executed.

Special Pattern-Matching Characters

The `case` statement is quite powerful because instead of just specifying sequences of letters, you can create complex regular expressions in the shell notation. That is, you can use the same special characters for specifying the patterns in a case as you can with filename substitution. For example, `?` can be used to specify any single character; `*` can be used to specify zero or more occurrences of any character; and `[...]` can be used to specify any single character enclosed between the brackets.

Because the pattern `*` matches *anything* (just like how `echo *` matches all files in the current directory), it's frequently used at the end of the `case` as the "catch-all" or default value: if none of the previous values in the case match, this one's guaranteed to be a match.

With that in mind, here's a second version of the `number` program that has such a catch-all case statement.

```
$ cat number
#
# Translate a digit to English -- version 2
#

if [ "$#" -ne 1 ]
then
    echo "Usage: number digit"
    exit 1
fi

case "$1"
in
    0) echo zero;;
    1) echo one;;
    2) echo two;;
    3) echo three;;
    4) echo four;;
    5) echo five;;
    6) echo six;;
    7) echo seven;;
    8) echo eight;;
    9) echo nine;;
    *) echo "Bad argument; please specify a single digit";;
esac
$ number 9
nine
$ number 99
Bad argument; please specify a single digit
$
```

Let's switch to another program, `ctype`, that identifies and prints the class of the single character given as an argument. Character types recognized are digits, uppercase letters,

lowercase letters, and special characters (anything not in the first three categories). As an added check, the program also ensures that only a single character is given as the argument.

```
$ cat ctype
#
# Classify character given as argument
#

if [ $# -ne 1 ]
then
    echo Usage: ctype char
    exit 1
fi

#
# Ensure that only one character was typed
#

char="$1"
numchars=$(echo "$char" | wc -c)

if [ "$numchars" -ne 1 ]
then
    echo Please type a single character
    exit 1
fi

#
# Now classify it
#

case "$char"
in
    [0-9]    ) echo digit;;
    [a-z]    ) echo lowercase letter;;
    [A-Z]    ) echo uppercase letter;;
    *        ) echo special character;;
esac
$
```

But when we try a few sample runs, something's not right:

```
$ ctype a
Please type a single character
$ ctype 7
Please type a single character
$
```

The `-x` Option for Debugging Programs

A bug. Not uncommon at all in the process of developing programs, whether they're 5 lines or 500 lines long. In this instance, it appears that the letter counting portion of our program isn't working properly. But how do you figure out what's not working?

This is a good point to introduce the shell's `-x` option. To debug any shell program—or learn more about how it works—trace the sequence of its execution by typing in `sh -x` followed by the regular invocation (name and arguments). This starts up a new shell to execute the indicated program with the `-x` option enabled.

In this mode, commands are printed at the terminal as they are executed, preceded by a plus sign. Let's try it out!

```
$ sh -x ctype a
+ [ 1 -ne 1 ]
+ char=a
+ echo a
+ wc -c
+ numchars=      2
+ [      2 -ne 1 ]
+ echo please type a single character
please type a single character
+ exit 1
$
```

Trace execution
 \$# equals 1
Assignment of \$1 to char
wc returned 2???
That's why this test succeeded

The trace output indicates that `wc` returned 2 when this command was executed:

```
echo "$char" | wc -c
```

But why the value 2 if the command was given the single letter `a`? It turns out that two characters were actually given to `wc`: the single character `a` and the “invisible” newline character that `echo` automatically prints at the end of each line. Oops. So instead of testing for a single character by comparing it to 1, the conditional expressions should be comparing the user input to 2: the character typed plus the newline added by `echo`.

Go back to the `ctype` program and update the `if` command that reads

```
if [ "$numchars" -ne 1 ]
then
    echo Please type a single character
    exit 1
fi
```

to look like this

```
if [ "$numchars" -ne 2 ]
then
    echo Please type a single character
    exit 1
fi
```

and try it again.

```
$ ctype a
lowercase letter
$ ctype abc
Please type a single character
$ ctype 9
digit
$ ctype K
uppercase letter
$ ctype :
special character
$ ctype
Usage: ctype char
$
```

Now it seems to work just fine.

In Chapter 11 you'll learn how you can turn this trace feature on and off at will from *inside* your program too; but for now, we encourage you to try using `sh -x` on the various scripts we've created so far.

Before leaving the `ctype` program, here's a version that avoids the use of `wc` and handles all possible conditions with `case` statements:

```
$ cat ctype
#
# Classify character given as argument -- version 2
#

if [ $# -ne 1 ]
then
    echo Usage: ctype char
    exit 1
fi

#
# Now classify char, making sure only one was typed
#

char=$1

case "$char"
in
    [0-9] ) echo digit;;
    [a-z] ) echo lowercase letter;;
    [A-Z] ) echo uppercase letter;;
    ?     ) echo special character;;
    *     ) echo Please type a single character;;
esac
$
```

Remember, the `?` matches any single character. Since we already have tested the character against digits, and lowercase and uppercase letters, if this pattern is matched, the character must be a special character. Finally, if this pattern *isn't* matched, more than one character must have been typed, so the catch-all case prints the appropriate error message.

```
$ ctype u
lowercase letter
$ ctype '>'
special character
$ ctype xx
Please type a single character
$
```

Back to the case

The symbol `|` has the effect of a logical OR when used between two patterns. That is, the pattern

```
pat1 | pat2
```

specifies that either *pat*₁ or *pat*₂ is to be matched. For example,

```
-l | -list
```

matches either the value `-l` or `-list`, and

```
dmd | 5620 | tty5620
```

matches any of `dmd` or `5620` or `tty5620`.

Knowing about the `case` statement, there are a number of different programmatic flow structures that can be more neatly and efficiently rewritten as `case` sequences.

For example, the `greetings` program that you saw earlier in this chapter can be rewritten to use a `case` statement rather than the clunkier `if-elif`. This time, let's take advantage of the fact that `date` with the `+%H` option writes a two-digit hour to standard output.

```
$ cat greetings
#
# Program to print a greeting -- case version
#

hour=$(date +%H)

case "$hour"
in
    0? | 1[01] ) echo "Good morning";;
    1[2-7]     ) echo "Good afternoon";;
    *          ) echo "Good evening";;
esac
$
```

The two-digit hour obtained from `date` is assigned to the shell variable `hour`, then the `case` statement is executed. The value of `hour` is compared against the first pattern:

```
0? | 1[01]
```

which matches any value that starts with a zero followed by any character (midnight through 9 am), or any value that starts with a one and is followed by a zero or one (10 or 11 am).

The second pattern

```
1[2-7]
```

matches a value that starts with a one and is followed by any one of the digits two through seven (noon through 5 pm).

The last case, the catch-all, matches anything else (6 pm through 11 pm).

```
$ date
Wed Aug 28 15:45:12 EDT 2002
$ greetings
Good afternoon
$
```

The Null Command :

Every matching `case` statement needs a resulting command, and every `if-then` conditional needs a resultant command too—but sometimes you don't want to execute anything, just “eat” the result. How do you do that? With the shell's built-in `null` command. The format of this command is simply

```
:
```

and the purpose of it is—you guessed it—to do nothing.

In most cases it's used to satisfy the requirement that a command appear, particularly in `if` statements. Suppose that you want to make sure that the value stored in the variable `system` exists in the file `/users/steve/mail/systems`, and if it doesn't, you want to issue an error message and exit from the program. So you start by writing something like

```
if grep "^$system" /users/steve/mail/systems > /dev/null
then
```

but you don't know what to write after the `then` because you want to test for the nonexistence of the `system` in the file and don't want to do anything special if the `grep` succeeds. The shell requires that you write a command after the `then`, so here's where the null command comes to the rescue:

```
if grep "^$system" /users/steve/mail/systems > /dev/null
then
    :
else
    echo "$system is not a valid system"
    exit 1
fi
```

If the conditional test is valid, nothing is done. If it's not valid, the error message is issued and the program exited.

To be fair, this particular example could be reversed by restructuring the `grep` statement (remember the `!` argument to `test`?) but sometimes it's easier to test for a positive condition and do nothing than a negative. In either case, this is where a well placed comment can do wonders when the code is read weeks or months later.

The && and || Constructs

The shell has two special constructs that enable you to execute a command based on whether the preceding command succeeds or fails. In case you think this sounds similar to the `if` command, well it is. Sort of. It's a shorthand form of the `if`.

If you write

```
command1 && command2
```

anywhere that the shell expects to see a command, `command1` will be executed, and if it returns an exit status of zero (success), `command2` will be executed. If `command1` returns a non-zero exit status (fail), `command2` is *not* invoked but is ignored.

For example, if you write

```
sort bigdata > /tmp/sortout && mv /tmp/sortout bigdata
```

then the `mv` command will be executed only if the `sort` is successful. Note that this is equivalent to writing

```
if sort bigdata > /tmp/sortout
then
    mv /tmp/sortout bigdata
fi
```

The command

```
[ -z "$EDITOR" ] && EDITOR=/bin/ed
```

tests the value of the variable `EDITOR`. If it's null, `/bin/ed` is assigned to it.

The `||` construct works similarly, except that the second command gets executed only if the exit status of the first is nonzero. So if you write

```
grep "$name" phonebook || echo "Couldn't find $name"
```

the `echo` command will get executed only if the `grep` fails (that is, if it can't find `$name` in `phonebook`, or if it can't open the file `phonebook`). In this case, the equivalent `if` command would look like

```
if grep "$name" phonebook
then
    :
```

```
else
    echo "Couldn't find $name"
fi
```

You can use a complex sequence of commands on either or both the left- or right-hand side of these constructs. On the left, the exit status tested is that of the last command in the pipeline; thus

```
who | grep "^$name " > /dev/null || echo "$name's not logged on"
```

causes execution of the `echo` if the `grep` fails.

The `&&` and `||` can also be combined on the same command line:

```
who | grep "^$name " > /dev/null && echo "$name's not logged on" \
    || echo "$name is logged on"
```

(Recall that when `\` is used at the end of the line it signals line continuation to the shell.)

The first `echo` gets executed if the `grep` succeeds; the second if it fails.

These constructs are also often used in `if` commands, as demonstrated in this snippet from a system shell program (don't worry if you don't understand every command invoked):

```
if validsys "$sys" && timeok
then
    sendmail "$user@$sys" < $message
fi
```

If `validsys` returns an exit status of zero, `timeok` is executed and its exit status is then tested for the `if`. If that status is zero, then `sendmail` is executed. If `validsys` returns a nonzero exit status, however, `timeok` is not executed, and the failed exit status is then tested by the `if`, and `sendmail` ends up not being executed.

The use of the `&&` operator in the preceding case is a *logical AND*; both programs must return an exit status of zero for the `sendmail` program to be executed. In fact, you could have written the above `if` conditional as

```
validsys "$sys" && timeok && sendmail "$user@$sys" < $message
```

By comparison, when the `||` is used in an `if`, the effect is like a *logical OR*:

```
if endofmonth || specialrequest
then
    sendreports
fi
```

If `endofmonth` returns a zero exit status, `sendreports` is executed; otherwise `specialrequest` is executed and if its exit status is zero, `sendreports` is executed. The net effect is that `sendreports` is executed if either `endofmonth` or `specialrequest` returns an exit status of zero.

In Chapter 8 you'll learn about how to write complex flow control loops in your programs. But before you get there, try the exercises that follow using the `if`, `case`, `&&` and `||` notations explained in this chapter.

'Round and 'Round She Goes

In this chapter you'll learn how to set up program loops. These loops will enable you to execute a set of commands either a specified number of times or until a specific end condition is met.

The three built-in looping commands for shell programming are

- `for`
- `while`
- `until`

You'll learn about each one of these loops in separate sections of this chapter.

The `for` Command

The `for` command is used to execute one or more commands a specified number of times.

Its basic format is as shown:

```
for var in word1 word2 ... wordn
do
    command
    command
    ...
done
```

The commands enclosed between the `do` and the `done` are what's known as the *body* of the loop and are executed for as many items as are listed after the `in`. When the loop is executed, the first word, `word1`, is assigned to the variable `var`, and the body of the loop is then executed. Next, the second word in the list, `word2`, is assigned to `var`, and the body of the loop is executed again.

This process continues with successive words in the list being assigned to `var` and the commands in the loop body being executed until the last word in the list, `wordn`, is assigned to `var` and the body of the loop executed. At that point, no words are left in the list, and execution of the `for` command is then complete. Execution then continues with the command that immediately follows the `done`.

If there are n words listed after the `in`, the body of the loop will have been executed a total of n times when the loop has finished.

Here's a loop that will be executed three times:

```
for i in 1 2 3
do
    echo $i
done
```

To try it out, type this in directly at the terminal, just like any other shell command:

```
$ for i in 1 2 3
> do
>     echo $i
> done
1
2
3
$
```

While the shell is waiting for the `done` to be typed to complete the `for` command, it keeps showing the secondary command prompt. When the user enters `done`, the shell then proceeds to execute the loop. Because three items are listed after the `in` (1, 2, and 3), the body of the loop—in this case a single `echo` command—will be executed a total of three times.

The first time through the loop, the first value in the list, 1, is assigned to the variable `i`. Then the body of the loop is executed. This displays the value of `i` at the terminal. Then the next word in the list, 2, is assigned to `i` and the `echo` command re-executed, resulting in the display of 2 at the terminal. The third word in the list, 3, is assigned to `i` the third time through the loop and the `echo` command executed. This results in 3 being displayed at the terminal. At that point, no more words are left in the list, so execution of the `for` command is complete, and the shell displays the command prompt to let you know it's done.

Now let's back up to Chapter 6 and recall the `run` program that enabled you to run a file through `tbl`, `nroff`, and `lp`:

```
$ cat run
tbl $1 | nroff -mm -Tlp | lp
$
```

If you wanted to run the files `memo1` through `memo4`, you could type the following at the terminal:

```
$ for file in memo1 memo2 memo3 memo4
> do
```

```

>         run $file
> done
request id is laser1-33 (standard input)
request id is laser1-34 (standard input)
request id is laser1-35 (standard input)
request id is laser1-36 (standard input)
$

```

The four values `memo1`, `memo2`, `memo3`, and `memo4` will be assigned in turn to the variable `file` and the `run` program will be executed with that value as the argument. Execution will be just as if you typed in four commands:

```

$ run memo1
request id is laser1-33 (standard input)
$ run memo2
request id is laser1-34 (standard input)
$ run memo3
request id is laser1-35 (standard input)
$ run memo4
request id is laser1-36 (standard input)
$

```

The shell permits filename substitution in the list of words in the `for` statement, so the previous loop could have also been written this way:

```

for file in memo[1-4]
do
    run $file
done

```

If you wanted to print all the files in your current directory using the `run` program, you could type

```

for file in *
do
    run $file
done

```

To do something more sophisticated, imagine `filelist` contains a list of the files that you want to run through `run`. You can type

```

files=$(cat filelist)

for file in $files
do
    run $file
done

```

to run each of the files, or, more succinctly,

```

for file in $(cat filelist)
do
    run $file
done

```

The better way to address this is to actually improve the `run` script itself, however, and it turns out that the `for` statement is perfect for the job:

```
$ cat run
#
# process files through nroff -- version 2
#
for file in $*
do
    tbl $file | nroff -rom -Tlp | lp
done
$
```

Recall that the special shell variable `$*` stands for *all* the arguments typed on the command line. If you executed the new version of `run` by typing

```
run memo1 memo2 memo3 memo4
```

the `$*` in the `for`'s list would be replaced by the four arguments `memo1`, `memo2`, `memo3`, and `memo4`. Of course, you could also type

```
run memo[1-4]
```

to achieve the same results.

The `$@` Variable

While we're utilizing `$*`, let's have a closer look at how it and its cousin `$@` work. To do that, let's write a program called `args` that displays all the arguments typed on the command line, one per line.

```
$ cat args
echo Number of arguments passed is $#

for arg in $*
do
    echo $arg
done
$
```

Now to try it:

```
$ args a b c
Number of arguments passed is 3
a
b
c
$ args 'a b' c
```

```
Number of arguments passed is 2
a
b
c
$
```

Look closely at the second example: even though 'a b' was passed as a single argument to `args`, it was split into two values within the `for` loop. That's because the `$*` in the `for` command was replaced by the shell with `a b c` and the quotes were lost. Thus the loop was executed three times.

The shell replaces the value of `$*` with `$1`, `$2`, ... , but if you instead use the special shell variable `"$@"` the values will be passed with `"$1"`, `"$2"`, The key difference is the double quotes around the `$@`: without them this variable behaves just like `$*`.

Go back to the `args` program and replace the unquoted `$*` with `"$@"`:

```
$ cat args
echo Number of arguments passed is $#

for arg in "$@"
do
    echo $arg
done
$
```

Now try it:

```
$ args a b c
Number of arguments passed is 3
a
b
c
$ args 'a b' c
Number of arguments passed is 2
a b
c
$ args
Number of arguments passed is 0
$
```

Try it with no arguments

In the last case, no arguments were passed to the program so the variable `"$@"` was replaced by *nothing*. The net result is that the body of the loop was not executed at all.

The for Without the List

A special notation is recognized by the shell when writing `for` commands. If you omit the `in` element and its subsequent list

```

for var
do
    command
    command
    ...
done

```

the shell automatically sequences through all the arguments typed on the command line, just as if you had written

```

for var in "$@"
do
    command
    command
    ...
done

```

With that in mind, here's the third and last version of the `args` program:

```

$ cat args
echo Number of arguments passed is $#

for arg
do
    echo $arg
done
$ args a b c
Number of arguments passed is 3
a
b
c
$ args 'a b' c
Number of arguments passed is 2
a b
c
$

```

The while Command

The second type of looping command is the `while` statement. The format of this command is

```

while commandt
do
    command
    command
    ...
done

```

*command*_t is executed and its exit status tested. If it's zero, the commands enclosed between the `do` and `done` are executed once. Then *command*_t is executed again and its exit status tested.

If it's zero, the commands enclosed between the `do` and `done` are once again executed. This continues until `command_c` returns a nonzero exit status. At that point, execution of the loop is terminated. Execution then proceeds with the command that follows the `done`.

Note that the commands between the `do` and `done` might never be executed if `command_c` returns a nonzero exit status the first time it's executed.

Here's a program called `twhile` that simply counts to 5:

```
$ cat twhile
i=1

while [ "$i" -le 5 ]
do
    echo $i
    i=$((i + 1))
done
$ twhile          Run it
1
2
3
4
5
$
```

The variable `i` is initially set to the value 1. Then the `while` loop is entered, succeeding on the conditional test so the code block is executed. The shell continues execution as long as `i` is less than or equal to 5. Inside the loop, the value of `i` is displayed at the terminal, then incremented by one.

The `while` loop is often used in conjunction with the `shift` command to process an unknown number of arguments typed on the command line.

Consider the next program, called `prargs`, which prints each of the command-line arguments out, one per line.

```
$ cat prargs
#
# Print command line arguments one per line
#

while [ "$#" -ne 0 ]
do
    echo "$1"
    shift
done
$ prargs a b c
a
b
c
```

```

$ prargs 'a b' c
a b
c
$ prargs *
addresses
intro
lotsaspaces
names
nu
numbers
phonebook
stat
$ prargs      No arguments
$

```

While the number of arguments is not equal to zero, the value of \$1 is displayed and then a `shift` is invoked to shift down the variables (that is, \$2 to \$1, \$3 to \$2, and so on) and also decrement \$#. When the last argument has been displayed and shifted out, \$# will equal zero, at which point execution of the `while` will be terminated.

Note that if no arguments are given to `prargs` (as was done in the last case), the `echo` and `shift` are never executed because \$# is equal to zero as soon as the loop is entered.

The `until` Command

The `while` command continues execution as long as the test expression continues to return a TRUE (zero) exit status. The `until` command is the opposite: It continues executing the code block until the test expression returns a *nonzero* exit status and stops once a zero status is produced.

Here is the general format of the `until`:

```

until commandt
do
    command
    command
    ...
done

```

Like the `while`, the commands between the `do` and `done` might never be executed if *command_t* returns a zero exit status the first time it's executed.

While the two commands are quite similar, the `until` command is useful for writing programs that wait for a particular event to occur. For example, suppose that you want to see whether `sandy` is logged on because you have to give her something important. You could send her electronic mail, but you know that she usually doesn't get around to reading her mail until late in the day. You could use the `on` program from Chapter 7 to see whether `sandy`'s logged on:

```

$ on sandy
sandy is not logged on
$

```

Simple, but ineffective because it runs once and is done. You could run the program periodically throughout the day (rather tedious), or, better, you could write your own program to continually check until she does log in!

Let's call the program `waitfor` and have it take a single argument: the name of the user you want to monitor. Instead of having the program continually check for that user logging on, however, let's have it check only once every minute. To do this, we'll have to use a command called `sleep`, which suspends execution of a program for a specified number of seconds.

The command

```
sleep n
```

suspends execution of the program for `n` seconds. At the end of that interval, the program resumes execution where it left off—with the command that immediately follows `sleep`.

```
$ cat waitfor
#
# Wait until a specified user logs on
#

if [ "$#" -ne 1 ]
then
    echo "Usage: waitfor user"
    exit 1
fi

user="$1"

#
# Check every 60 seconds for user logging on
#

until who | grep "^$user " > /dev/null
do
    sleep 60
done

#
# When we reach this point, the user has logged on
#
echo "$user has logged on"
$
```

After checking that exactly one argument was provided, the program assigns `$1` to `user`. Then an `until` loop is entered that will be executed until the `grep` exit status is zero; that is, until the specified user logs on. As long as the user isn't logged on, the body of the loop—the `sleep` command—is executed to suspend execution for 60 seconds. At the end of the minute, the pipeline listed after the `until` is re-invoked and the process is repeated.

When the `until` loop is exited—signaling that the monitored user has logged on—a message is displayed at the terminal to that effect and the script is done.

```
$ waitfor sandy           Time passes
sandy has logged on
$
```

Of course, running the program as shown here is not very practical because it ties up your terminal until `sandy` logs on. A better idea is to run `waitfor` in the background so that you can use your terminal for other work:

```
$ waitfor sandy &           Run it in the background
[1] 4392                   Job number and process id
$ nroff newmemo           Do other work
...
sandy has logged on       Happens sometime later
```

Now you can do other work and the `waitfor` program continues executing in the background until `sandy` logs on, or until you log off the system.

Note

By default, all your processes are automatically terminated when you log off the system. If you want a program to continue running after you've logged off, you can run it with the `nohup` command, or schedule it to run with `at` or from `cron`. Consult your Unix User's Manual for more details.

Because `waitfor` only checks once per minute for the user logging on, it won't consume many system resources while it's running (an important consideration when running programs in the background).

Unfortunately, after the specified user logs on, there's a chance you might miss the one-line notification message. If you're editing a file with a screen editor such as `vi`, the notification message could turn your screen into a mess, and you still might not be able to read it!

A better alternative might be to mail it to yourself instead. Heck, you can let the user choose which they'd prefer by adding an option to the program that, if selected, indicates that the message is to be mailed. If not selected, the message is then displayed at the terminal.

In the version of `waitfor` that follows, a `-m` option has been added for this purpose:

```
$ cat waitfor
#
# Wait until a specified user logs on -- version 2
#

if [ "$1" = -m ]
then
    mailopt=TRUE
    shift
```

```

else
    mailopt=FALSE
fi

if [ "$#" -eq 0 -o "$#" -gt 1 ]
then
    echo "Usage: waitfor [-m] user"
    echo "    -m means to be informed by mail"
    exit 1
fi

user="$1"

#
# Check every minute for user logging on
#

until who | grep "^$user " > /dev/null
do
    sleep 60
done

#
# When we reach this point, the user has logged on
#

if [ "$mailopt" = FALSE ]
then
    echo "$user has logged on"
else
    echo "$user has logged on" | mail steve
fi
$

```

The first test checks to see whether the `-m` option was specified. If it was, `mailopt` is assigned the value `TRUE`, and `shift` is executed to “shift out” the first argument (moving the name of the user to be monitored to `$1` and decrementing `$#`). If the `-m` option wasn’t specified, `mailopt` is set to `FALSE`.

Execution then proceeds as in the previous version, except this time when the main block of code completes, the `mailopt` variable is tested to determine whether to output the notification via email or as an `echo` statement.

```

$ waitfor sandy -m
Usage: waitfor [-m] user
    -m means to be informed by mail
$ waitfor -m sandy &
[1] 5435

```

```

$ vi newmemo                                Work continues
...
you have mail
$ mail
From steve Wed Aug 28 17:44:46 EDT 2002
sandy has logged on

?d
$

```

Of course, we could have written `waitfor` to accept the `-m` option as either the first or second argument, but that's not how traditional Unix syntax works: all options are expected to precede any other types of arguments on the command line.

Also note that the old version of `waitfor` could have been executed as follows:

```

$ waitfor sandy | mail steve &
[1] 5522
$

```

to achieve the same result as adding the `-m` option, but it's considerably less elegant.

The program always sends mail to `steve` as it's written now, which isn't particularly useful if someone else wants to run it. A better way is to determine the user running the program and then send them the mail if they specify the `-m` option. But how do you do that? One way is to execute the `who` command with the `am i` options and get the user name that comes back. You can then use `cut` to extract the username from the `who` output and use that name as the recipient of the mail.

All of this can be done in the last `if` command of `waitfor` if it's changed to read as shown:

```

if [ "$#" -eq 1 ]
then
    echo "$user has logged on"
else
    runner=$(who am i | cut -c1-8)
    echo "$user has logged on" | mail $recipient
fi

```

Now the program can be run by anyone, and the mail notification will be sent to the correct recipient.

More on Loops

Breaking Out of a Loop

Sometimes program logic dictates an immediate exit from a loop statement. To exit from the loop but not from the program, use the `break` command:

```
break
```

When the `break` is executed, control is immediately moved outside of the loop, where execution then continues as normal.

One common way this is used is with an infinite loop, a block of code that is intended to go around and around executing the same commands until `break` stops it.

In these situations the command `true` can be used to return an exit status of zero. The command `false` can be used in the opposite situation too, as it returns a nonzero exit status. If you write

```
while true
do
    ...
done
```

the `while` loop will be executed forever, because `true` always returns a zero exit status.

Because `false` always returns a nonzero exit status, the loop

```
until false
do
    ...
done
```

will also execute forever.

The `break` command is therefore used to exit from these sorts of infinite loops, usually when an error condition or the end of processing is detected:

```
while true
do
    cmd=$(getcmd)

    if [ "$cmd" = quit ]
    then
        break
    else
        processcmd "$cmd"
    fi
done
```

Here the `while` loop will continue to execute the `getcmd` and `processcmd` programs until `cmd` is equal to `quit`. At that point, the `break` command will be executed, causing the loop to be exited.

If the `break` command is used in the form

```
break n
```

the `n` innermost loops are immediately exited, so in

```
for file
do
    ...
```

```

while [ "$count" -lt 10 ]
do
    ...
    if [ -n "$error" ]
    then
        break 2
    fi
    ...
done
...
done

```

both the `while` *and* the `for` loops will be exited if `error` is nonnull.

Skipping the Remaining Commands in a Loop

The `continue` command is similar to `break`, only it doesn't cause the loop to be exited, just the remaining commands in the current iteration of the loop to be skipped. The program moves immediately to the next iteration of the loop and continues as normal. Like the `break`, an optional number can follow the `continue`, so

```
continue n
```

causes the commands in the innermost *n* loops to be skipped, after which execution of the program continues as normal.

```

for file
do
    if [ ! -e "$file" ]
    then
        echo "$file not found!"
        continue
    fi

    #
    # Process the file
    #

    ...
done

```

Each value of `file` is checked to make sure that the file exists. If it doesn't, a message is printed, and further processing of the file within the `for` loop is skipped. Execution continues with the next value in the list.

The preceding example is equivalent to writing

```

for file
do
    if [ ! -e "$file" ]
    then

```

```

        echo "$file not found!"
    else
        #
        # Process the file
        #
        ...
    fi
done

```

Executing a Loop in the Background

An entire loop can be sent to the background for execution simply by placing an ampersand after the `done` statement:

```

$ for file in memo[1-4]
> do
>     run $file
> done &                                Send it to the background
[1] 9932
$
request id is laser1-85 (standard input)
request id is laser1-87 (standard input)
request id is laser1-88 (standard input)
request id is laser1-92 (standard input)

```

This—and subsequent examples—work because the shell treats loops as if they were mini-programs of their own, so whatever appears after block closing statements like `done`, `fi` and `esac` can have redirects, be put into background with the ampersand or even form part of a pipeline of commands.

I/O Redirection on a Loop

You can also perform I/O redirection on a loop. Input redirected into the loop applies to all commands in the loop that read their data from standard input. Output redirected from the loop to a file applies to all commands in the loop that write to standard output. And it all happens at the loop closing statement `done`:

```

$ for i in 1 2 3 4
> do
>     echo $i
> done > loopout                        Redirect loop's output to loopout
$ cat loopout
1
2
3
4
$

```

Individual statements can override block redirection, just as any other statements in your shell programs can explicitly read from a specified source or send output to a specified destination.

To force input or output to come from or go to the terminal, utilize `/dev/tty`, which always refers to your terminal program, whether you're on a Mac, Linux, or Unix system.

In the following loop, all output is redirected to the file `output` except the `echo` command's output, which is explicitly redirected to the terminal:

```
for file
do
    echo "Processing file $file" > /dev/tty
    ...
done > output
```

You can also redirect the standard error output from a loop, simply by tacking on a `2> file` after the `done`:

```
while [ "$endofdata" -ne TRUE ]
do
    ...
done 2> errors
```

Here output from all commands in the loop writing to standard error will be redirected to the file `errors`.

A variation of the `2>` format is commonly used to ensure that error messages go to the terminal even when a script might have its output redirected into a file or pipe:

```
echo "Error: no file" 1>&2
```

By default, `echo` sends its output to standard output (file descriptor 1), while file descriptor 2 remains standard error and is not redirected on file redirection or pipes by default. So the notation above means that the error message from `echo` should have its "file #1" output redirected to "file #2", that is, standard error. You can test this with code like this:

```
for i in "once"
do
    echo "Standard output message"
    echo "Error message" 1>&2
done > /dev/null
```

Try it yourself and see what happens.

Piping Data into and out of a Loop

A command's output can be piped into a loop (by having the commands prior to the loop command end with a pipe symbol), and the output from a loop can be piped into another command too. Here's an example of the output from a `for` command piped into `wc`:

```
$ for i in 1 2 3 4
> do
```

```
>         echo $i
> done | wc -l
      4
$
```

Typing a Loop on One Line

If you find yourself frequently typing in loops directly at the command line, you might want to try the following shorthand notation to type in an entire command on a single line: Put a semicolon after the last item in the list and one after each command in the loop (but not after the `do`).

Using this shorthand, the loop

```
for i in 1 2 3 4
do
    echo $i
done
```

can be written

```
for i in 1 2 3 4; do echo $i; done
```

You can type it in directly on the command line this way:

```
$ for i in 1 2 3 4; do echo $i; done
1
2
3
4
$
```

The same rules apply to `while` and `until` loops.

`if` commands can also be typed on the same line using a similar format:

```
$ if [ 1 = 1 ]; then echo yes; fi
yes
$ if [ 1 = 2 ]; then echo yes; else echo no; fi
no
$
```

Note that no semicolons appear after the `then` and the `else`.

Many shell programmers use a hybrid structure where `if` statements are structured thusly:

```
if [ condition ] ; then
    command
fi
```

This simple usage of the semicolon can help increase the readability of your shell programs and is worth considering as part of your own code formatting.

The `getopts` Command

Let's extend the `waitfor` program further by adding a `-t` option that specifies how frequently, in seconds, to perform the check. Now `waitfor` takes both `-m` and `-t` options. We'll allow these options to be specified in any order on the command line, as long as they appear before the name of the user that we're monitoring. So valid `waitfor` command lines look like this:

```
waitfor ann
waitfor -m ann
waitfor -t 600 ann
waitfor -m -t 600 ann
waitfor -t 600 -m ann
```

and invalid ones look like this:

```
waitfor                Missing user name
waitfor -t600 ann      Need a space after -t
waitfor ann -m         Options must appear first
waitfor -t ann         Missing argument after -t
```

As you start writing code to allow this sort of flexibility on the command line, you will soon discover that it can become quite complicated!

Don't fret, though; the shell provides a built-in command called `getopts` that makes it easy to process command line arguments. The general format of the command is

```
getopts options variable
```

We'll dig into the options string shortly. For now, just know that letter-only options are specified as such and options that have a required argument have a trailing colon, so "`ab:c`" means that `-a` and `-c` are allowed, as is `-b`, but `-b` requires an additional parameter to be specified.

The `getopts` command is designed to be executed within a loop, however, because it makes it easy to take whatever actions are required for each of the user specified options. Each time through the loop, `getopts` examines the next command line argument and determines whether it is a valid option by checking to see whether the argument begins with a minus sign and is followed by any of the letters specified as *options*. If it does, `getopts` stores the matching option letter inside the specified *variable* and returns a zero exit status. You'll see what I mean in just a few lines ...

If the letter that follows the minus sign is *not* listed in *options*, `getopts` stores a question mark inside *variable* before returning with a zero exit status. It also writes an error message to standard error about the bad parameter that the user specified.

If no more arguments are left on the command line or if the current argument doesn't begin with a minus sign, `getopts` returns a nonzero exit status, allowing the script to then process any subsequent arguments. Think of the command `ls -C /bin` in this context: `-C` is a flag that could be parsed and processed by `getopts`, while `/bin` is an argument to the `ls` command itself, processed after all the starting arguments are dealt with.

Don't get too anxious if this seems really confusing. The fact is, it is all very complicated, so let's look at an example so you can see how `getopts` works. Suppose for a script you're writing you want to use `getopts` to recognize the options `-a`, `-i`, and `-r`. Your `getopts` call might look like this:

```
getopts "air" option
```

Here the first argument—`air`—specifies the three acceptable command flags (`-a`, `-i`, and `-r`) and `option` is the name of the variable that `getopts` will use to store each matching value encountered.

The `getopts` command also allows options to be clustered or grouped together on the command line. This is done by following a single minus sign with more than one consecutive option. For example, our `foo` command can be executed like this:

```
foo -a -r -i
```

or like this:

```
foo -ari
```

using this simple grouping feature.

But wait, `getopts` is far more powerful than what we've explained so far! For example, it can also handle the case where an option requires an additional argument. For example, the new `-t` option to be added to the `waitfor` command requires an argument too.

To properly parse arguments subsequent to a user-specified option, `getopts` requires that the command be invoked with at least one space separating the option from the argument. In this instance, options cannot be grouped together.

To indicate to `getopts` that an option has a required argument, add a colon character after the option letter on the `getopts` command line. So the `waitfor` program, which allows both `-m` and `-t` options, the latter of which has a required additional argument, should call `getopts` like this:

```
getopts mt: option
```

If `getopts` doesn't find an argument after an option that requires one, it stores a question mark inside the variable and outputs an error message to standard error. Otherwise, it stores the character in the variable and the user specified argument inside a special variable called `OPTARG`.

One final note about `getopts`: Another special variable called `OPTIND` is initially set to 1 and is updated each time `getopts` returns to reflect the number of the *next* command line argument to be processed.

To make this clearer, here is the third version of `waitfor` that uses the `getopts` command to process the command line arguments. It also incorporates the previously noted change to send mail to the user running the program.

```

$ cat waitfor
#
# Wait until a specified user logs on -- version 3
#

# Set up default values

mailopt=FALSE
interval=60

# process command options

while getopts mt: option
do
    case "$option"
    in
        m) mailopt=TRUE;;
        t) interval=$OPTARG;;
        \?) echo "Usage: waitfor [-m] [-t n] user"
            echo "    -m means to be informed by mail"
            echo "    -t means check every n secs."
            exit 1;;
    esac
done

# Make sure a user name was specified

if [ "$OPTARG" -gt "$#" ]
then
    echo "Missing user name!"
    exit 2
fi

shiftcount=$((OPTARG - 1))
shift $shiftcount
user=$1

#
# Check for user logging on
#

until who | grep "^$user " > /dev/null
do
    sleep $interval
done

#
# When we reach this point, the user has logged on
#

```

```

if [ "$mailopt" = FALSE]
then
    echo "$user has logged on"
else
    runner=$(who am i | cut -c1-8)
    echo "$user has logged on" | mail $runner
fi

```

```

$ waitfor -m
Missing user name!
$ waitfor -x fred Illegal option
waitfor: illegal option -- x
Usage: waitfor [-m] [-t n] user
    -m means to be informed by mail
    -t means check every n secs.
$ waitfor -m -t 600 ann & Check every 10 min. for ann
[1] 5792
$

```

Let's look at the last line more closely. When the line

```
waitfor -m -t 600 ann &
```

is executed, the following occurs inside the `while` loop: `getopts` is invoked and stores the character `m` inside the variable `option`, sets `OPTIND` to 2, and returns a zero exit status.

The `case` command then determines what was stored inside `option`. A match on the character `m` indicates that the "send mail" option was selected, so `mailopt` is set to `TRUE`. (Note that the `?` inside the `case` is quoted. This is to remove its special meaning as a pattern matching character from the shell.)

The second time `getopts` is executed, `getopts` stores the character `t` inside `option`, stores the next command line argument (600) inside `OPTARG`, sets `OPTIND` to 3, and returns a zero exit status. The `case` command then matches the character `t` stored inside `option`. Then the code associated with that case copies the value of 600 that was stored in `OPTARG` into the variable `interval`.

The third time `getopts` is executed, `getopts` returns a nonzero exit status, indicating that it's reached the end of the user-specified command options.

The program then checks the value of `OPTIND` against `$#` to make sure that a username was typed on the command line. If `OPTIND` is greater than `$#` , then no more arguments remain and the user forgot the user name argument. Otherwise, the `shift` command is used to move the user name argument into `$1` . The actual number of places to shift is one less than the value of `OPTIND`.

The rest of the `waitfor` program remains as before; the only change is the use of the `interval` variable to specify the number of seconds to sleep.

If your head's a bit awlirl with `getopts` and its use, don't worry, it'll keep showing up in subsequent shell programs, and you'll get the hang of it with more exposure. It is worth studying for advanced shell programming too, because manually parsing anything more than a single command flag is prohibitively inefficient otherwise.

Reading and Printing Data

In this chapter you'll learn how to read data from the terminal or from a file using the `read` command and how to write formatted data to standard output using the `printf` command.

The `read` Command

The general format of the `read` command is

```
read variables
```

When this command is executed, the shell reads a line from standard input and assigns the first word to the first variable listed in *variables*, the second word to the second variable, and so on. If there are more words on the line than there are variables listed, the excess words get assigned to the last variable. For example, the command

```
read x y
```

reads a line from standard input, storing the first word in variable *x*, and the remainder of the line in variable *y*. It follows from this that the command

```
read text
```

reads and stores an entire line into the shell variable *text*.

A Program to Copy Files

Let's put the `read` command to work by writing a simplified version of the `cp` command. We'll call it `mycp`, and we'll have it take two arguments: the source file and the destination file. If the destination file already exists, the program will warn the user and ask them if they want to proceed with the copy. If the answer is "yes," we'll proceed; otherwise the program will quit.

```
$ cat mycp
#
# Copy a file
#
```

```

if [ "$#" -ne 2 ] ; then
    echo "Usage: mycp from to"
    exit 1
fi

from="$1"
to="$2"

#
# See if the destination file already exists
#

if [ -e "$to" ] ; then
    echo "$to already exists; overwrite (yes/no)?"
    read answer

    if [ "$answer" != yes ] ; then
        echo "Copy not performed"
        exit 0
    fi
fi

#
# Either destination doesn't exist or "yes" was typed
#

cp $from $to      # proceed with the copy
$

```

Now let's give the program a quick test:

```

$ ls -C
Addresses      intro      lotsaspaces  mycp
names          nu         numbers      phonebook
stat
$ mycp
Usage: mycp from to
$ mycp names names2
$ ls -l names*
-rw-r--r--  1 steve  steve    43 Jul  20 11:12 names
-rw-r--r--  1 steve  steve    43 Jul  21 14:16 names2
$ mycp names numbers
numbers already exists; overwrite (yes/no)?
no
Copy not performed
$

```

What files? -C forces multicolumn output too

No arguments

Make a copy of names

Did it work?

Try to overwrite an existing file

Notice that if the file already exists, the `echo` command that prompts for the yes/no response is executed. The `read` command that follows causes the shell to wait for the user to type a response. What this shows is that the shell doesn't prompt the user when it's waiting for data; it's up to the programmer to add a useful prompt to the program.

The data that is typed is stored in the variable `answer` and is then tested against the characters `yes` to determine whether the copy process should proceed. The quotes around the reference to the variable `answer` in the test

```
[ "$answer" != yes]
```

are necessary in case the user just presses the `Enter` key without typing any data. In that case, the shell would store a null value in `answer` and, without the quotes, `test` would issue an error message.

Also note the use of the semicolon to move the `then` statements onto the same line as the `if` statement. This is a common shell programmer notational trick, as mentioned in the previous chapter.

Special echo Escape Characters

A slight annoyance with `mycp` is that after the `echo` command is run, the response typed by the user appears on the next line. This happens because the `echo` command automatically adds a terminating newline character after the last argument.

Fortunately, this can be suppressed if the last two characters given to `echo` are the special *escape* characters `\c`. This tells `echo` to omit the newline after displaying the last argument. If you changed the `echo` command in `mycp` to read like this:

```
echo "$to already exists; overwrite (yes/no)? \c"
```

The user's input would be typed right after the message on the same line. Bear in mind that the `\c` is interpreted by `echo` and not by the shell, meaning that it must be quoted so that the backslash makes it to `echo`.

Note

Some Linux and Mac OS X systems have shells that don't interpret these `echo` escape characters, so the above would be shown as

```
newfile.txt already exists; overwrite (yes/no)? \c
```

If testing reveals that your shell works like that, change those specific invocations of `echo` to the separate program `/bin/echo` and they'll work fine. All your other `echo` statements can remain as just regular `echo` commands, of course.

The `echo` command can also interpret other special characters (see note if yours doesn't work as expected). These must each be preceded by a backslash and are summarized in Table 9.1.

Table 9.1 echo Escape Characters

Character	Prints
<code>\b</code>	Backspace
<code>\c</code>	The line without a terminating newline
<code>\f</code>	Formfeed
<code>\n</code>	Newline
<code>\r</code>	Carriage return
<code>\t</code>	Tab character
<code>\\</code>	Backslash character
<code>\0nnn</code>	The character whose ASCII value is <i>nnn</i> , where <i>nnn</i> is a one- to three-digit octal number

An Improved Version of `mycp`

Suppose that you have a program called `prog1` in your current directory and you want to copy it into your `bin` directory. With the regular `cp` program, you could use the shortcut of just specifying the destination directory to have the file copied there with its existing filename. But take another look at the `mycp` program and determine what happens if you type in

```
mycp prog1 bin
```

The `-e` test on `bin` will succeed (because `-e` tests for existence of a file), and `mycp` will display the “already exists” message and wait for a yes/no answer. That’s a dangerous mistake, particularly if the user types `yes`!

If the second argument is a *directory*, `mycp` should instead check to see whether the `from` file exists *inside* the specified directory.

The next version of `mycp` performs this check. It also has the modified `echo` command that includes the `\c` to suppress the terminating newline.

```
$ cat mycp
#
# Copy a file -- version 2
#

if [ "$#" -ne 2 ] ; then
    echo "Usage: mycp from to"
    exit 1
fi

from="$1"
to="$2"
```

```

#
# See if destination file is a directory
#

if [ -d "$to" ] ; then
    to="$to/${basename $from}"
fi

#
# See if the destination file already exists
#

if [ -e "$to" ] ; then
    echo "$to already exists; overwrite (yes/no)? \c"
    read answer

    if [ "$answer" != yes ] ; then
        echo "Copy not performed"
        exit 0
    fi
fi

#
# Either destination doesn't exist or "yes" was typed
#

cp $from $to      # proceed with the copy
$

```

If the destination file is a directory, the program changes the variable `to` to more precisely identify the destination filename by including the directory name: `$to/${basename $from}`. This ensures that the subsequent test for the existence of the ordinary file `$to` will be done on the file in the directory, not on the directory itself.

The `basename` command gives the base filename of its argument with all directory components stripped away (for example, `basename /usr/bin/troff` produces `troff`; `basename troff` also produces `troff`). This extra step ensures that the copy is made from and to the correct place. (As an example, if `mycp /tmp/data bin` is typed, where `bin` is a directory, you want to copy `/tmp/data` into `bin/data` and not into `bin/tmp/data`.)

Here's some sample output. Note the effect of the `\c` escape characters.

```

$ ls                      Check out current directory
bin
prog1
$ ls bin                  Look inside bin
lu
nu
prog1

```

```
$ mycp prog1 prog2    Simple case
$ mycp prog1 bin      Copy into directory
bin/prog1 already exists; overwrite (yes/no)? yes
$
```

A Final Version of mycp

The last modification to `mycp` makes the program virtually equivalent to the standard Linux `cp` command by allowing a variable number of arguments. Recall that with the standard command any number of files can precede the name of a directory, as in

```
cp prog1 prog2 greetings bin
```

To modify `mycp` to accept any number of files in a similar format, you can use this approach:

1. Get each argument but the last from the command line and store it in the shell variable `filelist`.
2. Store the last argument in the variable `to`.
3. If `$to` is not a directory, test the argument count as there must be exactly two arguments.
4. If `$to` is a directory, for each file in `$filelist`, check whether the file already exists in the destination directory. If it doesn't, add the filename to the variable `copylist`. If it does exist, ask the user whether the file should be overwritten. If the answer is `yes`, add the filename to `copylist`.
5. If `copylist` is non-null, copy the files in it to `$to`.

If this algorithm seems a bit fuzzy, the program and a detailed explanation will help clear things up. Note the modified command usage message.

```
$ cat mycp
#
# Copy a file -- final version
#

numargs=$#                # save this for later use
filelist=
copylist=

#
# Process the arguments, storing all but the last in filelist
#

while [ "$#" -gt 1 ] ; do
    filelist="$filelist $1"
    shift
done
```

```

to="$1"

#
# If less than two args, or if more than two args and last arg
# is not a directory, then issue an error message
#

if [ "$numargs" -lt 2 -o "$numargs" -gt 2 -a ! -d "$to" ] ; then
    echo "Usage: mycp file1 file2"
    echo "      mycp file(s) dir"
    exit 1
fi

#
# Sequence through each file in filelist
#

for from in $filelist ; do
    #
    # See if destination file is a directory
    #

    if [ -d "$to" ] ; then
        tofile="$to/${basename $from}"
    else
        tofile="$to"
    fi

    #
    # Add file to copylist if file doesn't already exist
    # or if user says it's okay to overwrite
    #

    if [ -e "$tofile" ] ; then
        echo "$tofile already exists; overwrite (yes/no)? \c"
        read answer

        if [ "$answer" = yes ] ; then
            copylist="$copylist $from"
        fi
    else
        copylist="$copylist $from"
    fi
done

```

```

#
# Now do the copy -- first make sure there's something to copy
#
if [ -n "$copylist" ] ; then
    cp $copylist $to      # proceed with the copy
fi
$

```

Let's look at some sample output before delving into the code itself.

```

$ ls -C                      See what's around
bin      lu      names      prog1
prog2
$ ls bin                      And what's in bin?
lu
nu
prog1
$ mycp                        No arguments
Usage: mycp file1 file2
       mycp file(s) dir
$ mycp names prog1 prog2     Last arg isn't a directory
Usage: mycp file1 file2
       mycp file(s) dir
$ mycp names prog1 prog2 lu bin Legitimate use
bin/prog1 already exists; overwrite (yes/no)? yes
bin/lu already exists; overwrite (yes/no)? no
$ ls -l bin                   See what happened
total 5
-rw-r--r--  1 steve  steve  543 Jul 19 14:10 lu
-rw-r--r--  1 steve  steve  949 Jul 21 17:11 names
-rw-r--r--  1 steve  steve   38 Jul 19 09:55 nu
-rw-r--r--  1 steve  steve  498 Jul 21 17:11 prog1
-rw-r--r--  1 steve  steve  498 Jul 21 17:11 prog2
$

```

In the last case, `prog1` was overwritten and `lu` wasn't, as per the user's request.

When the program starts execution, it saves the number of arguments in the variable `numargs`. This is done because the argument variables are changed later in the program by the `shift` command.

Next a loop is entered that is executed as long as the number of arguments is greater than one. The purpose of this loop is to get the last argument on the line. While doing this, the loop stashes away the other arguments into the shell variable `filelist`, which ultimately will contain a list of all the files to be copied. The statement

```
filelist="$filelist $1"
```

says to take the previous value of `filelist`, add on a space followed by the value of `$1`, and then store the result back into `filelist`. Then the `shift` command is executed to “move” all the arguments over by one. Eventually, `$#` will be equal to one, and the loop will be exited.

At that point, `filelist` will contain a space-delimited list of all the files to be copied, and `$1` will contain the last argument, which is either the destination filename or destination directory.

To see how this works, consider execution of the `while` loop when the command is executed as `mycp names prog1 prog2 lu bin`

Figure 9.1 depicts the changing values of the variables through each iteration of the loop. The first line shows the state of the variables before the loop is entered.

<code>\$#</code>	<code>\$1</code>	<code>\$2</code>	<code>\$3</code>	<code>\$4</code>	<code>\$5</code>	<code>filelist</code>
5	<code>names</code>	<code>prog1</code>	<code>prog2</code>	<code>lu</code>	<code>bin</code>	<code>null</code>
4	<code>prog1</code>	<code>prog2</code>	<code>lu</code>	<code>bin</code>		<code>names</code>
3	<code>prog2</code>	<code>lu</code>	<code>bin</code>			<code>names prog1</code>
2	<code>lu</code>	<code>bin</code>				<code>names prog1 prog2</code>
1	<code>bin</code>					<code>names prog1 prog2 lu</code>

Figure 9.1 Processing command line arguments

After the loop is exited, the last argument contained in `$1` is stored in the variable `to`. Next a test is made to ensure that at least two arguments were typed on the command line and, if more than two were typed, that the last argument is a directory. If either condition is not satisfied, usage information is displayed to the user, and the program exits with a status of 1.

Following this, the `for` loop examines each file in the list to see whether it already exists in the destination directory. If it does, the user is prompted as before. If the user wants to overwrite the file—or if the file doesn’t exist—the file is added to the shell variable `copylist`. The technique used here is the same used to accumulate the arguments inside `filelist`.

When the `for` loop is exited, `copylist` contains a list of all the files to be copied. In an extreme case, notice that this list can be null if the user decided not to overwrite any files and every file specified already existed in the destination directory too. Therefore a test is made to ensure `copylist` is non-null, and if it is, the copy is performed.

Take some time to review the logic of the final version of `mycp`; it illustrates many of the features you’ve learned so far in this book. Some exercises at the end of this chapter will also test your understanding of this program.

A Menu-Driven Phone Program

One useful thing about the `read` command is that it enables you to write menu-driven shell programs. As an example, let’s return to the three phone book programs we wrote earlier,

add, lu, and rem, and create what's known as a *wrapper*, a program that makes other programs easier to use. This time we'll create the wrapper program `rolo` ("rolo" short for Rolodex, just in case you remember what a Rolodex is!).

When invoked, `rolo` will display a list of choices to the user and then execute the appropriate program depending on the selection after prompting for the necessary arguments:

```
$ cat rolo
#
# rolo - rolodex program to look up, add, and
#       remove people from the phone book
#
#
# Display menu
#
echo '
    Would you like to:

        1. Look someone up
        2. Add someone to the phone book
        3. Remove someone from the phone book

    Please select one of the above (1-3): \c'

#
# Read and process selection
#

read choice
echo ""
case "$choice"
in
    1) echo "Enter name to look up: \c"
        read name
        lu "$name";;
    2) echo "Enter name to be added: \c"
        read name
        echo "Enter number: \c"
        read number
        add "$name" "$number";;
    3) echo "Enter name to be removed: \c"
        read name
        rem "$name";;
    *) echo "Bad choice";;
esac
$
```

Notice how a single `echo` command is used to display the full multi-line menu, taking advantage of the fact that the quotes preserve formatting and embedded newlines. Then `read` gets the selection from the user and stores it in the variable `choice`.

A `case` statement determines what choice was made. If choice 1 was selected, the user wants to look up someone in the phone book. In that case, the user is asked to enter the desired name, and the `lu` program is called with the specified argument. Note also that the double quotes around `name` in

```
lu "$name"
```

are necessary to ensure that two or more words typed in by the user are handed to `lu` as a single argument.

A similar sequence occurs if the user selects menu items 2 or 3.

The programs `lu`, `rem`, and `add` are from earlier chapters.

Here are some sample runs of `rolo`:

```
$ rolo

Would you like to:

    1. Look someone up
    2. Add someone to the phone book
    3. Remove someone from the phone book
```

```
Please select one of the above (1-3): 2
```

```
Enter name to be added: El Coyote
```

```
Enter number: 212-567-3232
```

```
$ rolo Try it again
```

```
Would you like to:
```

- ```
 1. Look someone up
 2. Add someone to the phone book
 3. Remove someone from the phone book
```

```
Please select one of the above (1-3): 1
```

```
Enter name to look up: Coyote
```

```
El Coyote 212-567-3232
```

```
$ rolo Once again
```

```
Would you like to:
```

- ```
    1. Look someone up
    2. Add someone to the phone book
    3. Remove someone from the phone book
```

```
Please select one of the above (1-3): 4
```

```
Bad choice
```

```
$
```

When an invalid choice is entered, the program displays `Bad choice` and then terminates. A friendlier approach would be to loop around and again prompt the user until a proper choice is made. This can be done by enclosing the entire program inside an `until` loop that will be executed until a valid selection is made.

Another change to `rolod` reflects its most likely usage: Because the most common operation will be looking someone up, there will be a tendency to avoid typing `rolod`, then making selection 1, then typing the desired name. Instead, it's a lot easier to just type in

```
lu name
```

directly. Given this, let's give `rolod` some useful command line arguments so it can also be used as efficiently. By default if any arguments are specified, `rolod` will assume that a lookup is requested and call `lu` directly, handing all the arguments along. If the user wants to perform a quick lookup, they can type `rolod` followed by the name. If they want to get the full menu interface, typing just `rolod` offers just that alternative too.

The preceding two changes (looping until a valid choice is selected and doing a quick lookup) are added to version 2 of `rolod`:

```
$ cat rolod
#
# rolod - rolodex program to look up, add, and
#   remove people from the phone book -- version 2
#
#
# If arguments are supplied, then do a lookup
#

if [ "$#" -ne 0 ] ; then
    lu "$@"
    exit
fi

validchoice=""          # set it null

#
# Loop until a valid selection is made
#

until [ -n "$validchoice" ]
do
    #
    # Display menu
    #
```

```

echo '

Would you like to:

    1. Look someone up
    2. Add someone to the phone book
    3. Remove someone from the phone book

Please select one of the above (1-3): \c'

#
# Read and process selection
#
read choice
echo

case "$choice"
in
    1) echo "Enter name to look up: \c"
        read name
        lu "$name"
        validchoice=TRUE;;
    2) echo "Enter name to be added: \c"
        read name
        echo "Enter number: \c"
        read number
        add "$name" "$number"
        validchoice=TRUE;;
    3) echo "Enter name to be removed: \c"
        read name
        rem "$name"
        validchoice=TRUE;;
    *) echo "Bad choice";;
esac
done
$

```

If \$# is non-zero, `lu` is called directly with the arguments typed on the command line, then the program exits. Otherwise, the `until` loop is executed until the variable `validchoice` is non-null. Remember that the only way it will be assigned a value is if the command

```
validchoice=TRUE
```

is executed inside the `case` of either choice 1, 2, or 3. Otherwise, the program continues to loop.

```
$ rolo Bill
```

```
Billy Bach      201-331-7618
```

```
$ rolo
```

Quick lookup

Let's have the menu this time

Would you like to:

1. Look someone up
2. Add someone to the phone book
3. Remove someone from the phone book

Please select one of the above (1-3): 4

Bad choice

Would you like to:

1. Look someone up
2. Add someone to the phone book
3. Remove someone from the phone book

Please select one of the above (1-3): 0

Bad choice

Would you like to:

1. Look someone up
2. Add someone to the phone book
3. Remove someone from the phone book

Please select one of the above (1-3): 1

Enter name to look up: **Tony**

Tony Iannino 973-386-1295

\$

The \$\$ Variable and Temporary Files

If two or more people on your system use the `rollo` program at the same time, a potential problem may occur. Look at the `rem` program and see whether you can spot it. The problem occurs with the temporary file `/tmp/phonebook` that is used to create a new version of the phone book file.

The specific statements in the `rem` program look like this:

```
grep -v "$name" phonebook > /tmp/phonebook
mv /tmp/phonebook phonebook
```

But here's the problem: If more than one person uses `rollo` at the same time to remove an entry, there's a chance that the phone book file can get messed up because the same temporary file will be simultaneously used more than once. To be fair the chance of this happening is rather small, but it's non-zero and that means it's a problem.

There are two important concepts that this code raises, actually. The first is to do with how computers actually implement multitasking, by swapping individual programs in and out of the processor. The result is that at any point during execution, a program can be swapped out, even half-way through a series of commands. Now you can see the problem with the above code: because it's two statements, what happens if the program loses its place in line between the two statements and another instantiation of the program happens to run the exact same two lines of code? The second program overwrites the result of the first program's `grep` invocation. Not good for either user!

The second point relates to what's known as a *race condition*, a situation where more than one simultaneous invocation of a program can cause trouble. Most often that's related to temporary files, but it can also occur with sub-processes and lock files, as we'll discuss later in the book.

For now, just keep in mind that when writing shell programs that can be run by more than one person, make sure that each user's temporary files are unique.

One solution is to create temporary files in the user's home directory instead of `/tmp`. Another way is to choose a temporary filename that will be unique and different for each invocation of the program. A neat way to do this is to embed the unique process ID (PID) of the specific invocation into the filename. This is easily accomplished by referring to the special `$$` shell variable:

```
$ echo $$
4668
$ ps
  PID TTY TIME COMMAND
  4668 co  0:09 sh
  6470 co  0:03 ps
$
```

When substituted by the shell, `$$` becomes the process ID number of the login shell itself. Because each process on the system is given a unique process ID, using the value of `$$` in the name of a file eliminates the possibility of a different process using the same name. To fix the problem highlighted earlier, replace the two lines from `rem` with this improved sequence:

```
grep -v "$name" phonebook > /tmp/phonebook$$
mv /tmp/phonebook$$ phonebook
```

to side-step any potential race conditions. Each person using `rollo` will run it as a different process, so the temporary file used in each instance will be different. Problem solved.

The Exit Status from `read`

`read` returns an exit status of zero unless an end-of-file condition is encountered. If the data is coming from the terminal, this means that the user has pressed `Ctrl+d`. If the data is coming from a file, it means that there's no more data to read from the file.

This makes it easy to write a loop that will read lines of data from either a file or the terminal.

The next program, called `addi`, reads in lines containing pairs of numbers, which are added together; their sums are then written to standard output:

```
$ cat addi
#
# add pairs of integers on standard input
#

while read n1 n2
do
    echo $(( $n1 + $n2))
done
$
```

The `while` loop is executed as long as the `read` command returns an exit status of zero, which occurs as long as there's still data to be read. Inside the loop, the two values read from the line (presumably integers—no error checking is done here) are added up and the result written to standard output by `echo`.

```
$ addi
10 25
35
-5 12
7
123 3
126
Ctrl+d
$
```

Standard input for `addi` can be redirected from a file, and standard output can be another file (or a pipe, of course):

```
$ cat data
1234 7960
593 -595
395 304
3234 999
-394 -493
$ addi < data > sums
$ cat sums
9194
-2
699
4233
-887
$
```

The following program, called `number`, is a simplified version of the standard Unix `nl` command: it accepts one or more files as arguments and displays their contents with each line preceded by its line number. If no arguments are supplied, it reads standard input instead.

```
$ cat number
#
# Number lines from files given as argument or from
# standard input if none supplied
#

lineno=1

cat $* |
while read line
do
    echo "$lineno: $line"
    lineno=$((lineno + 1))
done
$
```

The variable `lineno`—the line number count—is initially set to 1. Then the arguments typed to `number` are given to `cat` to be collectively written to standard output. If no arguments are supplied, `$*` will be null, and `cat` will be passed no arguments. This will cause it to read from standard input. The output from `cat` is piped into the `while` loop.

Each line encountered by `read` is echoed at the terminal, prefaced by the current value of `lineno`, whose value is then incremented by one.

```
$ number phonebook
1: Alice Chebba      973-555-2015
2: Barbara Swingle  201-555-9257
3: Billy Bach       201-555-7618
4: El Coyote        212-555-3232
5: Liz Stachiw      212-555-2298
6: Susan Goldberg   201-555-7776
7: Teri Zak         201-555-6000
8: Tony Iannino     973-555-1295
$ who | number      Try from standard input
1: root      console Jul 25 07:55
2: pat       tty03    Jul 25 09:26
3: steve     tty04    Jul 25 10:58
4: george    tty13    Jul 25 08:05
$
```

Note that `number` won't work too well for lines that contain backslashes or leading whitespace characters. The following example illustrates this point.

```
$ number
      Here are some backslashes: \ \*
1: Here are some backslashes: *
$
```

Leading whitespace characters are removed from any line that's read. The backslash characters are also interpreted by the shell when it reads the line. You can use the `-r` option of `read` to prevent it from interpreting the backslash character. If we change the

```
while read line
in number to
while read -r line
```

the output will look better:

```
$ number
    Here are some backslashes: \ \*
1: Here are some backslashes: \ \*
$
```

In Chapter 11 you'll learn how to preserve the leading whitespace characters and also how to have some control over the parsing of the input data.

The printf Command

Although `echo` is quite adequate for displaying simple messages, sometimes you'll want to print *formatted* output: for example, lining up columns of data. Unix systems provide the `printf` command for these tasks. Those of you familiar with the C or C++ programming language will notice many similarities with their function of the same name.

The general format of the `printf` command is

```
printf "format" arg1 arg2 ...
```

where *format* is a string that details how the subsequent values are to be displayed. Since the format string is a single argument and is likely to contain special characters and spaces, it's always a good idea to enclose it in quotes.

Characters in the format string that are not preceded by a percent sign (`%`) are written directly to standard output. At its most simple, then, `printf` can work like `echo` (as long as you remember to end each line with `\n` for a newline, as shown):

```
$ printf "Hello world!\n"
Hello world!
$
```

Characters preceded by a percent sign are called *format specifications* and tell `printf` how the corresponding argument should be displayed. For each percent sign in the format string there should be a corresponding argument, except for the special specification `%%`, which causes a single percent sign to be displayed.

Let's start with a simple example of `printf`:

```
$ printf "This is a number: %d\n" 10
This is a number: 10
$
```

`printf` doesn't automatically add a newline character to the end of its output like `echo` but it does understand the same escape sequences (refer to Table 9.1 earlier in this chapter), so adding `\n` to the end of the format string causes the newline character sequence to also be printed and the command prompt to appear on the next line as expected.

Although the preceding is a simple example that could also be handled by `echo`, it helps to illustrate how the conversion specification (`%d`) is interpreted by `printf`: the format string is scanned and outputs each character in the string until it sees the percent sign. Then it reads the `d` and tries to replace the `%d` with the next argument given to `printf`, which must be an integer. After that argument (`10`) is sent to standard output, `printf` continues scanning the format string, sees the `\n`, and outputs a newline.

Table 9.2 summarizes the different format specification characters.

Table 9.2 `printf` Format Specification Characters

Character	Use for Printing
<code>%d</code>	Integers
<code>%u</code>	Unsigned integers
<code>%o</code>	Octal integers
<code>%x</code>	Hexadecimal integers, using a-f
<code>%X</code>	Hexadecimal integers, using A-F
<code>%c</code>	Single characters
<code>%s</code>	Literal strings
<code>%b</code>	Strings containing backslash escape characters
<code>%%</code>	Percent signs

The first five conversion specification characters are all used for displaying integers. `%d` displays signed integers, and `%u` displays unsigned integers; `%u` can also be used to display the positive representation of a negative number. By default, integers displayed as octal or hexadecimal numbers do not have a leading `0` or `0x`, but you can fix that if needed, as we'll show later in this section.

Strings are printed using `%s` or `%b`. `%s` is used to print strings literally, without any processing of backslash escape characters; `%b` is used to force interpretation of the backslash escape characters in the string argument.

Here are a few `printf` examples to clarify:

```
$ printf "The octal value for %d is %o\n" 20 20
The octal value for 20 is 24
$ printf "The hexadecimal value for %d is %x\n" 30 30
The hexadecimal value for 30 is 1e
```

```

$ printf "The unsigned value for %d is %u\n" -1000 -1000
The unsigned value for -1000 is 4294966296
$ printf "This string contains a backslash escape: %s\n" "test\nstring"
This string contains a backslash escape: test\nstring
$ printf "This string contains an interpreted
↳backslash escape: %b\n" "test\nstring"
This string contains an interpreted backslash escape: test string
$ printf "A string: %s and a character: %c\n" hello A
A string: hello and a character: A
$

```

In the last `printf`, `%c` is used to display a single character. If the corresponding argument is longer than one character, only the first is displayed:

```

$ printf "Just the first character: %c\n" abc
a
$

```

The general format of a conversion specification is

```
%[flags][width][.precision]type
```

The *type* is the conversion specification character from Table 9.2. As you can see, only the percent sign and *type* are required; the other parameters are called *modifiers* and are optional. Valid *flags* are `-`, `+`, `#`, and the space character.

`-` left-justifies the value being printed, which will make more sense when we discuss the *width* modifier.

`+` causes `printf` to precede integers with a `+` or `-` sign (by default, only negative integers are printed with a sign).

`#` causes `printf` to precede octal integers with `0` and hexadecimal integers with `0x` or `0X`, specified as `%#x` or `%#X`, respectively.

The space character causes `printf` to precede positive integers with a space and negative integers with a `-` for alignment purposes.

A few more examples. Pay close attention to the format strings!

```

$ printf "%+d\n%+d\n%+d\n" 10 -10 20
+10
-10
+20
$ printf "% d\n% d\n% d\n" 10 -10 20
 10
-10
 20
$ printf "%#o %#x\n" 100 200
0144 0xc8
$

```

As you can see, using + or space as the flag causes a column of positive and negative numbers to align nicely.

The *width* modifier is a positive number that specifies the minimum *field width* for printing an argument. The argument is right-justified within this field unless the - flag is used:

```
$ printf "%20s%20s\n" string1 string2
                string1                string2
$ printf "%-20s%-20s\n" string1 string2
string1                string2
$ printf "%5d%5d%5d\n" 1 10 100
    1    10   100
$ printf "%5d%5d%5d\n" -1 -10 -100
   -1   -10  -100
$ printf "%-5d%-5d%-5d\n" 1 10 100
1     10    100
$
```

The *width* modifier can be useful for lining up columns of text or numbers (Tip: signs for numbers and leading 0, 0x, and 0X characters are counted as part of the argument width). The *width* specifies a *minimum* size for the field, but if the width of an argument exceeds *width*, it can overflow or not be output at all. An easy way to test:

```
printf "%-15.15s\n" "this is more than 15 chars long"
```

What happens on your system when you try that command?

The *.precision* modifier is a positive number that specifies a minimum number of digits to be displayed for %d, %u, %o, %x, and %X. This results in *zero-padding* on the left of the value:

```
$ printf "%.5d %.4X\n" 10 27
00010 001B
$
```

For strings, the *.precision* modifier specifies the maximum number of characters to be printed from the string. If the string is longer than *precision* characters, it is truncated on the right. That's important to realize as it lets you line up text across multiple lines, but with some data missing if any individual value is wider than the specified field:

```
$ printf "%.6s\n" "Ann Smith"
Ann Sm
$
```

A *width* can be combined with *.precision* to specify both a field width and zero padding (for numbers) or truncation (for strings):

```
$ printf ":%#10.5x:%5.4x:%5.4d\n" 1 10 100
: 0x00001: 000a: 0100
$ printf ":%9.5s:\n" abcdefg
: abcde:
$ printf ":%-9.5s:\n" abcdefg
:abcde :
$
```

Finally, in case all of this isn't confusing enough, if a `*` is used in place of a number for *width* or *precision*, the argument *preceding* the value to be printed must be a number and will be used as the width or precision, respectively. If a `*` is used in place of both, two integer arguments must precede the value being printed and are used for the width and precision:

```
$ printf "%*s%*.2s\n" 12 "test one" 10 2 "test two"
    test one      te
$ printf "%12s%10.2s\n" "test one" "test two"
    test one      te
$
```

As you can see, the two `printf`s in this example produce the same result. In the first `printf`, 12 is used as the width for the first string, 10 as the width for the second string, and 2 as the precision for the second string. In the second `printf`, these numbers are specified as part of the format specification.

While the format specification for `printf` is unquestionably complex, its power and capabilities to turn the relatively unstructured output of `echo` into exactly what you want from your own shell programs is darn helpful. It's a command well worth studying more closely so you know how to use it as you develop your own more sophisticated programs.

Table 9.3 summarizes the various format specification modifiers.

Table 9.3 `printf` Format Specification Modifiers

Modifier	Meaning
<i>Flags</i>	
-	Left-justify value.
+	Precede integer with + or -.
(space)	Precede positive integer with space character.
#	Precede octal integer with 0, hexadecimal integer with 0x or 0X.
<i>width</i>	Minimum width of field; * means use next argument as width.
<i>precision</i>	Minimum number of digits to display for integers; maximum number of characters to display for strings; * means use next argument as precision.

Let's keep exploring `printf`. Here's a simple example that uses `printf` to align two columns of numbers from a file:

```
$ cat align
#
# Align two columns of numbers
# (works for numbers up to 12 digits long, including sign)
```

```
cat $* |
while read number1 number2
do
    printf "%12d %12d\n" $number1 $number2
done
$ cat data
1234 7960
593 -595
395 304
3234 999
-394 -493
$ align data
      1234          7960
      593          -595
      395           304
      3234          999
      -394         -493
$
```

In Chapters 11, 13, and 14 you'll see more examples of different uses for `printf`.

This page intentionally left blank

Your Environment

When you log on to your system, whether it's a shiny new Mac OS X Terminal app, a clean Linux install, or a Unix server in the back office, you're effectively given your own copy of the shell program. This login shell maintains what's known as your *environment*—a configuration that is distinct from other users on the system. This environment is maintained from the moment you log on until the moment you log off. In this chapter you'll learn about the shell environment and you'll see how it relates to writing and running programs.

Local Variables

Type the following program called `vartest` into your computer:

```
$ cat vartest
echo :$x:
$
```

`vartest` consists of a single `echo` command that displays the value of the variable `x` surrounded by colons.

Assign any value you want to the variable `x` from your terminal:

```
$ x=100
```

Question: What do you think will be displayed when `vartest` is now executed? Answer:

```
$ vartest
::
$
```

`vartest` doesn't know about the value of `x`. Therefore, its value is the default: null. The variable `x` that was assigned the value `100` in the login shell is known as a *local* variable. The reason why it has this name will become clear shortly.

Here's another example called `vartest2`:

```
$ cat vartest2
x=50
echo :$x:
$ x=100
$ vartest2           Execute it
:50:
$
```

Since the script changed the value of `x` from 100 to 50, the question is: What's the value of `x` after the script completes?

```
$ echo $x
100
$
```

You can see that `vartest2` didn't change the value of `x`, previously set to 100 in the interactive shell.

Subshells

The seemingly weird behavior exhibited by `vartest` and `vartest2` is due to the fact that these programs are run within *subshells* by your login shell. A subshell is essentially an entirely new shell just to run the desired program.

When you ask the login shell to execute `vartest`, it starts up a new shell to execute the program. Whenever a new shell runs, it runs in its own environment, with its own set of local variables. A subshell has no knowledge of local variables that were assigned values by the login shell (the *parent* shell). Furthermore, a subshell cannot change the value of a variable in the parent shell, as evidenced by `vartest2`.

Let's review the process that goes on here so you can better understand what's called the *scoping* of variables in shell programs: Before executing `vartest2`, your shell has a variable called `x` that has been assigned the value 100. This is depicted in Figure 10.1.

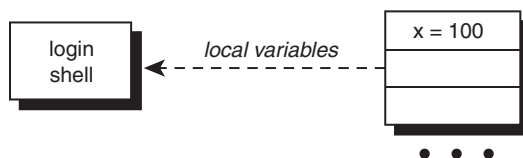

Figure 10.1 Login shell with `x=100`

When you invoke `vartest2`, your shell starts up a subshell to run it, giving it an *empty* list of local variables to start with (see Figure 10.2).

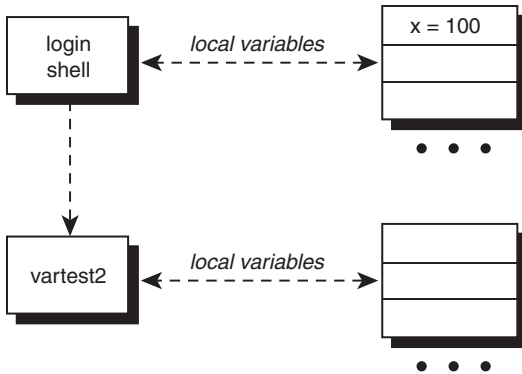

Figure 10.2 Login shell executes `vartest2`

After the first command in `vartest2` is executed, assigning 50 to `x`, the local variable `x` that exists in the subshell's environment will have the value 50 (see Figure 10.3) but the value of `x` in the parent shell will be unchanged.

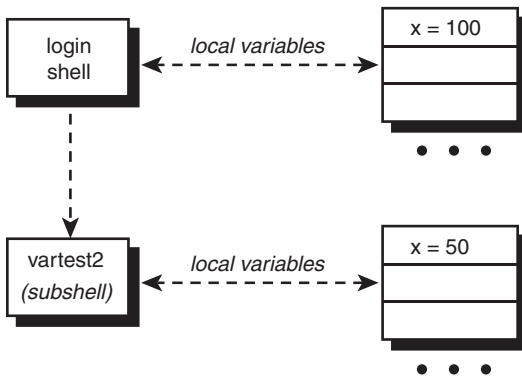

Figure 10.3 `vartest2` executes `x=50`

When `vartest2` finishes execution, the subshell goes away, *together with any variables assigned values by the program*.

This is less of a problem than it might seem. You just need to understand that the login shell environment and the environment of subshells and their shell programs are very different.

Exported Variables

There is a way to make the value of a variable known to a subshell, and that's by *exporting* it with the `export` command. The format of this command is simply

```
export variables
```

where *variables* is the list of variable names that you want exported. For any subshells that get executed subsequent to the `export` command, the value of the exported variables will be passed to the subshell.

Here's a program called `vartest3` to help illustrate the difference between local and exported variables:

```
$ cat vartest3
echo x = $x
echo y = $y
$
```

Assign values to the variables `x` and `y` in the login shell, and then run `vartest3`:

```
$ x=100
$ y=10
$ vartest3
x =
y =
$
```

`x` and `y` are both local variables, so their values aren't passed down to the subshell that runs `vartest3`. That's as expected.

But now let's export the variable `y` and try the program again:

```
$ export y           Make y known to subshells
$ vartest3
x =
y = 10
$
```

This time `vartest3` knew about `y` because it is an exported variable.

Conceptually, whenever a subshell is executed the exported variables get "copied down" to the subshell, whereas the local variables do not (see Figure 10.4).

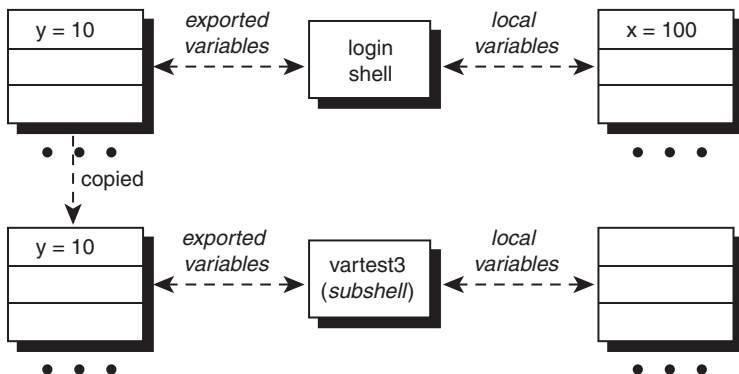

Figure 10.4 Execution of `vartest3`

Now it's time for another question: What do you think happens if a subshell changes the value of an exported variable? That is, will the parent shell know about it after the subshell has finished?

To answer this question, here's a program called `vartest4`:

```
$ cat vartest4
x=50
y=5
$
```

We'll assume that you haven't changed the values of `x` and `y`, and that `y` is still exported from the previous example.

```
$ vartest4
$ echo $x $y
100 10
$
```

The subshell couldn't change the value of either the local variable `x` (no surprise!) or the exported variable `y`, it merely changed its local subshell copy of `y` that was instantiated when it was executed (see Figure 10.5). Just as with local variables, when a subshell goes away, so do the values of the exported variables. In fact, once they get to the subshell, they *are* local variables.

That's why this is true: *There is no way to change the value of a variable in a parent shell from within a subshell.*

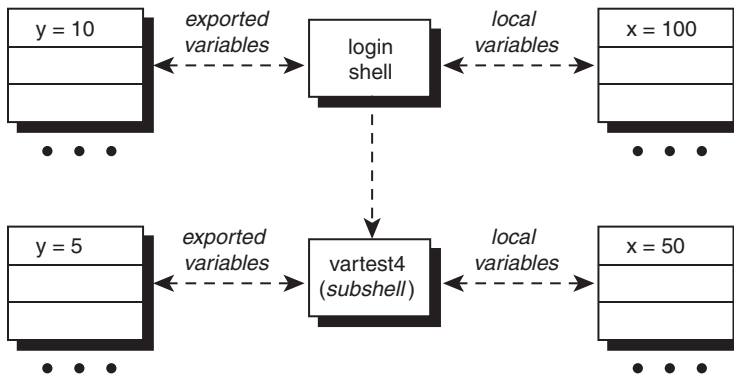

Figure 10.5 Execution of `vartest4`

In the case of a shell program invoking another shell program (for example, the `rolo` program calling the `lu` program), the process is repeated: the exported variables from the subshell are copied to the new subshell. These exported variables may have been exported from the login shell, or newly exported from within the subshell.

After a variable is exported, it remains exported to all subshells subsequently executed.

Consider a modified version of `vartest4`:

```
$ cat vartest4
x=50
y=5
z=1
export z
vartest5
$
```

and `vartest5`:

```
$ cat vartest5
echo x = $x
echo y = $y
echo z = $z
$
```

When `vartest4` gets executed, the exported variable `y` will be copied into the subshell's environment. `vartest4` sets the value of `x` to 50, changes the value of `y` to 5, and sets the value of `z` to 1. Then it exports `z` which makes the value of `z` accessible to any subsequent subshell.

`vartest5` is such a subshell and when it is executed the shell copies into its environment the exported variables from `vartest4`: `y` and `z`.

This explains the following output:

```
$ vartest4
x =
y = 5
z = 1
$
```

This entire process is depicted in Figure 10.6.

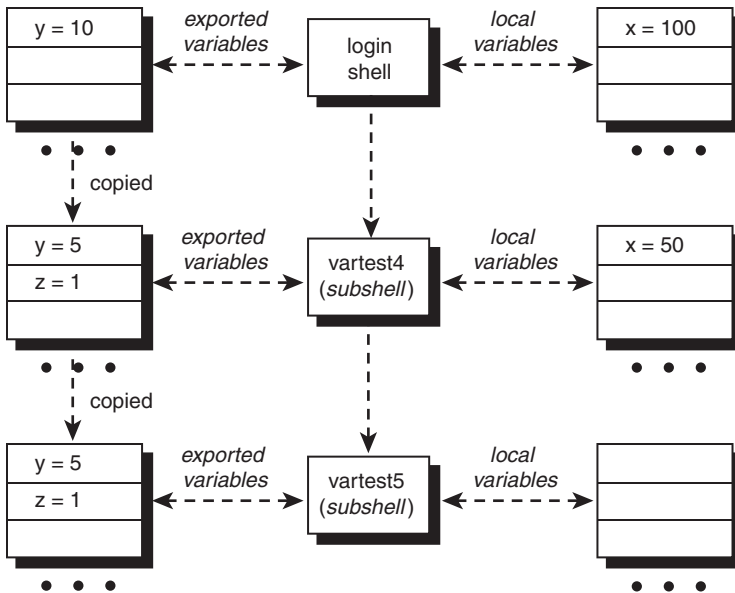

Figure 10.6 Subshell execution

To summarize the way local and exported variables work:

1. Any variable that is not exported is a local variable whose existence will not be known to subshells.
2. Exported variables and their values are copied into a subshell's environment, where they may be accessed and changed. However, such changes have no effect on the variables in the parent shell.
3. Exported variables retain this characteristic not only for directly spawned subshells, but also for subshells spawned by those subshells (and so on down the line).
4. A variable can be exported any time before or after it is assigned a value but takes on its value at the moment of export; subsequent changes aren't tracked.

```
export -p
```

If you type `export -p`, you'll get a list of the variables and their values exported by your shell:

```
$ export -p
export LOGNAME=steve
export PATH=/bin:/usr/bin:..
export TIMEOUT=600
export TZ=EST5EDT
export y=10
$
```

As you can see, there are actually lots of exported variables in a typical login shell. On the Mac, `export -p` produces a list of 22 variables. Note that in the example `y` shows up from our earlier `export` experimentation, along with other variables that were exported when you logged on and your login shell was started up.

But what are these all-capital-letter exported variables? Let's have a closer look.

PS1 and PS2

The sequence of characters that the shell uses as your command prompt are stored in the environment variable `PS1`. It turns out that you can change this to be anything you want and as soon as you change it, the new value will be used by the shell from that point on.

```
$ echo :$PS1:
:~$ :
$ PS1=="==> "
==> pwd
/users/steve
==> PS1="I await your next command, master: "
I await your next command, master: date
Wed Sep 18 14:46:28 EDT 2002
I await your next command, master: PS1="$ "
$                               Back to normal
```

Your secondary command prompt, used when a command requires more than a single line of input, defaults to `>` and is kept in the variable `PS2`. This too you can change to your heart's content:

```
$ echo :$PS2:
:> :
$ PS2="=====> "
$ for x in 1 2 3
=====> do
=====> echo $x
=====> done
1
2
3
$
```

Once you log off the system, all the changes will vanish, just like modifications to any other shell variables. If you change `PS1`, the shell will use the new value for the remainder of your login session. Next time you log in, however, you'll get the old prompt unless you save the new `PS1` value by adding it to your `.profile` file (discussed later in this chapter).

Tip

The `PS1` prompt has a language all its own with special sequences that produce the command count, current directory, time of day, and much more. Learn about it by reading the “Prompting” section of the `Bash` or `Sh` `man` page!

HOME

Your home directory is where you’re placed whenever you log on to the system. A special shell variable called `HOME` is also automatically set to this directory when you log on:

```
$ echo $HOME
/users/steve
$
```

This variable can be used by your programs to identify your home directory and is widely used by other programs in Unix for just this purpose. It’s also used by the `cd` command as the desired destination when you type `cd` with no arguments:

```
$ pwd                               Where am I?
/usr/src/lib/libc/port/stdio
$ cd
$ pwd
/users/steve                         There's no place like home
$
```

You can change your `HOME` variable to anything you want, but be warned that doing so may affect the operation of any programs that rely on it:

```
$ HOME=/users/steve/book            Change it
$ pwd
/users/steve
$ cd
$ pwd                                See what happened
/users/steve/book
$
```

You can change your `HOME`, but you really shouldn’t unless you’re prepared to have a lot of things go wonky rather quickly.

PATH

Let’s return to the `rolo` program from Chapter 9:

```
$ rolo Liz
Liz Stachiw      212-775-2298
$
```

To keep things neat and organized, the program was created in *steve's* `/bin` subdirectory, as shown:

```
$ pwd
/users/steve/bin
$
```

Change directory to anywhere else on the system:

```
$ cd Go home
$
```

And try to look up *Liz* in the phone book:

```
$ rolo Liz
sh: rolo: not found
$
```

Uh oh, that's not good. What happened?

Whenever you type in the name of a program, the shell searches a list of directories until it finds the requested program. When found, the program is started up. This list of directories to search for user commands is stored in a shell variable called `PATH` and it's automatically set when you log on. To see what it's set to at any point, use `echo`:

```
$ echo $PATH
/bin:/usr/bin:.
$
```

Chances are that your `PATH` has a somewhat different value, but don't worry about that—it's just variations in system configuration. The important thing to notice is that directories are separated by a colon (`:`) and that the shell searches them in order, left to right, to find requested commands or programs.

In the preceding example, three directories are listed: `/bin`, `/usr/bin`, and `.`, (which, you'll recall, stands for the current directory). So whenever you type in the name of a program, the shell searches the directories listed in `PATH` until it finds a matching executable file. Type in `rolo` and the shell first looks for `/bin/rolo`, then `/usr/bin/rolo`, then, finally, `./rolo` in the current directory. As soon as it finds a match the shell executes it, but if the shell doesn't find `rolo` in any of the directories specified in `PATH`, it issues a "not found" error.

To have the current directory searched before anything else, put the period at the start of `PATH`:

```
./bin:/usr/bin
```

Warning! For security reasons, it's not a good idea to have your current directory searched before the system ones.

This is to avoid a *Trojan horse* attack: Imagine that someone creates their own version of a command like `su` (which allows you to switch to root or superuser status by prompting for the admin password) in a directory then waits for another user to change to that directory and run the command. If `PATH` specifies that the current directory be searched first, then the modified version of `su` will be executed. The problem is, this version prompts for the password, emails

it to the malicious user, deletes itself, and prints out an innocuous error message. Reinvoked, password retyped, it all works fine and the administrator account has just been compromised without the user realizing anything has occurred! Sneaky, eh?

The period `.` for specifying the current directory is optional but useful as a visible reminder. For example, a `PATH` of

```
:/bin:/usr/bin
```

is equivalent to the previous one; however, throughout this text we'll specify the current directory with a period for clarity.

Worried about Trojan horses now? Don't fret, you can always override the search specified by `PATH` by specifying an explicit path to the program to be executed. For example, if you type

```
/bin/date
```

the shell goes directly to `/bin` to execute `date`. `PATH` in this case is ignored, as it is if you type in

```
../bin/lu
```

or

```
./rolo
```

This last case says to execute the program `rolo` in the current directory and is commonly used while developing shell programs because it lets programmers omit `.` from their `PATH`.

Now you understand why you couldn't execute `rolo` from your `HOME` directory: `/users/steve/bin` wasn't included in `PATH` so the shell couldn't find `rolo`. A simple matter to rectify: You can simply add this directory to `PATH`:

```
$ PATH=/bin:/usr/bin:/users/steve/bin:.
$
```

Now *any* program in `/users/steve/bin` can be executed regardless of your current directory in the file system:

```
$ pwd                               Where am I?
/users/steve
$ rolo Liz
grep: can't open phonebook
$
```

Oops. The shell finds `rolo` and executes it correctly, but the `grep` command can't find the phonebook data file.

Look more closely at the `rolo` program and you'll see that the `grep` error message must be coming from `lu`. Here's `lu`, as it exists currently:

```
$ cat /users/steve/bin/lu
#
# Look someone up in the phone book -- version 3
#
```

```

if [ "$#" -ne 1 ]
then
    echo "Incorrect number of arguments"
    echo "Usage: lu name"
    exit 1
fi

grep "$name" phonebook
$

```

`grep` is trying to open the `phonebook` file in the current directory—which is `/users/steve`—and that’s the problem: where the program is being executed from has no relation to the directory in which the program and its data file reside.

`PATH` only specifies the directories to be searched for programs invoked on the command line, and not for any other types of files. So `phonebook` must be precisely located for `lu` to make it more useful.

There are several ways to fix this problem, which also exists with the `rem` and `add` programs. One approach is to have the `lu` program change directory to `/users/steve/bin` before it invokes `grep`. That way, `grep` finds `phonebook` because it exists in the new current directory:

```

...
cd /users/steve/bin
grep "$1" phonebook

```

This approach is a good one to take when you’re doing a lot of work with different files in a particular directory. Simply `cd` to the directory first and then you can directly reference all the files you need.

A second, more common approach is to list a full path to `phonebook` in the `grep` command:

```

...
grep "$1" /users/steve/bin/phonebook

```

Suppose that you want to let others use your `rolo` program (and associated `lu`, `add`, and `rem` helper programs). You can give them each their own copy, but then you’ll have several copies on the system and what happens if you make a small change? Are you going to update all their copies as well? Tedious.

A better solution is to have a single copy of `rolo` but to give other users access to it.

The problem should be obvious at this point: If you change all the references of `phonebook` to explicitly reference *your* phone book, everyone else will be using *your* phone book too. A smarter way to solve the problem is to require that everyone have a `phonebook` file in their home directory and refer to the file as `$HOME/phonebook`.

To use a very common shell programming convention, define a variable inside `rolo` called `PHONEBOOK` and set it to the multi-user friendly value `$HOME/phonebook`. If you export this variable, `lu`, `rem`, and `add` (which are executed as subshells by `rolo`) can also use the value of `PHONEBOOK` to reference the individual user’s version of the file.

One advantage of this approach is that if you change the location of the `phonebook` file, all you'll have to do is change this one variable in `rolo`; the other three programs will continue to work without a glitch.

With that in mind, here is the new `rolo` program, followed by modified `lu`, `add`, and `rem` programs.

```
$ cd /users/steve/bin
$ cat rolo
#
# rolo - rolodex program to look up, add, and
#       remove people from the phone book
#
#
# Set PHONEBOOK to point to the phone book file
# and export it so other progs know about it
#

PHONEBOOK=$HOME/phonebook
export PHONEBOOK

if [ ! -f "$PHONEBOOK" ] ; then
    echo "No phone book file in $HOME!"
    exit 1
fi

#
# If arguments are supplied, then do a lookup
#

if [ "$#" -ne 0 ] ; then
    lu "$@"
    exit
fi

validchoice=""          # set it null

#
# Loop until a valid selection is made
#

until [ -n "$validchoice" ]
do
    #
    # Display menu
    #
```

```

    echo '
    Would you like to:

    1. Look someone up
    2. Add someone to the phone book
    3. Remove someone from the phone book

Please select one of the above (1-3): \c'

#
# Read and process selection
#

read choice
echo

case "$choice"
in
    1) echo "Enter name to look up: \c"
        read name
        lu "$name"
        validchoice=TRUE;;
    2) echo "Enter name to be added: \c"
        read name
        echo "Enter number: \c"
        read number
        add "$name" "$number"
        validchoice=TRUE;;
    3) echo "Enter name to be removed: \c"
        read name
        rem "$name"
        validchoice=TRUE;;
    *) echo "Bad choice";;
esac

done
$ cat add
#
# Program to add someone to the phone book file
#

if [ "$#" -ne 2 ] ;then
    echo "Incorrect number of arguments"
    echo "Usage: add name number"
    exit 1
fi

echo "$1      $2" >> $PHONEBOOK

```

```

sort -o $PHONEBOOK $PHONEBOOK
$ cat lu
#
# Look someone up in the phone book
#

if [ "$#" -ne 1 ] ; then
    echo "Incorrect number of arguments"
    echo "Usage: lu name"
    exit 1
fi

name=$1
grep "$name" $PHONEBOOK

if [ $? -ne 0 ] ; then
    echo "I couldn't find $name in the phone book"
fi
$ cat rem
#
# Remove someone from the phone book
#

if [ "$#" -ne 1 ] ; then
    echo "Incorrect number of arguments"
    echo "Usage: rem name"
    exit 1
fi

name=$1

#
# Find number of matching entries
#

matches=$(grep "$name" $PHONEBOOK | wc -l)

#
# If more than one match, issue message, else remove it
#

if [ "$matches" -gt 1 ] ; then
    echo "More than one match; please qualify further"
elif [ "$matches" -eq 1 ] ; then
    grep -v "$name" $PHONEBOOK > /tmp/phonebook$$
    mv /tmp/phonebook$$ $PHONEBOOK
else

```

```

        echo "I couldn't find $name in the phone book"
    fi
$

```

Note that we added one more tweak: In an effort to be more user-friendly, a test was added to the end of `lu` to see whether the `grep` succeeded or not, and a fail message is now displayed if the search doesn't produce any results.

Now to test it:

```

$ cd Return home
$ rolo Liz Quick lookup
No phonebook file in /users/steve! Forgot to move it
$ mv /users/steve/bin/phonebook .
$ rolo Liz Try again
Liz Stachiw      212-775-2298
$ rolo Try menu selection
    Would you like to:

    1. Look someone up
    2. Add someone to the phone book
    3. Remove someone from the phone book

```

```

Please select one of the above (1-3): 2

```

```

Enter name to be added: Teri Zak
Enter number: 201-393-6000
$ rolo Teri
Teri Zak      201-393-6000
$

```

`rolo`, `lu`, and `add` are working fine. `rem` should also be tested to make sure that it's okay as well.

If you still want to run `lu`, `rem`, or `add` standalone, you can do it provided that you first define `PHONEBOOK` and export it:

```

$ PHONEBOOK=$HOME/phonebook
$ export PHONEBOOK
$ lu Harmon
I couldn't find Harmon in the phone book
$

```

If you do intend to run these programs standalone, you'd better put checks in the individual programs to ensure that `PHONEBOOK` is set to the correct value.

Your Current Directory

Your current directory is also part of your shell environment. Consider this small shell program called `cdtest`:

```
$ cat cdtest
cd /users/steve/bin
pwd
$
```

The program uses `cd` to move to `/users/steve/bin` and then invokes `pwd` to verify that the change was made. Let's run it:

```
$ pwd                                Get my bearings
/users/steve
$ cdtest
/users/steve/bin
$
```

Now for the \$64,000 question: If you invoke `pwd`, will you be in `/users/steve` or `/users/steve/bin`?

```
$ pwd
/users/steve
$
```

It turns out that the `cd` in `cdtest` had no effect on your current directory. Because the current directory is part of the environment, when a `cd` is executed from a subshell, it only affects the directory of the subshell. *There is no way to change the current directory of a parent shell from a subshell.*

When `cd` is invoked, it changes your current directory and also sets the `PWD` variable to the full pathname of the new current directory. As a result, the command

```
echo $PWD
```

produces the same output as the `pwd` command:

```
$ pwd
/users/steve
$ echo $PWD
/users/steve
$ cd bin
$ echo $PWD
/users/steve/bin
$
```

`cd` also sets `OLDPWD` to the full pathname of the previous current directory, which can be useful in certain situations too.

CDPATH

The `CDPATH` variable works like the `PATH` variable: it specifies a list of directories to be searched by the shell whenever you execute a `cd` command. This search is done only if the specified directory is not given by a full pathname and if `CDPATH` is not null. If you type in

```
cd /users/steve
```

the shell changes your directory directly to `/users/steve`; but if you type

```
cd memos
```

the shell looks at your `CDPATH` variable to find the `memos` directory. And if your `CDPATH` looks like this:

```
$ echo $CDPATH
.: /users/steve: /users/steve/docs
$
```

the shell first looks in your current directory for a `memos` directory, and if not found then looks in `/users/steve` for a `memos` directory, and if not found there tries `/users/steve/docs` in a last ditch effort to find the directory. If the directory that it finds is not relative to your current one, the `cd` command prints the full path to the directory to let you know where it's taking you:

```
$ cd /users/steve
$ cd memos
/users/steve/docs/memos
$ cd bin
/users/steve/bin
$ pwd
/users/steve/bin
$
```

Like the `PATH` variable, use of the period for specifying the current directory is optional, so

```
./users/steve: /users/steve/docs
```

is equivalent to

```
.: /users/steve: /users/steve/docs
```

Judicious use of the `CDPATH` variable can save you a lot of typing, especially if your directory hierarchy is fairly deep and you find yourself frequently moving around in it (or if you're frequently moving into other directory hierarchies as well).

Unlike `PATH`, you'll probably want to put your current directory first in the `CDPATH` list. This gives you the most natural use of `CDPATH`; if the current directory isn't listed first, you may end up in an unexpected directory!

Oh, and one more thing: `CDPATH` isn't set when you log in; you need to explicitly set it to the sequences of directories you'd like the shell to use when searching for the specified name.

More on Subshells

You know that a subshell can't change the value of a variable in a parent shell, nor can it change its current directory. Suppose that you want to write a program to set values for some variables that you like to use whenever you log on. For example, assume that you have the following file called `vars`:

```
$ cat vars
BOOK=/users/steve/book
UUPUB=/usr/spool/uucppublic
DOCS=/users/steve/docs/memos
DB=/usr2/data
$
```

If you invoke `vars`, the values assigned to these variables will essentially vanish after the program has finished executing because `vars` is run in a subshell:

```
$ vars
$ echo $BOOK

$
```

No surprise there.

The `.` Command

To address this dilemma, there's a built-in shell command called `.` (pronounced "dot") whose general format is

```
. file
```

and whose purpose is to execute the contents of *file* in the *current* shell. That is, commands from *file* are executed by the current shell just as if they were typed, not within a subshell. The shell uses your `PATH` variable to find *file*, just like it does when executing other programs.

```
$ . vars                                Execute vars in the current shell
$ echo $BOOK
/users/steve/book                       Hoorah!
$
```

Because a subshell isn't spawned to execute the program, any variable that gets assigned a value is retained even after the program completes.

If you have a program called `db` that has the following commands:

```
$ cat db
DATA=/usr2/data
RPTS=$DATA/rpts
BIN=$DATA/bin

cd $DATA
$
```

executing `db` with the “dot” command will do something interesting:

```
$ pwd
/users/steve
$ . db
$
```

This time the shell program defines the three variables `DATA`, `RPTS`, and `BIN` in the current shell and moves to the `$DATA` directory.

```
$ pwd
/usr2/data
$
```

If you work on multiple projects, you can create programs like `db` to customize your environment as needed. In that program, you can also include definitions for other variables, change prompts, and more. For example, you might want to change your `PS1` prompt to `DB`—to let you know that your database variables have been set up. You could change your `PATH` to include a directory that has programs related to the database and your `CDPATH` so that the related directories will be easily accessed with the `cd` command.

On the other hand, if you make these sorts of changes, you might want to execute `db` in a subshell rather than the current shell because doing the latter leaves all the modified variables around after you’ve finished your work.

The best solution is to start a *new* shell from inside the subshell, with all the modified variables and updated environment settings. Then, when you’re finished working, you can “log out” the new shell by pressing `Ctrl+d`.

Let’s take a look at how this works with a new version of `db`:

```
$ cat db
#
# Set up and export variables related to the data base
#

HOME=/usr2/data
BIN=$HOME/bin
RPTS=$HOME/rpts
DATA=$HOME/rawdata

PATH=$PATH$BIN
CDPATH=:$HOME:$RPTS

PS1="DB: "

export HOME BIN RPTS DATA PATH CDPATH PS1

#
```

```
# Start up a new shell
#
```

```
/bin/sh
$
```

The `HOME` directory is set to `/usr2/data`, and then the variables `BIN`, `RPTS`, and `DATA` are defined relative to this `HOME` (a good idea in case you ever have to move the directory structure somewhere else: all you'd have to change in the program is the variable `HOME`).

Next, `PATH` is modified to include the database `bin` directory and the `CDPATH` variable is set to search the current directory, the `HOME` directory, and the `RPTS` directory (which presumably contains subdirectories).

After exporting these variables, the standard shell, `/bin/sh`, is invoked. From that point on, this new shell processes any user-entered commands until either the user types `exit` or uses the `Ctrl+d` sequence. Upon `exit`, control returns to `db`, which in turn returns control to your login shell.

<pre>\$ db DB: echo \$HOME /usr2/data DB: cd rpts /usr2/data/rpts DB: ps PID TTY TIME COMMAND 123 13 0:40 sh 761 13 0:01 sh 765 13 0:01 sh 769 13 0:03 ps DB: exit \$ echo \$HOME /users/steve \$</pre>	<p><i>Run it</i></p> <p><i>Try out CDPATH</i></p> <p><i>It works</i></p> <p><i>See what processes are running</i></p> <p><i>Your login shell</i></p> <p><i>Subshell running db</i></p> <p><i>New shell run from db</i></p> <p><i>Done for now</i></p> <p><i>Back to normal</i></p>
---	--

The execution of `db` is depicted in Figure 10.7 (where we've shown only the exported variables of interest for simplicity's sake, not all that exist in the environment).

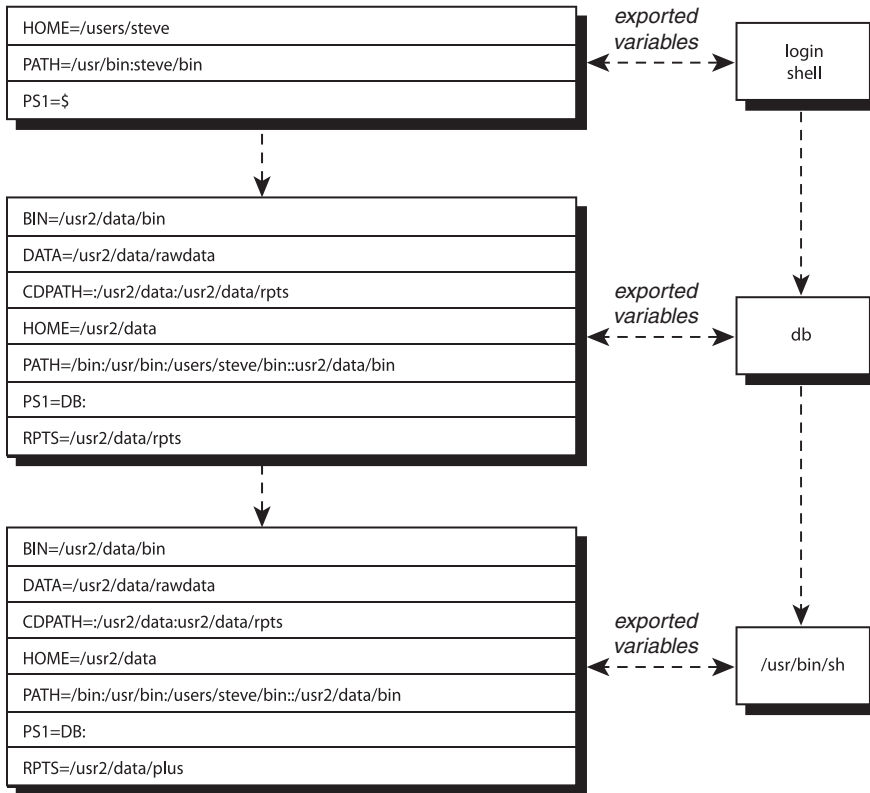
Figure 10.7 Executing `db`

The `exec` Command

Within the `db` program, once the shell process completed, you were done with everything, as demonstrated by the fact that no commands followed `/bin/sh` in the program. Instead of having `db` wait around for the subshell to finish, you can use the `exec` command to *replace the current program* (`db`) *with the new one* (`/bin/sh`).

The general format of `exec` is

```
exec program
```

Because the `exec`'ed program replaces the current one, there's one less process hanging around, which helps the system run quickly. The startup time of an `exec`'ed program is quicker too, due to how Unix systems execute processes.

To use `exec` in the `db` program, you simply replace the last line with

```
exec /bin/sh
```

After this statement is executed, `db` will be replaced by `/bin/sh`. This means that it would now be pointless to have any commands follow the `exec` because they'll never be executed.

`exec` can also be used to close standard input and reopen it with any file that you want to read. To change standard input to `infile`, for example, use the `exec` command in the form

```
exec < infile
```

Any commands that subsequently read data from standard input will read from `infile`.

Redirection of standard output is done similarly. The command

```
exec > report
```

redirects all subsequent output written to standard output to the file `report`. Note in both of the previous examples that `exec` is not used to start up execution of a new program, just used to reassign standard input or standard output.

If you use `exec` to reassign standard input and later want to reassign it someplace else, you can simply invoke `exec` again. To reassign standard input back to the terminal, you would write

```
exec < /dev/tty
```

The same concept also applies to reassignment of standard output.

The (...) and { ...; } Constructs

Sometimes you want to group a set of commands together. For example, you may want to push a `sort` followed by your `plotdata` program into the background. Not connected with a pipe; just two commands one after the other.

It turns out that you can group a set of commands together by enclosing them in parentheses or braces. The first form causes the commands to be executed by a subshell, the latter form by the current shell.

Here are some examples to illustrate how they work:

```
$ x=50
$ (x=100)                               Execute this in a subshell
$ echo $x
50                                       Didn't change
$ { x=100; }                             Execute this in the current shell
$ echo $x
100
$ pwd                                    Where am I?
/users/steve
$ (cd bin; ls)                           Change to bin and do an ls
add
greetings
lu
number
```

```

phonebook
rem
rolo
$ pwd
/users/steve
$ { cd bin; }
$ pwd
/users/steve/bin
$

```

No change
This should change me

If the commands enclosed in the braces are all going to be on the same line, a space must follow the left brace, and a semicolon must appear after the last command. Look closely at the statement above—`{ cd bin; }`—for an example.

Parentheses work differently. As the example

```
(cd bin; ls)
```

demonstrates, parentheses are useful for executing commands without affecting the current environment.

You can also use them for other purposes like pushing a set of commands into the background:

```

$ (sort 2016data -0 2016data; plotdata 2016data) &
[1] 3421
$

```

The parentheses group the `sort` and `plotdata` commands together so that they can be sent to the background with their order of execution preserved.

Input and output can also be piped to and from these constructs, and I/O can be redirected too, which makes them darn helpful to shell programmers.

In the next example, a dot-prefaced `nroff` command—`.ls 2`—is effectively prepended to the beginning of the file `memo` before being sent to `nroff` for processing.

```
$ { echo ".ls 2"; cat memo; } | nroff -Tlp | lp
```

In the command sequence

```
$ { prog1; prog2; prog3; } 2> errors
```

all messages written to standard error by the three programs are collected into the file `errors`.

As a final example, let's return to the `waitFor` program from Chapter 8. As you'll recall, this program periodically checks for a user logging on to the system. You'll recall that it would be nice if the program could somehow automatically "send itself" to the background. Now you know how to do it: Simply enclose the `until` loop and the commands that follow within parentheses and send the entire grouping into the background:

```

$ cat waitFor
#
# Wait until a specified user logs on -- version 4
#

```

```

# Set up default values
mailopt=FALSE
interval=60

# process command options

while getopts mt: option
do
    case "$option"
    in
        m)    mailopt=TRUE;;
        t)    interval=$OPTARG;;
        \?)   echo "Usage: mon [-m] [-t n] user"
              echo " -m means to be informed by mail"
              echo " -t means check every n secs."
              exit 1;;
    esac
done

# Make sure a user name was specified

if [ "$OPTARG" -gt "$#" ] ; then
    echo "Missing user name!"
    exit 2
fi

shiftcount=$(( OPTIND - 1 ))
shift $shiftcount
user=$1

#
# Send everything that follows into the background
#
(
    #
    # Check for user logging on
    #

    until who | grep "^$user " > /dev/null
    do
        sleep $interval
    done

    #
    # When we reach this point, the user has logged on
    #

```

```

if [ "$mailopt" = FALSE ] ; then
    echo "$user has logged on"
else
    runner=$(who am i | cut -c1-8)
    echo "$user has logged on" | mail $runner
fi
) &
$

```

The entire program could have been enclosed in parentheses, but we decided to do the argument checking and parsing prior to moving the program into the background.

```

$ waitfor fred
$
Prompt comes back so you can continue working
...
fred has logged on

```

Note that a process ID is not printed by the shell when a command is sent to the background within a shell program.

Another Way to Pass Variables to a Subshell

If you want to send the value of a variable to a subshell, there's another way to do it besides exporting the variable. On the command line, precede the command with the assignment of one or more variables. For example,

```
DBHOME=/uxn2/data DBID=452 dbrun
```

places the variables `DBHOME` and `DBID`, and their indicated values, into the environment of `dbrun`, then `dbrun` gets executed. These variables will not be known to the current shell, however, because they're only created for the execution of `dbrun`.

In fact, the preceding command behaves identically to typing

```
(DBHOME=/uxn2/data; DBID=452; export DBHOME DBID; dbrun)
```

Here's a short example:

```

$ cat foo1
echo :$x:
foo2
$ cat foo2
echo :$x:
$ foo1
::
::
x not known to foo1 or foo2
Try it this way
$ x=100 foo1
:100:
:100:
x is known to foo1
and to its subshells
$ echo :$x:
::
Still not known to current shell
$

```

Variables defined this way otherwise behave as normal exported variables to the subshell but don't exist for the invoking shell once that line of code is executed.

Your .profile File

In Chapter 2 you learned about the login sequence completed before the shell displays your command prompt, ready for you to type your first command. Before the prompt, the login shell looks for and reads two special files on the system.

The first is `/etc/profile`, set up by the system administrator. It generally checks to see whether you have mail (it's where the "You have mail" message comes from), sets your default file creation mask (your `umask`), establishes a default `PATH`, and anything else that the administrator wants to have happen whenever a user logs in.

More interestingly, the second file that gets automatically executed is `.profile` in your home directory. Most Unix systems set up a default `.profile` file when the account is created, so let's start by seeing what's in it:

```
$ cat $HOME/.profile
PATH="/bin:/usr/bin:/usr/sbin:."
export PATH
$
```

This is a pretty modest `.profile` that simply sets the `PATH` and exports it.

You can change your `.profile` file to include any commands that you want executed whenever you log in, including indicating which directory you start out in, a check of who's logged in, and the instantiation of any system aliases you prefer. You can even put commands in your `.profile` that override settings (usually environment variables) established in `/etc/profile`.

Since we've said you can change your current working directory within the `.profile`, it should be no surprise that the login shell actually executes these files as if you typed in

```
$ . /etc/profile
$ . .profile
$
```

as soon as you logged in. This also means that changes to your environment made within the `.profile` remain until you log out of the shell.

Most Unix users dabble with their `.profile` to change lots of aspects of their command line environment. For example, here's a sample `.profile` that sets `PATH` to include your own `bin`, sets `CDPATH`, changes the primary and secondary command prompts, changes the erase character to a backspace (`Ctrl+h`) with the `stty` command, and prints a friendly message using the `greetings` program from Chapter 7:

```
$ cat $HOME/.profile
PATH=/bin:/usr/bin:/usr/sbin:$HOME/bin:..
CDPATH=.:$HOME:$HOME/misc:$HOME/documents
```

```

PS1="=> "
PS2="====> "

export PATH CDPATH PS1 PS2

stty echoe erase CTRL-h

echo
greetings
$

```

Here's what a login sequence would look like with this `.profile`:

```

login: steve
Password:

```

```

Good morning
=>

```

```

Output from greetings
New PS1

```

The TERM Variable

Though many of the programs in Unix are command-line based (like `ls` and `echo`), there are a number of full-screen commands (like the `vi` editor) that require a detailed knowledge of your terminal settings and capabilities. The environment variable that holds that information is `TERM` and usually it's nothing you need to worry about: your Terminal or SSH program usually sets it automatically to be the optimal value for things to work seamlessly.

However, some old-school users might find that `TERM` needs to have a specific value like `ansi` or `vt100` or `xterm` for the full-screen programs to behave properly. In those instances, setting the value within `.profile` is recommended.

You can even prompt for a `TERM` value during the login sequence by having a simple code block like this:

```

echo "What terminal are you using (xterm is the default)? \c"
read TERM
if [ -z "$TERM" ]
then
    TERM=xterm
fi
export TERM

```

Based on the terminal type entered, you may also want to do things such as set up the function keys or the tabs on the terminal.

Even if you always use the same terminal type, you should set the `TERM` variable in your `.profile` file.

As a point of interest, Mac OS X and Ubuntu Linux users will find that the `TERM` type for the Terminal program is `xterm-256color`, and Solaris Unix users have `vt100` as their default `TERM`. Many third party `telnet/SSH` (terminal) programs use `ansi` as their `TERM` value.

The TZ Variable

The `TZ` variable is used by the `date` command and some Standard C library functions to determine the current time zone. Indeed, since users can log in remotely through the Internet, it's entirely possible that different users on a system are in different time zones. The simplest setting for `TZ` is a time zone name of three or more alphabetic characters followed by a number that specifies the number of hours that must be added to the local time to arrive at *Coordinated Universal Time*, also known as Greenwich Mean Time. This number can be positive (local time zone is west of 0 longitude) or negative (local time zone is east of 0 longitude). For example, Eastern Standard Time can be specified as

```
TZ=EST5
```

The `date` command calculates the correct time based on this information and uses the time zone name in its output, as necessary:

```
$ TZ=EST5 date
Wed Feb 17 15:24:09 EST 2016
$ TZ=xyz3 date
Wed Feb 17 17:46:28 xyz 2016
$
```

A second time zone name can follow the number and if this is specified, daylight saving time is assumed to apply (`date` then automatically adjusts the time when daylight saving is in effect) and is assumed to be one hour ahead of the standard time. If a number follows the daylight saving time zone name, this value is used to compute the daylight saving time from the Coordinated Universal Time in the same way as the number previously described.

Most commonly, you'll see a time zone specified as `EST5EDT` or `MST7MDT`, though since some areas of the world don't actually switch for DST, that can be specified too, of course.

The `TZ` variable is usually set in either the `/etc/profile` file or your `.profile` file. If not set, an implementation-specific default time zone is used, typically Coordinated Universal Time.

Also note that on many modern Linux systems the time zone can be set by specifying a geographic region, so

```
TZ="America/Tijuana" date
```

will show the current time in Tijuana, Mexico.

This page intentionally left blank

More on Parameters

In this chapter, you'll learn more about variables and parameters. Technically, parameters include the arguments passed to a program (the *positional* parameters), the special shell variables such as `$#` and `$?`, and ordinary variables, also known as *keyword* parameters.

Positional parameters cannot be assigned values directly but they can be reassigned values with the `set` command. As you know, variables are assigned values simply by writing

```
variable=value
```

The format is a bit more general than that shown, actually, because you can assign several variables at once using the format

```
variable=value variable=value ...
```

The following example illustrates:

```
$ x=100 y=200 z=50
$ echo $x $y $z
100 200 50
$
```

Parameter Substitution

In the simplest form, to have the value of a parameter substituted, precede the parameter with a dollar sign, as in `$i` or `$9`.

```
${parameter}
```

If there's a potential conflict caused by the characters that follow the parameter name, you can enclose the name inside curly braces, as in

```
mv $file ${file}x
```

This command would add an `x` to the end of the filename specified by `$file`. It could not be written as

```
mv $file $filex
```

because the shell would try to substitute the value of a variable named `filex` for the second argument, not `file` plus the letter `x`.

As mentioned in Chapter 6, to access positional parameters 10 and above, you also must enclose the number inside curly braces using the same notational format: `${11}`.

But it turns out that once you wrap a variable name with curly braces, there's quite a bit more you can do...

`${parameter:-value}`

This construct says to use the value of *parameter* if it is not null, and to substitute *value* otherwise. For example, in the command line

```
echo Using editor ${EDITOR:-/bin/vi}
```

the shell will use the value of `EDITOR` if it's not null and the value `/bin/vi` otherwise. It has the same effect as writing

```
if [ -n "$EDITOR" ]
then
    echo Using editor $EDITOR
else
    echo Using editor /bin/vi
fi
```

The command line

```
${EDITOR:-/bin/ed} /tmp/edfile
```

starts up the program stored in the variable `EDITOR` (presumably a text editor), or `/bin/ed` if `EDITOR` is null.

Important to note is that this doesn't change the value of the variable, so even after the above statement, if `EDITOR` started out as null, it would continue to have the null value.

Here's a simple demonstration of this construct:

```
$ EDITOR=/bin/ed
$ echo ${EDITOR:-/bin/vi}
/bin/ed
$ EDITOR=           Set it null
$ echo ${EDITOR:-/bin/vi}
/bin/vi
$
```

```
${parameter:=value}
```

This version is similar to the previous, but if *parameter* is null not only is *value* used, but it is also assigned to *parameter* as well (note the = in the construct). You can't assign values to positional parameters this way, however, so that means that *parameter* can't be a number.

A typical use of this construct would be in testing to see whether an exported variable has been set and, if not, assigning it a default value:

```
${PHONEBOOK:=${HOME}/phonebook}
```

This says that if `PHONEBOOK` already has an assigned value, leave it alone, otherwise set it to `HOME/phonebook`.

Note that the preceding example could not stand alone as a command because after the substitution is performed the shell would attempt to execute the result:

```
$ PHONEBOOK=
$ ${PHONEBOOK:=${HOME}/phonebook}
sh: /users/steve/phonebook: cannot execute
$
```

To use this construct as a stand-alone command, the null command can be employed. If you write

```
: ${PHONEBOOK:=${HOME}/phonebook}
```

the shell still does the substitution (it evaluates the rest of the command line), yet executes nothing (the null command).

```
$ PHONEBOOK=
$ : ${PHONEBOOK:=${HOME}/phonebook}
$ echo $PHONEBOOK                               See if it got assigned
/users/steve/phonebook
$ : ${PHONEBOOK:=foobar}                         Shouldn't change it
$ echo $PHONEBOOK
/users/steve/phonebook                           It didn't
$
```

Just as commonly seen, however, are shell programs that use the `:=` notation on the first reference to the variable in a conditional or `echo` statement. Same effect, but without the null command.

```
${parameter:?value}
```

If *parameter* is not null, the shell substitutes its value; otherwise, the shell writes *value* to standard error and then exits (don't worry—if it's done from your login shell, you won't be logged off). If *value* is omitted, the shell writes the default error message

```
prog: parameter: parameter null or not set
```

Here's an example:

```
$ PHONEBOOK=
$ : ${PHONEBOOK:? "No PHONEBOOK file"}
No PHONEBOOK file
$ : ${PHONEBOOK:?}           Don't give a value
sh: PHONEBOOK: parameter null or not set
$
```

With this construct, you can easily check to see whether variables needed by a program are all set and not null:

```
: ${TOOLS:?} ${EXPTOOLS:?} ${TOOLBIN:?}
```

`${parameter:+value}`

This one substitutes *value* if *parameter* is not null; otherwise, it substitutes nothing. It's the opposite of `:-`, of course.

```
$ traceopt=T
$ echo options: ${traceopt:+ "trace mode"}
options: trace mode
$ traceopt=
$ echo options: ${traceopt:+ "trace mode"}
options:
$
```

The *value* part for any of the constructs in this section can be a command substitution because it's executed only if its value is required. This can get a bit complicated too. Consider this:

```
WORKDIR=${DBDIR:-$(pwd)}
```

Here `WORKDIR` is assigned the value of `DBDIR` if it's not null, or the `pwd` command is executed and the result assigned to `WORKDIR`. `pwd` is executed *only if* `DBDIR` is null.

Pattern Matching Constructs

The POSIX shell offers four parameter substitution constructs that perform pattern matching. Some really old shells do not support this feature, but it's unlikely you'll encounter one of them if you're on a modern Unix, Linux, or Mac system.

The construct takes two arguments: a variable name (or parameter number) and a pattern. The shell searches through the contents of the specified variable to match the supplied pattern. If matched, the shell uses the value of the variable on the command line, *with the matching portion of the pattern deleted*. If the pattern is not matched, the entire contents of the variable are used on the command line. In both cases, the contents of the variable remain unchanged.

The term *pattern* is used here because the shell allows you to use the same pattern matching characters that it accepts in filename substitution and `case` values: `*` to match zero or more characters, `?` to match any single character, `[...]` to match any single character from the specified set, and `[!...]` to match any single character not in the specified set.

When you write the construct

```
${variable%pattern}
```

the shell looks inside *variable* to see whether it *ends* with the specified *pattern*. If it does, the contents of *variable* are used, with the shortest matching *pattern* removed from the right.

If you use the construct

```
${variable%%pattern}
```

the shell once again looks inside *variable* to see whether it ends with *pattern*. This time, however, it removes the *longest* matching pattern from the right. This is relevant only if the *** is used in *pattern*. Otherwise, the *%* and *%%* behave the same way.

The *#* is used in a similar way to force the pattern matching to start from the left rather than the right. So, the construct.

```
${variable#pattern}
```

tells the shell to use the value of *variable* on the command line, with *pattern* removed from the left.

Finally, the shell construct

```
${variable##pattern}
```

works like the *#* form, except that the longest occurrence of *pattern* is removed from the left.

Remember that in all four cases, no changes are made to the variable itself. You are affecting only what gets used on the command line. Also, remember that the pattern matches are *anchored*. In the case of the *%* and *%%* constructs, the values of the variable must *end* with the specified pattern; in the case of the *#* and *##* constructs, the variable must *begin* with it.

Here are some simple examples to show how these constructs work:

```
$ var=testcase
$ echo $var
testcase
$ echo ${var%e}           Remove e from right
testcas
$ echo $var              Variable is unchanged
testcase
$ echo ${var%s*e}        Remove smallest match from right
testca
$ echo ${var%%s*e}      Remove longest match
te
$ echo ${var#?e}        Remove smallest match from left
stcase
$ echo ${var##s}        Remove smallest match from left
tcase
$ echo ${var###s}       Remove longest match from left
```

```
e
$ echo ${var#test}           Remove test from left
case
$ echo ${var#teas}         No match
testcase
$
```

There are many practical uses for these constructs. For example, the following tests to see whether the filename stored inside the variable `file` ends in the two characters `.o`:

```
if [ ${file%.o} != $file ] ; then
    # file ends in .o
    ...
fi
```

As another example, here's a shell program that works just like the Unix system's `basename` command:

```
$ cat mybasename
echo ${1##*/}
$
```

The program displays its argument with all the characters up to the last `/` removed:

```
$ mybasename /usr/spool/uucppublic
uucppublic
$ mybasename $HOME
steve
$ mybasename memos
memos
$
```

But wait, there are more constructs.

`${#variable}`

Need to figure out how many characters are stored in a variable? That's just what this construct offers:

```
$ text='The shell'
$ echo ${#text}
9
$
```

Tip

Each of the parameter constructs described in this chapter is summarized in Appendix A, Table A.3.

The \$0 Variable

Whenever you execute a shell program, the shell automatically stores the name of the program inside the special variable \$0. This can be helpful in a number of situations, including when you have a program accessible through different command names through hard links in the file system. It lets you programmatically figure out which one was executed.

It's more commonly used for displaying error messages because it is based on the actual program file name, not whatever's hardcoded in the program itself. If the name of the program is referenced by \$0, renaming the program will update the message without requiring the program to be edited:

```
$ cat lu
#
# Look someone up in the phone book
#

if [ "$#" -ne 1 ] ; then
    echo "Incorrect number of arguments"
    echo "Usage: $0 name"
    exit 1
fi

name=$1
grep "$name" $PHONEBOOK

if [ $? -ne 0 ] ; then
    echo "I couldn't find $name in the phone book"
fi
$ PHONEBOOK=$HOME/phonebook
$ export PHONEBOOK
$ lu Teri
Teri Zak      201-393-6000
$ lu Teri Zak
Incorrect number of arguments
Usage: lu name
$ mv lu lookup
Rename it
$ lookup Teri Zak
See what happens now
Incorrect number of arguments
Usage: lookup name
$
```

Some Unix systems will automatically make \$0 a full pathname including directories, which can lead to some clunky error and usage messages. In that instance, use \$(basename \$0) or utilize the trick from earlier to chop out the path name:

```
${0##*/}
```

The set Command

The shell's `set` command also serves two purposes: it's used both to set various shell options and to reassign the positional parameters `$1`, `$2`, and so on... .

The `-x` Option

Earlier, in Chapter 7 we briefly looked at using `sh -x ctype` as a way to help debug problems in a shell program, but the `set` command lets you actually turn on and off trace mode for specific portions of your program.

Within a program, the statement

```
set -x
```

enables trace mode, which means all subsequently executed commands will be printed to standard error by the shell, after filename, variable, and command substitution, as well as I/O redirection have been performed. The traced commands are preceded by plus signs.

```
$ x=*
$ set -x                               Set command trace option
$ echo $x
+ echo add greetings lu rem rolo
add greetings lu rem rolo
$ cmd=wc
+ cmd=wc
$ ls | $cmd -l
+ ls
+ wc -l
      5
$
```

You can turn off trace mode at any time simply by executing `set` with the `+x` option:

```
$ set +x
+ set +x
$ ls | wc -l
      5                               Back to normal
$
```

Note that the trace option is *not* passed down to subshells. But you can trace a subshell's execution either by invoking the program with the `sh -x` option followed by the name of the program, as in

```
sh -x rolo
```

or you can insert a series of `set -x` and `set +x` commands within the program itself. In fact, you can insert any number of `set -x` and `set +x` commands inside your program to turn trace mode on and off as desired!

set with No Arguments

If you don't give any arguments to `set`, you'll get an alphabetized list of all the variables that exist in the current environment, local or exported:

```
$ set Show me all variables
CDPATH=:/users/steve:/usr/spool
EDITOR=/bin/vi
HOME=/users/steve
IFS=

LOGNAME=steve
MAIL=/usr/spool/mail/steve
MAILCHECK=600
PATH=/bin:/usr/bin:/users/steve/bin:.:
PHONEBOOK=/users/steve/phonebook
PS1=$
PS2=>
PWD=/users/steve/misc
SHELL=/usr/bin/sh
TERM=xterm
TMOUT=0
TZ=EST5EDT
cmd=wc
x=*
$
```

Using set to Reassign Positional Parameters

You'll recall that there's no way to assign a new value to or reassign the value of a positional parameter. Attempts to reassign `$1` to be 100, for example, might be logically written like this:

```
1=100
```

But it won't work. Positional parameters are set upon invocation of the shell program.

However, there's a sneaky trick: you can use `set` to change the value. If words are given as arguments to `set` on the command line, the positional parameters `$1`, `$2`, ... will be assigned to those words. The previous values stored in the positional parameters will be lost. Within a shell program then, the command

```
set a b c
```

will assign `a` to `$1`, `b` to `$2`, and `c` to `$3`. `$#` also gets set to 3 as appropriate for the new argument count.

Here's a more involved example:

```
$ set one two three four
$ echo $1:$2:$3:$4
```

```

one:two:three:four
$ echo $# This should be 4
4
$ echo $* What does this reference now?
one two three four
$ for arg; do echo $arg; done
one
two
three
four
$

```

After execution of the `set`, everything works as expected: `$#`, `$*`, and the `for` loop without a list all reflect the change in positional parameter values.

`set` is often used in this fashion to “parse” data read from a file or the terminal. Here’s a program called `words` that counts the number of words typed on a line (using the shell’s definition of a “word”):

```

$ cat words
#
# Count words on a line
#

read line
set $line
echo $#
$ words Run it
Here's a line for you to count.
7
$

```

The program reads the user input, storing the line read in the shell variable `line` , then executes the command

```
set $line
```

This causes each word stored in `line` to be assigned to the appropriate positional parameter. The variable `$#` is also set to the number of words assigned, which is also the number of words on the line.

The -- Option

The above works fine, but what happens if for some reason the user input starts with a `-` symbol?

```

$ words
-1 + 5 = 4
words: -1: bad option(s)
$

```

Here's what happened: After the line was read and assigned to `line`, the command

```
set $line
```

was executed and after the shell did its substitution, the command looked like this:

```
set -1 + 5 = 4
```

When `set` executed, it saw the `-` and thought that an invalid option, `-1`, was being selected. That explains the error message.

Another problem with `words` occurs if you give it a line consisting entirely of whitespace characters, or if the line is null:

```
$ words
                                Just Enter is pressed
CDPATH=./:/users/steve:/usr/spool
EDITOR=/bin/vi
HOME=/users/steve
IFS=

LOGNAME=steve
MAIL=/usr/spool/mail/steve
MAILCHECK=600
PATH=/bin:/usr/bin:/users/steve/bin:.:
PHONEBOOK=/users/steve/phonebook
PS1=$
PS2=>
PWD=/users/steve/misc
SHELL=/usr/bin/sh
TERM=xterm
TMOUT=0
TZ=EST5EDT
cmd=wc
x=*
0
$
```

In the latter case the shell saw the `set` command, but no arguments, so it output a list of all variables in the shell.

To protect against both of these problems occurring, use the `--` option to `set`. This tells `set` not to interpret any subsequent dashes or argument-format words it encounters on the command line as options. It also prevents `set` from displaying all your variables if no other arguments follow, as was the case when you typed a null line.

Reflecting this, the `set` command in `words` should be changed to read

```
set -- $line
```

With the addition of a `while` loop and some integer arithmetic, the `words` program can now be modified to count the total number of words from standard input, essentially offering you your own version of `wc -w`:

```
$ cat words
#
# Count all of the words on standard input
#

count=0
while read line
do
    set -- $line
    count=$(( count + $# ))
done

echo $count
$
```

After each line is read, the `set` command assigns all the positional parameters to the new line of information, which resets `$#` to the number of words on the line. The `--` option is included in case any of the lines begins with a `-` or is blank or lacks any alphanumeric characters.

The value of `$#` is then added to the variable `count`, and the next line is read. When the loop is exited due to the end of file being encountered, the value of `count` is displayed; that is, the total number of words read.

```
$ words < /etc/passwd
567
$ wc -w < /etc/passwd           Check against wc
567
$
```

We admit, this is a rather weird way to figure out how many words are in a file, but as you can see, the `set` command is more versatile than most Unix users realize.

Here's a quick way to count the number of files in your directory:

```
$ set *
$ echo $#
8
$
```

This is much faster than

```
ls | wc -l
```

because the first method uses only shell built-in commands. In general, your shell programs run much faster if you try to get as much done as you can using the shell's built-in commands.

Other Options to `set`

`set` accepts several other options, each enabled by preceding the option with a `-`, and disabled by preceding it with a `+`. The `-x` option that we have described here is the most commonly used but others are summarized in Appendix A, Table A.9.

The IFS Variable

There is a special shell variable called `IFS`, which stands for *internal field separator*. The shell uses the value of this variable when parsing input from the `read` command, output from command substitution (the back-quoting mechanism), and when performing variable substitution. Succinctly, `IFS` contains a set of characters that are used as whitespace separators. If it's typed on the command line, the shell treats it like a normal whitespace character (that is, as a word delimiter).

See what it's set to now:

```
$ echo "$IFS"
```

```
$
```

Well, that wasn't very illuminating! To determine the actual characters stored in there, pipe the output from `echo` into the `od` (*octal dump*) command with the `-b` (*byte display*) option:

```
$ echo "$IFS" | od -b
0000000 040 011 012 012
0000004
$
```

The first column of numbers shown is the relative offset from the start of the input.

The following numbers are the octal equivalents of the characters read by `od`. The first such number is `040`, which is the ASCII value of the space character. It's followed by `011`, the tab character, and then by `012`, the newline character. The next character is another newline which was added by `echo`. This set of characters for `IFS` should come as no surprise; they're the whitespace characters we've talked about throughout the book.

Where this gets interesting is the fact that you can change `IFS` to any character or character set desired. This can be particularly useful when you want to parse a line of data whose fields aren't delimited by the normal whitespace characters.

For example, we noted that the shell normally strips leading whitespace characters from the beginning of any line that you read with the `read` command. Change `IFS` to just a newline character before the `read` is executed, however, and it will preserve the leading whitespace (because the shell won't consider it a field delimiter):

```
$ read line Try it the "old" way
    Here's a line
$ echo "$line"
Here's a line
```

```

$ IFS=""
> "                               Set it to a just a newline
$ read line                       Try it again
    Here's a line
$ echo "$line"
    Here's a line                 Leading spaces preserved
$

```

To change IFS to just a newline, an open quote was typed, followed immediately by pressing the Enter key, followed by the closing quote on the next line. No additional characters can be typed inside those quotes because they'll be stored inside IFS and then used by the shell.

Now let's change IFS to something more visible, the colon:

```

$ IFS=:
$ read x y z
123:345:678
$ echo $x
123
$ echo $z
678
$ list="one:two:three"
$ for x in $list; do echo $x; done
one
two
three
$ var=a:b:c
$ echo "$var"
a:b:c
$

```

Because IFS was changed to a colon, when the line was read, the shell divided it into three words: 123, 345, and 678, which were then stored into the three variables x, y, and z. In the next-to-last example, the shell used IFS when substituting the value of list in the for loop. The last example demonstrates that the shell doesn't use IFS when performing variable assignment.

Changing IFS is often done in conjunction with the set command:

```

$ line="Micro Logic Corp.:Box 174:Hackensack, NJ 07602"
$ IFS=:
$ set $line
$ echo $#                               How many parameters were set?
3
$ for field; do echo $field; done
Micro Logic Corp.
Box 174
Hackensack, NJ 07602
$

```

This technique is a powerful one because it uses all built-in shell commands which makes it very fast. This technique is used in the final version of the `rollo` program as presented in Chapter 13.

The following program, called `number2` is a final version of the line numbering program presented in Chapter 9. This program prints the input lines to standard output, preceded by a line number, modifying `IFS` to ensure that leading spaces and other whitespace characters on each line of input are faithfully stored and reproduced, unlike the earlier version of the program. Notice also the use of `printf` to right-align the line numbers.

```
$ cat number2
#
# Number lines from files given as argument or from
# standard input if none supplied (final version)
#

# Modify the IFS to preserve leading whitespace on input

IFS='
' # Just a newline appears between the quotes

lineno=1

cat $* |
while read -r line
do
    printf "%5d:%s\n" $lineno "$line"
    lineno=$(( lineno + 1 ))
done
```

Here's a sample execution of `number2`:

```
$ number2 words
1:#
2:# Count all of the words on standard input
3:#
4:
5:count=0
6:while read line
7:do
8:  set -- $line
9:  count=$(( count + $# ))
10:done
11:
12:echo $count
$
```

Because `IFS` has an influence on the way things are interpreted by the shell, if you're going to change it in your program it's usually wise to save the old value first in another variable (such as `OIFS`) and then restore it after you've finished the operations.

The `readonly` Command

The `readonly` command is used to specify variables whose values cannot be subsequently changed. For example,

```
readonly PATH HOME
```

marks both `PATH` and `HOME` variables as read-only. Subsequent attempts to assign a value to either variable causes the shell to issue an error message:

```
$ PATH=/bin:/usr/bin:.  
$ readonly PATH  
$ PATH=$PATH:/users/steve/bin  
sh: PATH: is read-only  
$
```

Here you see that after the variable `PATH` was made read-only, the shell printed an error message when an attempt was made to assign a value to it.

To get a list of your read-only variables, type `readonly -p` without any arguments:

```
$ readonly -p  
readonly PATH=/bin:/usr/bin:.  
$
```

The read-only variable attribute is not passed down to subshells. Also, after a variable has been made read-only in a shell, there is no way to “undo” it.

The `unset` Command

Sometimes you may want to remove the definition of a variable from your environment. To do so, you type `unset` followed by the names of the variables:

```
$ x=100  
$ echo $x  
100  
$ unset x  
$ echo $x  
  
$
```

Remove x from the environment

You can't `unset` a read-only variable. Furthermore, the variables `IFS`, `MAILCHECK`, `PATH`, `PS1`, and `PS2` cannot be `unset`.

Loose Ends

We've put commands and features into this chapter that did not fit into earlier chapters. There's no particular rationale for their order of presentation, so this is your chance to simply expand your knowledge of shell programming tricks and techniques.

The `eval` Command

This section describes one of the more unusual shell commands: `eval`. Its format is as follows:

```
eval command-line
```

where *command-line* is a normal command line that you would type at the terminal. When you put `eval` in front of it, however, the effect is that the shell scans the command line *twice* before executing it, which can be very useful if the script is building a command that needs to be invoked, among other purposes.

For the simple case, using `eval` seems to have no effect:

```
$ eval echo hello
hello
$
```

But consider the following example without the use of `eval`:

```
$ pipe="|"
$ ls $pipe wc -l
|: No such file or directory
wc: No such file or directory
-l: No such file or directory
$
```

Those `ls` errors are because the value of `pipe` and the subsequent call to `wc -l` are all interpreted as command arguments. The shell takes care of pipes and I/O redirection *before* variable substitution, so it never properly interprets the pipe symbol inside `pipe`.

Putting `eval` in front of the command sequence gives the desired results, however:

```
$ eval ls $pipe wc -l
      16
$
```

The first time the shell scans the command line, it substitutes `|` as the value of `pipe`. Then `eval` causes it to rescan the line, at which point the `|` is recognized by the shell as the pipe symbol and everything proceeds as desired.

The `eval` command is frequently used in shell programs that build up command lines inside one or more variables. If the variables contain any characters that must be interpreted by the shell, `eval` is essential. Command terminator (`;`, `|`, `&`), I/O redirection (`<`, `>`), and quote characters are among the characters that must appear directly on the command line to have special meaning to the shell.

For the next example, consider the program `last` whose sole purpose is to display the last argument passed to it. Recall the `mycp` program from Chapter 9 where we accomplished this task by shifting all the arguments until only one was left.

It turns out you can accomplish the same result by using `eval`:

```
$ cat last
eval echo \$$#
$ last one two three four
four
$ last *                Get the last file
zoo_report
$
```

The first time the shell scans

```
echo \$$#
```

the backslash tells it to ignore the `$` that immediately follows. After that, it encounters the special parameter `$#`, so it substitutes its value on the command line. The command now looks like this:

```
echo $4
```

The backslash is removed by the shell after the first scan. When the shell rescans this line, it substitutes the value of `$4` and then executes `echo`.

This same technique could be used if you had a variable called `arg` that contained a digit, for example, and you wanted to display the positional parameter referenced by `arg`. You could simply write

```
eval echo \$$arg
```

The only problem with this approach is that only the first nine positional parameters can be accessed this way because accessing positional parameters 10 and above requires the `${n}` notation. So here's a second attempt:

```
eval echo \${$arg}
```

The `eval` command can also be used to effectively create “pointers” to variables:

```
$ x=100
$ ptrx=x
$ eval echo \$$ptrx      Dereferece ptrx
100
$ eval $ptrx=50          Store 50 in var that ptrx points to
$ echo $x                See what happened
50
$
```

The wait Command

If you move a command into the background for execution, that command line runs in a subshell independent of your current shell (the job is said to run *asynchronously*). In some situations, however, you may want to wait for the background process (also known as a *child* process because it’s spawned from your current shell—the *parent*) to finish execution before proceeding. For example, you may have sent a large `sort` into the background and need to wait for it to finish before you access the sorted data.

The `wait` command does the job. Its general format is

```
wait process-id
```

where *process-id* is the process ID of the process you want to complete. If the process ID is omitted, the shell waits for all child processes to complete execution. Execution of your current shell will be suspended until the process or processes finish execution.

You can try the `wait` command at your terminal:

```
$ sort big-data > sorted_data &      Send it to the background
[1] 3423                               Job number & process id from the shell
$ date                                Do some other work
Wed Oct  2 15:05:42 EDT 2002
$ wait 3423                            Now wait for the sort to finish
$                                       When sort finishes, prompt is returned
```

The \$! Variable

If you have only one process running in the background, then `wait` with no argument suffices. However, if you’re running more than one background command and you want to wait on the most recently launched, you can access the process ID of the most recent background command as the special variable `$!`. So the command

```
wait $!
```

waits for the last process sent to the background to complete execution. With some intermediate variables involved, you can also save their process ID values for later access too:

```
prog1 &
pid1=$!
...
prog2 &
pid2=$!
...
wait $pid1          # wait for prog1 to finish
...
wait $pid2          # wait for prog2 to finish
```

Tip: Want to test if a process you've launched is still running? The `ps` command can check if you use the `-p` flag and the process ID.

The `trap` Command

When you press the `DELETE` or `BREAK` key at your terminal during execution of a shell program, that program is typically terminated and you're prompted for your next command. This may not always be desirable in shell programs. For instance, you may end up leaving a bunch of temporary files that won't get cleaned up as they would on normal program completion.

Pressing the `DELETE` key sends what's known as a *signal* to the executing program, and programs can specify what action should be taken on receipt of the signal rather than just relying on default actions like immediately exiting the process.

Signal handling in a shell program is done with the `trap` command, whose general format is

```
trap commands signals
```

where *commands* is one or more commands that will be executed whenever any of the signals specified by *signals* is received.

Mnemonic names and numbers are assigned to the different types of signals, and the more commonly used ones are summarized in Table 12.1. A more complete list is given under the `trap` command in Appendix A.

Table 12.1 Commonly Used Signal Numbers

Signal	Mnemonic Name	Generated for
0	EXIT	Exit from the shell
1	HUP	Hangup
2	INT	Interrupt (for example, <code>DELETE</code> , <code>Ctrl+c</code> key)
15	TERM	Software termination signal (sent by <code>kill</code> by default)

As an example of the `trap` command, the following shows how you can remove some files and then exit if someone tries to interrupt the program from the terminal:

```
trap "rm $WORKDIR/work1$$ $WORKDIR/dataout$$; exit" INT
```

Once this `trap` is executed, the two files `work1$$` and `dataout$$` will be automatically removed if a `SIGINT` (signal number 2) is received by the program. If the user interrupts execution of the program after this `trap` is executed, you can be assured that these two temporary files will be removed, not left around in the file system. The `exit` that follows the `rm` is necessary because without it execution would continue in the program at the point that it left off when the signal was received.

Signal number 1—`SIGHUP` or just `HUP`—is generated for hangup: originally this related to dialup connections, but now more generally refers to an unexpected disconnect like the Internet connection dropping. You can modify the preceding `trap` to also remove the two specified files in this case by adding a `SIGINT` to the list of signals:

```
trap "rm $WORKDIR/work1$$ $WORKDIR/dataout$$; exit" INT HUP
```

Now these files will be removed if the line gets hung up or if the user interrupts processing with the `DELETE` key or `Ctrl+c`.

The sequence specified to `trap` (also known as the *trap handler*) must be enclosed in quotes if it contains more than one command. Also note that the shell scans the command line at the time that the `trap` command gets executed and also again when one of the listed signals is received.

In the preceding example, the value of `WORKDIR` and `$$` will be substituted at the time that the `trap` command is executed. If you wanted this substitution to occur at the time that a signal was received, you can put the commands inside single quotes:

```
trap 'rm $WORKDIR/work1$$ $WORKDIR/dataout$$; exit' INT HUP
```

The `trap` command can be used to make your programs more user friendly too. In a further revision to the `rolo` program in the next chapter, the `Ctrl+c` interrupt signal will be caught by the program and return the user to the main menu, not have the program quit completely.

trap with No Arguments

Executing `trap` with no arguments results in the display of any trap handlers that you have defined or modified:

```
$ trap 'echo logged off at $(date) >>$HOME/logoffs' EXIT
$ trap                               List changed traps
trap - 'echo logged off at $(date) >>$HOME/logoffs' EXIT
$ Ctrl+d                               Log off
login: steve                            Log back in
Password:
$ cat $HOME/logoffs                     See what happened
logged off at Wed Oct  2 15:11:58 EDT 2002
$
```

A trap was set to be executed whenever the shell exited—signal 0, `EXIT`—was received by the shell. Because this was set in the login shell, the trap handler is used when you log off to write the time you logged off into the file `$HOME/logoffs`. The command is enclosed in single quotes to prevent the shell from executing `date` when the trap is defined.

The `trap` command is then executed with no arguments which lists the new action to be taken for signal 0 (`EXIT`). When `steve` then logs off and back on again, the file `$HOME/logoffs` verifies that the `echo` command was executed and the trap worked.

Ignoring Signals

If the command listed for `trap` is null, the specified signal will be ignored when received. For example, the command

```
trap "" SIGINT
```

specifies that the interrupt signal is to be ignored. You might want to ignore certain signals when performing some operation that you don't want interrupted.

Note that `trap` lets you specify signals by signal number, by shortened name (`INT`) or by the full signal name (`SIGINT`). We encourage you to use mnemonic names to help produce readable code, but it is, of course, up to you which you prefer.

In the above example, the first argument must be specified as a null value for a signal to be ignored and is not equivalent to writing the following, which has a separate meaning of its own:

```
trap 2
```

If you ignore a signal, all subshells also ignore that signal. If you specify a signal handler action, however, all subshells will automatically take the *default* action on receipt of that signal, not the new code sequence.

Suppose that you execute the command

```
trap "" 2
```

and then start a subshell, which in turn executes other shell programs as subshells. If an interrupt signal is then generated, it will have no effect on the shells or subshells that are executing because they will all ignore the signal by default.

If instead of executing the previous `trap` command you execute

```
trap : 2
```

and then execute your subshells, then the current shell will do nothing on receipt of an interrupt (it will execute the `null` command), while subshells will be terminated (the default action).

Resetting Traps

After you've changed the default action to be taken on receipt of a signal, you can change it back again with `trap` if you simply omit the first argument; so

```
trap HUP INT
```

resets the action to be taken on receipt of the `SIGHUP` or `SIGINT` signals back to the default behavior for the shell.

Many shell programs also use a construct like this

```
trap "/bin/rm -f $tempfile; exit" INT QUIT EXIT
```

to ensure that the `rm` command won't produce an error message if the temporary file hasn't yet been created upon exit. The trap handler removes the temporary file if it exists and does nothing if it doesn't.

More on I/O

You know about the standard constructs `<`, `>`, and `>>` for input redirection, output redirection, and output redirection with append, respectively. You also know that you can redirect standard error from any command simply by writing `2>` instead of just `>`:

```
command 2> file
```

Sometimes you may want to explicitly write to standard error in your program. With a slight variation on the above, you can redirect standard output to standard error by writing

```
command >&2
```

The notation `>&` specifies output redirection to a file associated with the *file descriptor* that follows. File descriptor 0 is standard input, descriptor 1 is standard output, and descriptor 2 is standard error. It's important to remember that no space is permitted between the `>` and the `&`.

To write a message to standard error:

```
echo "Invalid number of arguments" >&2
```

You may want to redirect both standard output (often abbreviated "stdout") and standard error output ("stderr") from a program into the same file. If you know the name of the file, this is straightforward:

```
command > foo 2>> foo
```

Here both stdout and stderr will be written to `foo`.

You can also write

```
command > foo 2>&1
```

to achieve the same effect; standard output is redirected to `foo`, and standard error is redirected to standard output (which has already been redirected to `foo`). Because the shell evaluates

redirection from left to right on the command line, the last example won't work properly if the `stderr` redirection sequence appears first on the command line

```
command 2>&1 > foo
```

because this would first redirect standard error to standard output then standard output to `foo`.

You can also dynamically redirect standard input or output in a program using the `exec` command:

```
exec < datafile
```

redirects standard input from the file `datafile`. Subsequent commands executed that read from standard input will read from `datafile` instead. The command

```
exec > /tmp/output
```

does the same thing with standard output: all commands that subsequently write to standard output will write to `/tmp/output` unless explicitly redirected elsewhere.

Naturally, standard error can be reassigned as well:

```
exec 2> /tmp/errors
```

All subsequent output to standard error will go to `/tmp/errors`.

<&- and >&-

The sequence `>&-` has the effect of closing standard output. If preceded by a file descriptor, the associated file is closed instead. So writing

```
ls >&-
```

causes the output from `ls` to go nowhere because standard output is closed by the shell before `ls` is executed. Not hugely useful, we admit!

In-line Input Redirection

If the `<<` characters follow a command in the format

```
command <<word
```

the shell uses the lines that follow as the input for `command`, until a line that contains just `word` is found. Here's a simple example:

```
$ wc -l <<ENDOFDATA           Use lines up to ENDOFDATA as standard input
> here's a line
> and another
> and yet another
> ENDOFDATA
    3
$
```

The shell fed every line typed into the shell as the standard input stream of `wc` until it encountered the line containing just `ENDOFDATA`.

In-line input redirection—also referred to as *here documents* by some programmers—is a powerful feature when used inside shell programs. It lets you specify the standard input to a command directly in the program, thus obviating the need to write it into a separate file, or to use `echo` to get it into the standard input of the command.

Here's a common example of how this feature is used within a shell program:

```
$ cat mailmsg
mail $* <<END-OF-DATA
```

Attention:

```
Our monthly computer users group meeting
will take place on Friday, March 4, 2016 at
8pm in Room 1A-308. Please try to attend.
```

```
END-OF-DATA
$
```

To send this message to all members of the group as stored in the file `users_list`, you could invoke

```
mailmsg $(cat users_list)
```

The shell performs parameter substitution for the redirected input data, executes back-quoted commands, and recognizes the backslash character.

Special characters within a *here document* are generally ignored, but if you include dollar signs, back quotes, or backslashes in these lines, they can be interpreted. To have them ignored, precede them with a backslash character. Alternatively, if you want the shell to leave all input lines completely untouched, precede the end of document word that follows the `<<` with a backslash.

Let's highlight the difference between the two:

```
$ cat <<FOOBAR
> $HOME
> *****
> \ $foobar
> `date`
> FOOBAR
/users/steve
*****
$foobar
Wed Oct 2 15:23:15 EDT 2002
$
```

Terminates the input

Since the shell supplies all the lines up to `FOOBAR` as the input to `cat` it substitutes the value for `HOME` but not for `foobar` because the latter is prefaced with a backslash. The `date` command is also executed because back quotes are interpreted by the shell.

To side-step all the issues with the shell interpreting the contents of the lines, use backslash *on the end-of-document word* instead:

```
$ cat <<\FOOBAR
> \\\
> `date`
> $HOME
> FOOBAR
\\
`date`
$HOME
$
```

Use care when selecting the word that follows the `<<`. Generally, just make sure that it's weird enough so that the chances of it accidentally appearing in the subsequent lines of data are miniscule.

You now know about the `<<\` sequence, but there's another one that most modern shells understand: If the first character that follows the `<<` is a dash (`-`), any leading tab characters in the input will be removed by the shell. This is useful for visually indenting the redirected text for readability while still having it output appear in normal left-aligned form:

```
$ cat <<-END
>         Indented lines
>         because tabs are cool
> END
Indented lines
because tabs are cool
$
```

Shell Archives

One of the best uses of the in-line input redirection feature is for creating *shell archive* files. With this technique, one or more related shell programs can be put into a single file and then sent to someone else using the standard Unix `mail` commands. When the archive is received, it can be “unpacked” by invoking it as a shell program.

For example, here's an archived version of the `lu`, `add`, and `rem` programs used by `rolo`:

```
$ cat rolosubs
#
# Archived programs used by rolo.
#
```

```
echo Extracting lu
```

```

cat >lu <<\THE-END-OF-DATA
#
# Look someone up in the phone book
#

if [ "$#" -ne 1 ]
then
    echo "Incorrect number of arguments"
    echo "Usage: lu name"
    exit 1
fi

name=$1
grep "$name" $PHONEBOOK

if [ $? -ne 0 ]
then
    echo "I couldn't find $name in the phone book"
fi
THE-END-OF-DATA

echo Extracting add
cat >add <<\THE-END-OF-DATA
#
# Program to add someone to the phonebook file
#

if [ "$#" -ne 2 ]
then
    echo "Incorrect number of arguments"
    echo "Usage: add name number"
    exit 1
fi

echo "$1 $2" >> $PHONEBOOK
sort -o $PHONEBOOK $PHONEBOOK
THE-END-OF-DATA

echo Extracting rem
cat >rem <<\THE-END-OF-DATA
#
# Remove someone from the phone book
#

if [ "$#" -ne 1 ]
then
    echo "Incorrect number of arguments"

```

```

        echo "Usage: rem name"
        exit 1
    fi

name=$1

#
# Find number of matching entries
#

matches=$(grep "$name" $PHONEBOOK | wc -l)

#
# If more than one match, issue message, else remove it
#

if [ "$matches" -gt 1 ]
then
    echo "More than one match; please qualify further"
elif [ "$matches" -eq 1 ]
then
    grep -v "$name" $PHONEBOOK > /tmp/phonebook
    mv /tmp/phonebook $PHONEBOOK
else
    echo "I couldn't find $name in the phone book"
fi
THE-END-OF-DATA
$

```

To be complete, this archive would include `rolo` as well, but we didn't include it here to conserve space in the book.

This shell archive offers one portable file, `rolosubs`, that contains the source for all three programs `lu`, `add`, and `rem`, and can be sent to someone else using mail:

```

$ mail tony@aisystems.com < rolosubs           Mail the archive
$ mail tony@aisystems.com                     Mail tony a message

```

Tony,

```

    I mailed you a shell archive containing the programs
    lu, add, and rem. rolo itself will be sent along shortly.

```

Pat

```

Ctrl+d
$

```

When `tony` receives the file in his mail, she can extract the three programs by saving the message, then running the shell on the file (after having first removed any email header lines that might have ended up in the beginning of the file):

```

$ sh rolosubs
Extracting lu
Extracting add
Extracting rem
$ ls lu add rem
add
lu
rem
$

```

To generalize this process, here's a simple shell program, `shar`, that can produce a shell archive that contains every specified script in a neat, ready-to-email format:

```

$ cat shar
#
# Program to create a shell archive
# from a set of files
#

echo "#"
echo "# To restore, type sh archive"
echo "#"

for file
do
    echo
    echo "echo Extracting $file"
    echo "cat >$file <<\THE-END-OF-DATA"
    cat $file
    echo "THE-END-OF-DATA"
done

```

Flip back to look at the contents of the `rolosubs` file when studying the operation of this `shar` program and remember, `shar` actually creates a shell program, not just a generic output file.

More sophisticated archiving programs allow entire directories to be included and use various techniques to ensure that no data is lost in the transmission (see Exercises 2 and 3 at the end of this chapter).

The `sum` and `cksum` commands can be used to generate a *checksum* for a program too. This checksum can be generated on the sending end for each file in the archive, and then the shell archive can verify the checksum for each unpacked file on the receiving end. If they don't match, an error message can be displayed and the user will be alerted something went wrong with the process.

Functions

All modern shells support functions—long or short sequences of commands that can be referenced or reused as often as desired in a shell program.

To define a function, you use the general format:

```
name () { command; ... command; }
```

where *name* is the name of the function, the parentheses denote that a function is being defined, and the commands enclosed between the curly braces define the body of the function. These commands will be executed whenever the function is executed.

Note that at least one whitespace character must separate the { from the first command, and that a semicolon must separate the last command from the closing brace if they occur on the same line.

The following defines a function called `nu` that displays the number of logged-in users:

```
nu () { who | wc -l; }
```

You execute a function the same way you execute an ordinary command: by typing its name into the shell:

```
$ nu
    22
$
```

Functions are really useful for shell programmers and can alleviate lots of tedium in developing solutions. One key feature: arguments listed after the function on the command line are assigned to the positional parameters `$1`, `$2`, . . . , within the function, just as with any other command.

Here's a function called `nrrun` that runs `tbl`, `nroff`, and `lp` on the file specified:

```
$ nrrun () { tbl $1 | nroff -mm -Tlp | lp; }
$ nrrun memo1 Run it on memo1
request id is laser1-33 (standard input)
$
```

Functions exist only in the shell in which they're defined so they can't be passed to subshells. Because the function is executed in the current shell, changes made to the current directory or to variables remain after the function has completed execution, as if it had been invoked with the `.` command explored earlier in the book:

```
$ db () {
>     PATH=$PATH:/uxn2/data
>     PS1=DB:
>     cd /uxn2/data
>     }
$ db Execute it
DB:
```

A function definition can continue over as many lines as necessary. The shell will continue to prompt for commands within the function with the secondary command prompt until you complete the function definition with the `}`.

You can put definitions for commonly used functions inside your `.profile` so that they'll be available whenever you log in. Alternatively, you can group the definitions in a file, say `myfuncs`, and then execute the file in the current shell by typing

```
. myfuncs
```

As you now know, this causes any functions defined inside `myfuncs` to become available in the current shell.

The following function, called `mycd`, takes advantage of the fact that functions are run in the current environment. It mimics the operation of the Korn shell's `cd` command, which has the capability of substituting portions of the current directory's path (see the discussion of `cd` in Chapter 14 for more explanation).

```
$ cat myfuncs                                See what's inside
#
# new cd function:
#   mycd dir Switches dir
#   mycd old new   Substitute new for old in current directory's path
#
mycd ()
{
    if [ $# -le 1 ] ; then
        # normal case -- 0 or 1 argument
        cd $1
    elif [ $# -eq 2 ] ; then
        # special case -- substitute $2 for $1
        cd $(echo $PWD | sed "s|$1|$2|")
    else
        # cd can't have more than two arguments
        echo mycd: bad argument count
        exit 1
    fi
}
```

```
$ . myfuncs                                Read in definition
$ pwd
/users/steve
$ mycd /users/pat                          Change directory
$ pwd                                       Did it work?
/users/pat
$ mycd pat tony                            Substitute tony for pat
$ pwd
/users/tony
$
```

Functions execute faster than an equivalent shell program because the shell doesn't have to search the disk for the program, open the file, and read its contents into memory; it can just jump right into executing the individual commands directly.

Another advantage of functions is the capability to group related shell programs in a single file. For example, the `add`, `lu`, and `rem` programs from Chapter 10 can now be defined as individual functions within the `rolo` program file. The template for such an approach is shown:

```
$ cat rolo
#
# rolo program written in function form
#
#
# Function to add someone to the phonebook file
#
add () {
    # put commands from add program here
}

#
# Function to look someone up in the phone book
#
lu () {
    # put commands from lu program here
}

#
# Function to remove someone from the phone book
#
rem () {
    # put commands from rem program here
}

#
# rolo - rolodex program to look up, add, and
#     remove people from the phone book
#
# put commands from rolo here
$
```

None of the commands inside the original `add`, `lu`, `rem`, or `rolo` programs would have to be changed. The first three are turned into functions by including them inside `rolo`, sandwiched

between the function header and the closing curly brace. Defining them as functions would, however, make them inaccessible as standalone commands.

Removing a Function Definition

To remove the definition of a function from the shell, use the `unset` command with the `-f` option. Look familiar? It is the same command you use to remove the definition of a variable from the shell.

```
$ unset -f nu
$ nu
sh: nu: not found
$
```

The `return` Command

If you use `exit` from inside a function, its effect is not only to terminate execution of the function but also of the shell program that called the function. It exits all the way back to the command line. If you instead want to just exit the function, use the `return` command, whose format is

```
return n
```

The value *n* is used as the return status of the function. If omitted, the status is that of the last command executed. This is also what gets returned if you don't include a `return` statement in your function. The return status is in all other ways equivalent to the exit status: you can access its value through the shell variable `?`, and you can test it in `if`, `while`, and `until` commands.

The `type` Command

When you `type` in the name of a command to execute, it's useful to know whether the command is a function, a shell built-in function, a standard Unix command or even a shell alias. This is where the `type` command comes in handy. The `type` command takes one or more command names as its argument and tells you what it knows about it. Here are some examples:

```
$ nu () { who | wc -l; }
$ type pwd
pwd is a shell builtin
$ type ls
ls is aliased to `~/bin/ls -F`
$ type cat
cat is /bin/cat
$ type nu
nu is a function
$
```

This page intentionally left blank

Rolo Revisited

This chapter presents the final, much improved version of the `rolo` program enhanced with additional options and also allows for more general types of entries (other than just names and numbers). The sections in this chapter discuss the individual components of `rolo`, starting with the main `rolo` program itself. At the end of this chapter, sample output is shown.

Data Formatting Considerations

While the initial name-and-number `rolo` program shown earlier in the book is handy, there's no question that a more useful program would allow more than just the names and numbers to be stored. You'd probably want to save addresses and email addresses too, for example. The new `rolo` program allows entries in the phone book to consist of multiple lines. A typical entry might be

```
Steve's Ice Cream
444 6th Avenue
New York City 10003
212-555-3021
```

To increase the flexibility of the program, an individual entry can now contain as many lines as desired. Another entry in the phone book might read

```
YMCA
(201) 555-2344
```

To logically separate entries in the phone book file, each entry is “packed” into a single line by replacing the terminating newline characters in an entry with a different character. We arbitrarily chose the caret `^` as it appears very rarely in regular user input, addresses, etc. The only repercussion of this decision is that this character cannot be used as part of the entry itself.

Using this technique, the first entry shown would be stored in the phone book file as

```
Steve's Ice Cream^444 6th Avenue^New York City 10003^212-555-3021^
```

and the second entry as

```
YMCA^(201) 555-2344^
```

It now becomes quite easy to work with entries when they're stored in this format, a testament to how really thinking through a problem and solution can reap great benefits as it's developed further.

rolo

```
#
# rolo - rolodex program to look up, add,
#       remove and change entries from the phone book
#
#
# Set PHONEBOOK to point to the phone book file
# and export it so other progs know about it
# if it's set on entry, then leave it alone
#
: ${PHONEBOOK:=${HOME}/phonebook}
export PHONEBOOK
if [ ! -e "$PHONEBOOK" ] ; then
    echo "$PHONEBOOK does not exist!"
    echo "Should I create it for you (y/n)? \c"
    read answer

    if [ "$answer" != y ] ; then
        exit 1
    fi

    > $PHONEBOOK || exit 1      # exit if the creation fails
fi

#
# If arguments are supplied, then do a lookup
#
if [ "$#" -ne 0 ] ; then
    lu "$@"
    exit
fi

#
# Set trap on interrupt (DELETE key) to continue the loop
#
```

```
trap "continue" SIGINT

#
# Loop until user selects 'exit'
#

while true
do
    #
    # Display menu
    #

    echo '
Would you like to:

        1. Look someone up
        2. Add someone to the phone book
        3. Remove someone from the phone book
        4. Change an entry in the phone book
        5. List all names and numbers in the phone book
        6. Exit this program

Please select one of the above (1-6): \c'

    #
    # Read and process selection
    #

    read choice
    echo
    case "$choice"
    in
        1) echo "Enter name to look up: \c"
            read name

            if [ -z "$name" ] ; then
                echo "Lookup ignored"
            else
                lu "$name"
            fi;;
        2) add;;
        3) echo "Enter name to remove: \c"
            read name
            if [ -z "$name" ] ; then
                echo "Removal ignored"
            else
                rem "$name"
            fi;;
    esac
done
```

```

4) echo "Enter name to change: \c"
   read name
   if [ -z "$name" ] ; then
       echo "Change ignored"
   else
       change "$name"
   fi;;
5) listall;;
6) exit 0;;
*) echo "Bad choice\a";;
esac
done

```

One improvement appears in the very beginning of the new code: Instead of requiring that the user already have a phone book file in their home directory, the program checks to see whether the variable `PHONEBOOK` has been set. If it has, it's assumed that it contains the name of the phone book file. If it hasn't, it's set to `$HOME/phonebook` as the default.

The program then checks to see whether the actual file exists, and if it doesn't, asks the user whether they would like to have it created. This greatly improves that first use experience, as you can imagine.

This version of `rolo` also has a couple of new choices on the menu too. Because individual entries can be rather long, an edit option now allows the user to update a particular entry. Prior to this, of course, the only way to change an entry was to remove it, then add a completely new entry.

Another option lists the entire phone book. With this option, just the first and last lines (fields) of each entry are displayed. This assumes that the user follows some convention such as putting the name on the first line and the number on the last.

The entire menu selection code block is also now inside a `while` loop so that `rolo` will continue to display menus until the user chooses to exit the program.

As per our discussion last chapter, notice that a `trap` command is executed before the loop is entered. This `trap` specifies that a `continue` command is to be executed if an interrupt (`SIGINT`) is generated by the user. If the user presses `Ctrl+C` in the middle of an operation (such as listing the entire phone book), the program will stop the current operation and redisplay the main menu.

Because entries can now span as many lines as desired, the action performed when `add` is selected has been changed too. Instead of asking for the name and number, `rolo` invokes the `add` program to get the entry and lets the function take care of prompting the user and figuring out when the data input is done.

For the lookup, change, and remove options, a check is now made to ensure that the user doesn't end a null value by pressing the `Enter` key when asked to type in the name. This avoids the regular expression error that `grep` would otherwise issue if given a null first argument.

Now let's look at the individual programs that `rol0` utilizes, with particular attention paid to how the change in data format ripples through the entire design. Each of the original programs has been changed to accommodate the new entry format and also to be more user friendly.

add

```
#
# Program to add someone to the phonebook file
#

echo "Type in your new entry"
echo "When you're done, type just a single Enter on the line."

first=
entry=

while true
do
    echo ">> \c"
    read line

    if [ -n "$line" ] ; then
        entry="$entry$line^"

        if [ -z "$first" ] ; then
            first=$line
        fi
    else
        break
    fi
done

echo "$entry" >> $PHONEBOOK
sort -o $PHONEBOOK $PHONEBOOK
echo
echo "$first has been added to the phone book"
```

This program adds an entry to the phone book. It continually prompts the user to enter lines until a line with just an `Enter` is typed (that is, a completely blank line). Each line that is entered is appended to the variable `entry`, with the special `^` character used to logically separate fields.

When the `while` loop is exited, the new entry is added to the end of the phone book, and the file is sorted.

lu

```

#
# Look someone up in the phone book
#

name="$1"
grep -i "$name" $PHONEBOOK > /tmp/matches$$

if [ ! -s /tmp/matches$$ ] ; then
    echo "I can't find $name in the phone book"
else
    #
    # Display each of the matching entries
    #

    while read line
    do
        display "$line"
    done < /tmp/matches$$
fi

rm /tmp/matches$$

```

This is the program to look up an entry in the phone book. Now, however, matching entries are written to the file `/tmp/matches$$` so we can improve the user experience in the situation where there are no matches.

If the size of this output file is zero (`test -s`), no match was found. Otherwise, the program enters a loop to read each matching line from the file and display it to the user. A new program called `display` is used to unwrap `^-`separated fields and turn them into multi-line output entries. This new program is also used by the `rem` and `change` programs to display entries.

Also note the addition of the `-i` flag to `grep` in the script. This allows case-insensitive matches, so a search for “`steve`” will match “`Steve`.” A good example of how a working knowledge of the flags to key Unix commands can easily make your scripts more powerful and easier to use.

display

```

#
# Display entry from the phonebook
#

echo
echo "-----"

```

```

entry=$1
IFS="^"
set $entry

for line in "$1" "$2" "$3" "$4" "$5" "$6"
do
    printf "| %-34.34s |\n" $line
done
echo "|           o                   o           |"
echo "-----"
echo

```

This program displays the caret-separated entry passed as its argument. To make the output more aesthetically interesting, the program actually “draws” a rolodex card. Typical output from `display` looks like this:

```

-----
| Steve's Ice Cream           |
| 444 6th Avenue             |
| New York City 10003        |
| 212-555-3021              |
|                             |
|           o                   o           |
|                             |
-----

```

Look at the code again and notice how after skipping a line and displaying the top of the card, `display` changes `IFS` to `^`, then executes the `set` command to assign each “line” to a different positional parameter. For example, if `entry` is equal to

```
Steve's Ice Cream^444 6th Avenue^New York City 10003^212-555-3021^
```

executing the `set` command assigns `Steve's Ice Cream` to `$1`, `444 6th Avenue` to `$2`, `New York City 10003` to `$3`, and `212-555-3021` to `$4`.

After breaking down the fields with `set`, the program enters a `for` loop that, with this version of the code, will output six lines of data, no matter how many lines are contained in the entry. This ensures uniformity of rolodex cards and the program can be easily modified to “draw” larger-sized cards if desired.

If the `set` command was executed on `Steve's Ice Cream` as shown previously, `$5` and `$6` would be null, thus resulting in two blank lines to “fill out” the bottom of the card.

To ensure that the output is properly aligned on both left and right edges, the `printf` command is used to display a line exactly 38 characters wide: the leading `|` followed by a space followed by the first 34 characters of `$line` followed by a space and a `|`.

`rem`

```

#
# Remove someone from the phone book
#

name=$1

#
# Get matching entries and save in temp file
#

grep -i "$name" $PHONEBOOK > /tmp/matches$$
if [ ! -s /tmp/matches$$ ] ; then
    echo "I can't find $name in the phone book"
    exit 1
fi

#
# Display matching entries one at a time and confirm removal
#

while read line
do
    display "$line"
    echo "Remove this entry (y/n)? \c"
    read answer < /dev/tty

    if [ "$answer" = y ] ; then
        break
    fi
done < /tmp/matches$$

rm /tmp/matches$$

if [ "$answer" = y ] ; then
    if grep -i -v "^$line$" $PHONEBOOK > /tmp/phonebook$$
    then
        mv /tmp/phonebook$$ $PHONEBOOK
        echo "Selected entry has been removed"
    elif [ ! -s $PHONEBOOK ] ; then
        echo "Note: You now have an empty phonebook."
    else
        echo "Entry not removed"
    fi
fi

```

The `rem` program collects all matching entries into a temporary file, then tests the result: If the size of the file is zero, no match was found and an error message is issued. Otherwise, for each matching entry, the program displays the entry and asks the user whether that entry should be removed.

From a user experience perspective, this type of coding practice provides reassurance to the user that the entry they intend to remove is the same one that the program is going to remove, even in the single match case.

After the user has answered the prompt with `y`, a `break` command exits the loop. Outside the loop, the program then tests the value of `answer` to determine how the loop was exited. If its value is not equal to `y`, then the user doesn't want to remove an entry after all (for whatever reason). Otherwise, the program proceeds with the requested removal by `grep`ing all lines that don't match the specified pattern. Note that `grep` matches only entire lines by anchoring the regular expression to the start and end of the line.

Note also that in the edge case of the user removing the last entry in their phonebook, the script now recognizes the situation (by testing to see if the file exists and is non-zero in size) and outputs an informative message. It's not an error, but it ensures that the failure message that would otherwise be triggered by the `grep -v` invocation isn't displayed.

change

```
#
# Change an entry in the phone book
#

name=$1

#
# Get matching entries and save in temp file
#

grep -i "$name" $PHONEBOOK > /tmp/matches$$
if [ ! -s /tmp/matches$$ ] ; then
    echo "I can't find $name in the phone book"
    exit 1
fi

#
# Display matching entries one at a time and confirm change
#

while read line
do
    display "$line"
    echo "Change this entry (y/n)? \c"
```

```

        read answer < /dev/tty

        if [ "$answer" = y ] ; then
            break
        fi
done < /tmp/matches$$

rm /tmp/matches$$

if [ "$answer" != y ] ; then
    exit
fi

#
# Start up editor on the confirmed entry
#

echo "$line\c" | tr '^' '\012' > /tmp/ed$$

echo "Enter changes with ${EDITOR:=/bin/vi}"
trap "" 2          # don't abort if DELETE hit while editing
$EDITOR /tmp/ed$$

#
# Remove old entry now and insert new one
#

grep -i -v "^$line$" $PHONEBOOK > /tmp/phonebook$$
{ tr '\012' '^' < /tmp/ed$$; echo; } >> /tmp/phonebook$$
# last echo was to put back trailing newline translated by tr

sort /tmp/phonebook$$ -o $PHONEBOOK
rm /tmp/ed$$ /tmp/phonebook$$

```

The change program allows the user to edit an entry in the phone book. The first portion of the code ends up virtually identical to `rem`: it finds the matching entries and then prompts the user to select which one to change.

The selected entry is then written into the temporary file `/tmp/ed$$`, with the `^` characters translated to newlines. This “unfolds” the entry into separate lines to be consistent with how `rolo` displays the entry and for easier editing. The program then displays the message

```
echo "Enter changes with ${EDITOR:=/bin/vi}"
```

This serves a dual purpose: it tells the user what editor will be used to make the change and sets the variable `EDITOR` to `/bin/ed vi` if it's not already set. This technique allows the user to use their preferred editor by simply assigning its name to the variable `EDITOR` before executing `rolo`:

```
$ EDITOR=emacs rolo
```

The signal generated by the `DELETE` key (2) is ignored so that if the user presses this key while in the editor, the `change` program won't abort. The editor is then launched so that the user can make whatever changes are required. Once done, the program continues by removing the old entry from the phone book file with `grep`, then the modified entry is converted back to having `^` field separators and appended to the end of the file. An extra newline character must be added here to make sure that a newline is stored in the file after the new entry, easily done with an `echo` with no arguments.

Finally, the phone book file is sorted and the temporary files removed.

listall

```
#
# list all of the entries in the phone book
#

IFS='^'      # to be used in set command below
echo "-----"
while read line
do
    #
    # Get the first and last fields, presumably names and numbers
    #

    set $line

    #
    # display 1st and last fields (in reverse order!)
    #

    eval printf "%-40.40s %s\n\" \"$1\" \"\${$#}\""
done < $PHONEBOOK
echo "-----"
```

The `listall` program lists all entries in the phone book, printing just the first and last lines of each entry. The internal field separator characters (`IFS`) is set to a `^`, to be used inside the loop. Each line from the file is then read and assigned to the variable `line`. The `set` command assigns each field to the appropriate positional parameter as shown earlier.

The challenge is to get the value of the first and last positional parameters. The first is easy because it can be directly referenced as `$1`. To get the last one, the program taps the power of `eval` as explained in Chapter 12. Specifically, the command

```
eval echo \${$#}
```

displays the value of the last positional parameter. In this particular program, it shows up in the command

```
eval printf "\%-40.40s %-s\n\" \"$1\" \"\${$#}\""
```

This is evaluated, for example, to

```
printf "\%-40.40s %-s\n" "Steve's Ice Cream" "${4}"
```

using the entry shown previously, and then rescanned to substitute the value of `${4}` before executing `printf`.

Sample Output

Now it's time to see how the new, much improved `rolo` works. We'll start with an empty phone book and add a few entries to it. Then we'll list all the entries, look up a friend, then change their entry. To conserve space here in the book, we'll show only the full menu that `rolo` displays the first time.

```
$ PHONEBOOK=/users/steve/misc/book
$ export PHONEBOOK
$ rolo                               Start it up
/users/steve/misc/book does not exist!
Should I create it for you (y/n)? y
```

Would you like to:

1. Look someone up
2. Add someone to the phone book
3. Remove someone from the phone book
4. Change an entry in the phone book
5. List all names and numbers in the phone
6. Exit this program

Please select one of the above (1-6): **2**

Type in your new entry

When you're done, type just a single Enter on the line.

```
>> Steve's Ice Cream
>> 444 6th Avenue
>> New York City 10003
>> 212-555-3021
>>
```

Steve's Ice Cream has been added to the phone book

Would you like to:

...

Please select one of the above (1-6): **2**

Type in your new entry

When you're done, type just a single Enter on the line.

```
>> YMCA
>> 973-555-2344
>>
```

YMCA has been added to the phone book

Would you like to:

...

Please select one of the above (1-6): 2

Type in your new entry

When you're done, type just a single Enter on the line.

```
>> Maureen Connelly
>> Hayden Book Companu
>> 10 Mulholland Drive
>> Hasbrouck Heights, N.J. 07604
>> 201-555-6000
>>
```

Maureen Connelly has been added to the phone book

Would you like to:

...

Please select one of the above (1-6): 2

Type in your new entry

When you're done, type just a single Enter on the line.

```
>> Teri Zak
>> Hayden Book Company
>> (see Maureen Connelly for address)
>> 201-555-6060
>>
```

Teri Zak has been added to the phone book

Would you like to:

...

Please select one of the above (1-6): 5

```
-----
Maureen Connelly          201-555-6000
Steve's Ice Cream        212-555-3021
Teri Zak                  201-555-6060
YMCA                      973-555-2344
-----
```

Would you like to:

...

Please select one of the above (1-6): 1

Enter name to look up: **Maureen**

```
-----  
| Maureen Connelly          |  
| Hayden Book Companu     |  
| 10 Mulholland Drive     |  
| Hasbrouck Heights, NJ 07604 |  
| 201-555-6000           |  
|      o                   o |  
-----
```

```
-----  
| Teri Zak                 |  
| Hayden Book Company     |  
| (see Maureen Connelly for address)|  
| 201-555-6060           |  
|      o                   o |  
-----
```

Would you like to:

...

Please select one of the above (1-6): 4

Enter name to change: **Maureen**

```
-----  
| Maureen Connelly          |  
| Hayden Book Companu     |  
| 10 Mulholland Drive     |  
| Hasbrouck Heights, NJ 07604 |  
| 201-555-6000           |  
|      o                   o |  
-----
```

Change this person (y/n)? **y**

Enter changes with /bin/ed

101

1,\$p

Maureen Connelly

Hayden Book Companu

10 Mulholland Drive

Hasbrouck Heights, NJ 07604

201-555-6000

```
2s/anu/any
```

```
Hayden Book Company
```

```
w
```

```
101
```

```
q
```

```
Would you like to:
```

```
...
```

```
Please select one of the above (1-6): 6
```

```
$
```

Change the misspelling

Hopefully this complex shell programming example offers you some insight into how to develop larger shell programs and how the many different programming tools provided by the system can work together.

Other than shell built-ins, `rolo` relies on `tr`, `grep`, an editor, `sort`, and the standard file system commands such as `mv` and `rm` to get the job done.

The simplicity and elegance that enable you to easily tie all these tools together account for the deserved popularity of the Unix system.

See Appendix B for more information on downloading the `rolo` programs.

Chapter 14 introduces you to interactive features of the shell and two shells that have some nice features not found in the POSIX standard shell.

This page intentionally left blank

Interactive and Nonstandard Shell Features

In this chapter you'll learn about shell features that are useful to interactive users or not part of the POSIX shell standard. These features are available in Bash and the Korn shell, the two most commonly available POSIX-compliant shells across Unix, Linux, and Mac systems.

The Korn shell was developed by David Korn of AT&T Bell Laboratories and was designed to be “upward compatible” with both the System V Bourne shell and the POSIX standard shell. It is now widely available across all major *nix platforms and if you have access to a command line, you probably have `ksh` available to you.

Bash (short for Bourne-Again Shell) was developed by Brian Fox for the Free Software Foundation. It was also designed to be compatible with the System V Bourne shell and the POSIX standard shell, and additionally contains many extensions from the Korn and C shells. Bash is the standard shell on Linux systems and on most modern Unix and Mac systems it has replaced the Bourne shell (in fact, if you are using `sh` you're probably really using `bash` and just don't know it).

Except for a few minor differences, Bash and the Korn shell provide all the POSIX standard shell's features and add many new ones. To give you an idea of the compatibility of these shells with the POSIX standard, all shell programs presented in this book work under both Bash and the Korn shell.

We'll note any non-standard features that we discuss in this chapter, and Table 14.4 at the end of this chapter lists the features supported by the different shells.

Getting the Right Shell

Up to this point we've dropped commands into a file and run it as a shell program without really discussing what shell will actually read the lines and run the program. By default, shell programs are run by your login shell, so it hasn't been a big issue.

It turns out that all the major interactive shells allow you to specify which shell—actually, which program of the thousands included in a Unix or Linux distribution—should be used to run the file. If the first two characters on the first line of a file are `#!`, the remainder of the line specifies an interpreter for the file. So

```
#!/bin/ksh
```

specifies the Korn shell and

```
#!/bin/bash
```

specifies Bash. If you use constructs or notational conventions specific to one shell, you can use this feature to force that shell to run your programs, avoiding compatibility problems.

Since you can specify any program you want, a Perl program beginning with

```
#!/usr/bin/perl
```

forces the shell to invoke `/usr/bin/perl` to interpret the lines within the file.

You have to use this feature with caution, however, because many programs, such as Perl, don't reside in a standard place on every Unix system. Also, this is not specified by the POSIX standard, even though it's found in every modern shell and is even implemented at the operating system level on many Unix versions.

Most commonly you'll see system shell programs use this notation to ensure that Bourne Shell is used regardless of the user's login shell by beginning with

```
#!/bin/sh
```

The ENV File

When you start the shell, one of the first things it does is look in your environment for a variable called `ENV`. If it finds it and it's non-null, the file specified by `ENV` will be executed, much like the `.profile` is executed when logging in. The `ENV` file contains commands to set up the shell's environment. Throughout this chapter, we'll mention various things that you may want to put into this file.

If you do decide to have an `ENV` file, you should set and export the `ENV` variable inside your `.profile` file:

```
$ cat .profile
...
export ENV=$HOME/.alias
...
$
```

Note the shortcut in use above: Instead of assigning the variable a value, then calling `export`, it turns out you can do both on the same line for efficiency.

For Bash users, the `ENV` file is read only when Bash is invoked with the name `sh`, with the `--posix` command-line option, or after `set -o posix` is executed (all of which force POSIX standard compliance). By default, when a non-interactive Bash shell is started (for example, when you run a shell program), it reads commands from the file specified by the `BASH_ENV` environment variable, and when an interactive Bash shell is started (for example, by typing `bash` at the command prompt), it doesn't.

If you're running an older system, you should also export a variable called `SHELL` inside your `.profile` file.

```
$ grep SHELL .profile
SHELL=/bin/ksh ; export SHELL
$
```

This variable is used by certain applications (such as `vi`) to determine what shell to start up when you execute a shell escape. In such cases, you want to make sure that each time you start up a new shell, you get the shell you want and not an older Bourne shell.

Probably, though, `SHELL` will already be set by your login shell. You can test it with

```
$ echo $SHELL
/bin/bash
$
```

Also note that the previous example demonstrates yet another way to set and export a variable, this time by having two separate commands on the same line, separated by a semicolon. Why the inconsistency? Because Unix is so flexible that you'll find it's common for shell programs you read—and users you work with—to accomplish the same task multiple ways. Might as well get used to variations in notation!

Command-Line Editing

Line edit mode is a feature of the shell that allows you to edit a command line in a manner that mimics features found in two popular screen editors. The POSIX standard shell provides the capability to mimic `vi` and both Bash and the Korn shell also support an `emacs` line edit mode. We list the complete set of `vi` commands in Table A.4 in Appendix A.

If you've used either of these screen-based text editors, you'll find that the built-in line editors in the shell are faithful reproductions from a functional perspective. This capability is one of the most useful features in the shell.

To turn on a line edit mode, use the `set` command with the `-o mode` option, where `mode` is either `vi` or `emacs`:

```
$ set -o vi Turn on vi mode
```

Put this in your `.profile` or `ENV` file to automatically start up the shell with one of the edit modes turned on.

Command History

Regardless of which shell you use, it keeps a history of all your previously entered commands. Each time you press the `Enter` key to execute a command, that command gets added to the end of your history list.

Depending on your settings, your command history could even be saved to a file and restored between login sessions, so you can quickly access commands from previous sessions.

By default, the history list is kept in a file in your home directory under the name `.sh_history` (`.bash_history` for Bash). You can change this filename to anything you want by setting the variable `HISTFILE` to the name of your history file. This variable can be set and exported in your `.profile` file.

There is a limit to the number of commands the shell stores. The minimum value is 128 commands but most modern shells save 500 or more of your commands on the list. Each time you log in, the shell automatically truncates your history file to this length.

You can control the size of your history file through the `HISTSIZE` variable. If the default size isn't adequate for your needs, set the `HISTSIZE` variable to a larger value, such as 500 or 1000. The value you assign to `HISTSIZE` can be set and exported in your `.profile` file:

```
$ grep HISTSIZE .profile
HISTSIZE=500
export HISTSIZE
$
```

Don't go crazy with a massive history size, however: The larger the value, the more disk space you will need to store the history file, and the longer it will take the shell to search through the list when you access previous commands.

The `vi` Line Edit Mode

After turning on the `vi` line editor feature, you will be typing all subsequent commands in what `vi` users would think of as *input* mode. You probably won't even notice anything different because you can type in and execute commands exactly the same way that you do with the default shell input prompt:

```
$ set -o vi
$ echo hello
hello
$ pwd
/users/pat
$
```

To make use of the line editor, you must switch to *command* mode by pressing the `ESCAPE` or `Esc` key, usually in the upper-left corner of the keyboard. When you enter command mode, the cursor moves to the left one space, to the last character typed in.

The *current character* is whatever character the cursor is on; we'll say more about the current character in a moment. You can enter vi commands only in command mode and that the commands are interpreted immediately upon typing them in, no Enter needed.

A typical problem you may encounter when typing in long commands is that it's only after typing it all in that you notice an error. Inevitably, the error is at the beginning of the line!

In command mode, you can move the cursor around and fix the errors without disturbing the command line. After you've moved the cursor to the place where the error is, you can change the letter or letters to whatever you want. Then press Enter (regardless of where the cursor is on the line) and it'll be given to the shell for interpretation.

In the following examples, the underline () represents the cursor. A command line will be shown, followed by one or more keystrokes, followed by what the line looks like after applying the keystrokes:

before keystrokes after

First, let's look at moving the cursor around. Many systems will let you use the arrow keys on your keyboard, which makes it easy: left arrow to move left, right arrow to move right.

The more general vi-inspired movement commands, however, are h to move the cursor to the left and the l key moves it to the right. Try this out by entering command mode (press Esc) and pressing the h and l keys a few times. The cursor should move around on the line. If you try to move the cursor past the left or right side of the line, the shell "beeps" at you.

```
$ mary had a little larb      Esc   $ mary had a little larb
$ mary had a little larb      h     $ mary had a little larb
$ mary had a little larb      h     $ mary had a little larb
$ mary had a little larb      l     $ mary had a little larb
```

After the cursor is on the character you want to change, you can use the x command to delete the current character ("X" it out).

```
$ mary had a little larb      x     $ mary had a little lab 
```

Note that the b moved to the left when the r was deleted and is now the current character.

To add characters to the command line, you can use the i or a commands. The i command inserts characters *before* the current character, and the a command adds characters *after* the current character. Both of these commands put you back into input mode, so remember to press Esc to go back to command mode.

```
$ mary had a little lab       im    $ mary had a little lamb 
$ mary had a little lamb      m     $ mary had a little lammb 
$ mary had a little lammb     Esc   $ mary had a little lammb 
$ mary had a little lammb     x     $ mary had a little lamb 
$ mary had a little lamb      a     $ mary had a little lamb 
$ mary had a little lamb      da    $ mary had a little lambda 
```

If you think that moving the cursor around by repeatedly pressing `h` and `l` is slow, you're right. The `h` and `l` commands may be preceded by a number that specifies the number of spaces to move the cursor.

```
$ mary had a little lambda_   Esc   $ mary had a little lambda_
$ mary had a little lambda_   10h   $ mary had a little lambda_
$ mary had a little lambda_   13h   $ mary had a little lambda_
$ mary had a little lambda_   5x    $ had a little lambda_
```

As you see, the `x` command can also be preceded by a number to tell it how many characters to delete.

You can then easily move to the end of the line by typing the `$` command:

```
$ had a little lambda_      $      $ had a little lambda_
```

To move to the beginning of the line, you use the `0` (that's a zero) command:

```
$ had a little lambda_      0      $ had a little lambda_
```

Two other useful cursor movement commands are `w` and `b`. The `w` command moves the cursor forward to the beginning of the next word, where a word is a string of letters, numbers, and underscores delimited by blanks or punctuation. The `b` command moves the cursor backward to the beginning of the previous word. These commands may also be preceded by a number to specify the number of words to move forward or backward.

```
$ had a little lambda_      w      $ had a little lambda_
$ had a little lambda_      2w     $ had a little lambda_
$ had a little lambda_      3b     $ had a little lambda_
```

At any time you can press `Enter` and the current line will be executed as a command.

```
$ had a little lambda_      Hit Enter
ksh: had: not found
$ _
```

After a command is executed, you are placed back in input mode.

Accessing Commands from Your History

So far, you've learned how to edit the current command line. But there's more to `vi` mode because you can use the `vi` commands `k` and `j` to retrieve commands from your history. The `k` command replaces the current line on your terminal with the previously entered command, putting the cursor at the beginning of the line. Let's assume that these commands have just been entered:

```
$ pwd
/users/pat
$ cd /tmp
$ echo this is a test
this is a test
$ _
```

Now go into command mode (Esc) and use `k` to access previous commands from the command history:

```
$ _                               Esc k      $ _echo this is a test
```

Every time `k` is used, the line is replaced by the previous line from the command history, as far back as you want to go, within the constraints set with `HISTSIZE`, as discussed earlier.

```
$ _echo this is a test           k           $ _cd /tmp
$ _cd /tmp                       k           $ _pwd
```

To execute the command being displayed, just press the `Enter` key.

```
$ _pwd                           Hit Enter
/tmp
$ _
```

The `j` command is the reverse of the `k` command and is used to display the next most recent command in the history. In other words, `k` moves you “back” in time, and `j` moves you “forward” in time. Try them a few times and you’ll immediately see what we mean.

The `/` command searches through the command history for a command containing the specified string. If the `/` is entered followed by a string, the shell searches backward through its history to find the most recently executed command that contains that string. The command will then be displayed.

If no line in the history contains the specified string, the shell “beeps” to indicate the error. When the `/` is entered, the current line is replaced by a `.`

```
/tmp
$ _                               Esc /test  /test_
```

The search is begun when the `Enter` key is pressed.

```
/test_                             Enter      $ _echo this is a test
```

To execute the command that results from the search, `Enter` must be pressed again.

```
$ _echo this is a test           Hit Enter again
this is a test
$ _
```

If the command that’s displayed isn’t the one you seek, continue the search by typing in `/` *without* a pattern and pressing `Enter`. The shell is smart enough to use the string that you entered the last time you executed the search command and continue from the last match shown further back in your command list.

When you’ve found the command in the history (either by `k`, `j`, or `/`), you can edit the command using the other `vi` commands we’ve already discussed. Worth noting is that by making these changes, you don’t actually change the command in the history. You’re editing a copy of the command, which will then be entered in the history as the most recent command when you press `Enter`.

Table 14.1 summarizes the basic `vi` line edit commands.

Table 14.1 Basic vi Line Edit Commands

Command	Meaning
h	Move left one character.
l	Move right one character.
b	Move left one word.
w	Move right one word.
0	Move to start of line.
\$	Move to end of line.
x	Delete character at cursor.
dw	Delete word at cursor.
rc	Change character at cursor to <i>c</i> .
a	Enter input mode and enter text after the current character.
i	Enter input mode and insert text before the current character.
k	Get previous command from history.
j	Get next command from history.
/string	Search history for the most recent command containing <i>string</i> ; if <i>string</i> is null, the previous string will be used.

It seems like a lot, but don't get too anxious: *j* and *k* to move up and down your history list, *h* and *l* to move around on the command line, *i* to insert and *Enter* to invoke are all you really need to get going with command line editing in *vi* mode.

The emacs Line Edit Mode

Not a fan of the *vi* visual editor but prefer *emacs*, an editor much beloved by the open source developer community? The shell has a line edit mode for you too. After turning on the *emacs* line editor, you again won't notice anything different because you'll type in and execute commands exactly as before:

```
$ set -o emacs
$ echo hello
hello
$ pwd
/users/pat
$
```

This time, however, to use the *emacs* line editor you will enter *emacs commands*. *emacs* commands are either *control* characters—characters typed in by holding down the *Ctrl* key and pressing another character—or they are characters preceded by the *Esc* key. You may enter

emacs commands any time you want because there are no separate “modes” like the vi line editor. *Note that emacs commands are not followed by an Enter.*

(For a complete list of emacs commands, refer to the documentation for Bash or the Korn shell.)

First, let’s look at how to move the cursor around on the command line. *Ctrl+b* moves the cursor back (to the left), and the *Ctrl+f* command moves it forward (to the right). Try this by pressing *Ctrl+b* and *Ctrl+f* a few times while entering a command on the command line. The cursor should move around on the line. If you try to move the cursor past the left or right side of the line, the shell simply ignores your command.

```
$ mary had a little larb      Ctrl+b      $ mary had a little larb
$ mary had a little larb      Ctrl+b      $ mary had a little larb
$ mary had a little larb      Ctrl+b      $ mary had a little larb
$ mary had a little larb      Ctrl+f      $ mary had a little larb
```

After the cursor is on the character you want to change, you can use the *Ctrl+d* command to delete the current character.

```
$ mary had a little larb      Ctrl+d      $ mary had a little larb
```

Note that the *b* moved to the left when the *r* was deleted and is now the current character.

To add characters to the command line, you simply type them in. The characters are inserted *before* the current character.

```
$ mary had a little larb      m          $ mary had a little larmb
$ mary had a little larmb      m          $ mary had a little larmmb
$ mary had a little larmmb    Ctrl+h     $ mary had a little larmb
```

Note that the current erase character (usually either *Backspace* or *Ctrl+h*) will *always* delete the character to the left of the cursor.

The *Ctrl+a* and *Ctrl+e* commands may be used to move the cursor to the beginning and end of the command line, respectively.

```
$ mary had a little larmb      Ctrl+a     $ mary had a little larmb
$ mary had a little larmb      Ctrl+e     $ mary had a little larmb
```

Note that the *Ctrl+e* command places the cursor one space to the right of the last character on the line. (When you’re not in emacs mode, the cursor is always at the end of the line, one space to the right of the last character typed in.)

This is handy because when you’re at the end of the line, anything you type will be appended to whatever is already on the line.

```
$ mary had a little larmb      da          $ mary had a little larmda
```

Two other useful cursor movement commands are the *Esc f* and *Esc b* commands. The *Esc f* command moves the cursor forward to the end of the current word. The *Esc b* command moves the cursor backward to the beginning of the previous word. Note that for these commands you *press and release* the *Esc* key, *then* press the key that corresponds to the desired command (*f*, *b*, and so on).

```

$ mary had a little lambda_   Esc b           $ mary had a little _lambda
$ mary had a little _lambda   Esc b           $ mary had a _little lambda
$ mary had a _little lambda   Esc b           $ mary had a little lambda
$ mary had a little lambda    Esc f           $ mary had a_little lambda
$ mary had a_little lambda    Esc f           $ mary had a little_lambda

```

You can press the Enter key at any time and the current line will be executed as a command.

```

$ mary had a little_lambda           Hit Enter; enter command
ksh: mary: not found
$ _

```

Accessing Commands from Your History

You've learned how to edit the current command line, but the shell keeps a history of recently entered commands. To access these commands from the history list, use the `emacs` commands `Ctrl+p` and `Ctrl+n`. The `Ctrl+p` command replaces the current line on your terminal with the previously entered command, putting the cursor at the end of the line. `Ctrl+n` does the same action, but with the *next* command in the history list.

Let's assume that these commands have just been entered:

```

$ pwd
/users/pat
$ cd /tmp
$ echo this is a test
this is a test
$ _

```

Now use `Ctrl+p` to access them:

```

$ _                               Ctrl+p           $ echo this is a test_

```

Every time `Ctrl+p` is used, the current line is replaced by the previous line from the command history.

```

$ echo this is a test_           Ctrl+p           $ cd /tmp_
$ cd /tmp_                       Ctrl+p           $ pwd_

```

To execute the command being displayed, just press Enter.

```

$ pwd_                           Hit Enter
/tmp
$ _

```

The `Ctrl+r` command is used to search through the command history for a command containing the specified string. The `Ctrl+r` is entered followed by the search pattern, followed by the Enter key. The shell then searches the command history for the most recently executed command that contains that string. If found, the command line is displayed; otherwise, the shell "beeps."

When the *Ctrl+r* is typed, the shell replaces the current line with the prompt *^R*:

```
$ _          Ctrl+r test  $ ^Rtest_
```

The search is initiated when *Enter* is pressed.

```
$ ^Rtest_          Enter          $ echo this is a test_
```

To execute the command that is displayed as a result of the search, *Enter* must be pressed again.

```
$ echo this is a test_          Hit Enter again
this is a test
$ _
```

To continue the search through the command history, keep typing *Ctrl+r* followed by an *Enter*.

Bash handles *Ctrl+r* a little differently. When you type *Ctrl+r*, Bash replaces the current line with *(reverse-i-search) ` `*:

```
$ _          Ctrl+r          (reverse-i-search) ` `
```

As you type text, the line is updated inside the *` `* with the text you type, and the rest of the line is updated with the matching command:

```
(reverse-i-search) ` `: _          c          (reverse-i-search) `c`: echo this is a
test
(reverse-i-search) `c`: echo this is a test  d          (reverse-i-search) `cd`: cd /tmp
```

Note how Bash highlights the matching part of the command by placing the cursor on it. As with the Korn shell, the command is executed by pressing *Enter*.

When you've found the command in the history (either by *Ctrl+p*, *Ctrl+n*, or *Ctrl+r*), you can also edit the command using the other emacs commands already discussed. As with the vi edit mode, you won't actually change the command in the history but are editing a copy of the command, which will then be entered in the history list when you press *Enter*.

Table 14.2 summarizes the basic emacs line edit commands.

Table 14.2 Basic emacs Line Edit Commands

Command	Meaning
<i>Ctrl+b</i>	Move left one character.
<i>Ctrl+f</i>	Move right one character.
<i>Esc f</i>	Move forward one word.
<i>Esc b</i>	Move back one word.
<i>Ctrl+a</i>	Move to start of line.
<i>Ctrl+e</i>	Move to end of line.
<i>Ctrl+d</i>	Delete current character.

Command	Meaning
Esc d	Delete current word.
<i>erase char</i>	(User-defined erase character, usually # or <i>Ctrl+h</i>), delete previous character.
<i>Ctrl+p</i>	Get previous command from history.
<i>Ctrl+n</i>	Get next command from history.
<i>Ctrl+r string</i>	Search history for the most recent command line containing <i>string</i> .

Other Ways to Access Your History

There are several other ways to access your command history that are worth noting if you don't find that either the *vi* or *emacs* line edit modes work for you.

The `history` Command

The easiest way to access your command history is actually to just type in the command `history`:

```
$ history
507 cd shell
508 cd ch15
509 vi int
510 ps
511 echo $HISTSIZ
512 cat $ENV
513 cp int int.sv
514 history
515 exit
516 cd shell
517 cd ch16
518 vi all
519 run -n5 all
520 ps
521 lpr all.out
522 history
```

The numbers to the left are relative command numbers (command number 1 would be the first, or oldest, command in your history).

Be aware that the `history` command differs between the Korn and Bash shells: The Korn shell `history` command writes your last 16 commands to standard output while Bash will list your *entire* command history, even if it's 500 or 1000 lines long.

If you're running Bash and don't want to be inundated with commands, you can specify the number of commands to display as an argument:

```
$ history 10
513  cp int int.sv
514  history
515  exit
516  cd shell
517  cd ch16
518  vi all
519  run -n5 all
520  ps
521  lpr all.out
522  history 10
$
```

The `fc` Command

The `fc` command allows you to start up an editor on one or more commands from your history or to write a list of history commands to your terminal. In the latter form, which is indicated by giving the `-l` option to `fc`, it is like typing in `history`, only more flexible (you can specify a range of commands to be listed). For example, the command

```
fc -l 510 515
```

writes commands 510 through 515 to standard output, and the command

```
fc -n -1 -20
```

writes the last 20 commands to standard output, but omits the command numbers (`-n`).

Suppose that you've just executed a long command and decide that it would be nice to turn that command line into a shell program called `runx`. You can use `fc` to get the command from your history and I/O redirection to write that command to a file:

```
fc -n -1 -1 > runx
```

That's the letter `l` followed by the number `-1` to get the most recent command (current minus one). `fc` is described in full detail in Appendix A.

The `r` Command

A simple Korn shell command allows you to re-execute previous commands using even fewer keystrokes. Type in the `r` command, and the Korn shell re-executes your last command:

```
$ date
Thu Oct 24 14:24:48 EST 2002
$ r
date
Thu Oct 24 14:25:13 EST 2002
$
```

Re-execute previous command

When you type in the `r` command, the Korn shell redisplay the previous command and then immediately executes it.

If you give `r` the name of a command as an argument, the Korn shell re-executes the most recent command from your history that *begins* with the specified pattern:

```
$ cat docs/planA
...
$ pwd
/users/steve
$ r cat Rerun last cat command
cat docs/planA
$
```

Once again, the Korn shell redisplay the command line from its history before automatically re-executing it.

The final form of the `r` command allows you to substitute the first occurrence of one string with the next. To re-execute the last `cat` command on the file `planB` instead of `planA` you could type:

```
$ r cat planA=planB
cat docs/planB
...
$
```

or even more simply, you could have typed:

```
$ r cat A=B
cat docs/planB
...
$
```

Bash has a similar history shortcut command. `!string` lets you search your history and `!!` re-executes the previous command:

```
$ !!
cat docs/planB
...
$ !d
date
Thu Oct 24 14:39:40 EST 2002
$
```

No spaces can occur between `!` and *string*.

The `fc` command can be used with the `-s` option to do the same thing with any POSIX compliant shell (the `r` command is actually an *alias* to the `fc` command in the Korn shell—more on that later in this chapter):

```
$ fc -s cat
cat docs/planB
...
```

```
$ fc -s B=C
cat docs/planC
...
$
```

Functions

Bash and the Korn shell both have function features not available in the POSIX standard shell. Let's have a look.

Local Variables

Both Bash and Korn shell functions can have local variables, making recursive functions possible. These variables are defined with the `typeset` command, as in

```
typeset i j
```

If a variable of the same name already exists, it is saved when the `typeset` is executed and restored when the function exits.

After using the shell for a while, you may develop a set of functions that you like to use during your interactive work sessions. A good place to define such functions is inside your `ENV` file so that they will be defined whenever you start up a new shell.

Automatically Loaded Functions

The Korn shell allows you to set up a special variable called `FPATH` that is similar to your `PATH` variable. If you try to execute a function that is not yet defined, the Korn shell searches the colon-delimited list of directories in `FPATH` for a file that matches the function name. If it finds such a file, it executes it in the current shell with the expectation that somewhere in the file is a definition for the specified function.

Integer Arithmetic

Both Bash and the Korn shell support evaluating arithmetic expressions without arithmetic expansion. The syntax is similar to `$(...)` but without the dollar sign. Because expansion is not performed, the construct can therefore be used by itself as a command:

```
$ x=10
$ ((x = x * 12))
$ echo $x
120
$
```

The real value of this construct is that it allows arithmetic expressions to be used in `if`, `while`, and `until` commands. The comparison operators set the exit status to a non-zero value if the result of the comparison is false and to a zero value if the result is true. So writing

```
(( i == 100 ))
```

has the effect of testing `i` to see whether it is equal to 100 and setting the exit status appropriately. This makes integer arithmetic ideal for inclusion in `if` conditionals:

```
if (( i == 100 ))
then
    ...
fi
```

The `((i == 100))` returns an exit status of zero (true) if `i` equals 100 and one (false) otherwise, and has the same effect as writing

```
if [ "$i" -eq 100 ]
then
    ...
fi
```

Another advantage of using `((...))` rather than `test` is the ability to perform arithmetic as part of the test:

```
if (( i / 10 != 0 ))
then
    ...
fi
```

Here the comparison returns TRUE if `i` divided by 10 is not equal to zero.

`while` loops can also benefit from integer arithmetic. For example,

```
x=0
while ((x++ < 100))
do
    commands
done
```

executes *commands* 100 times.

Integer Types

Both the Korn and Bash shells support an integer data type. You can declare variables to be integers by using the `typeset` command with the `-i` option

```
typeset -i variables
```

where *variables* are any valid shell variable names. Initial values can also be assigned to the variables at the time they are declared:

```
typeset -i signal=1
```

The main benefit: arithmetic performed on integer variables with the `((...))` construct is faster than on non-integer values.

However, an integer variable cannot be assigned anything but an integer value or integer expression. If you attempt to assign a non-integer to it, the message `bad number` is printed by the shell:

```
$ typeset -i i
$ i=hello
ksh: i: bad number
```

Bash simply ignores any strings that don't contain numeric values and generates an error for anything that contains both numbers and other characters:

```
$ typeset -i i
$ i=hello
$ echo $i
0
$ i=1hello
bash: 1hello: value too great for base (error token is "1hello")
$ i=10+15
$ echo $i
25
$
```

The preceding example also shows that integer-valued expressions can be assigned to an integer variable, without even having to use the `((...))` construct. This holds true for both shells.

Numbers in Different Bases

Both Korn and Bash also allow you to perform arithmetic in different numeric bases. To write a number in a different base with these shells, you use the notation

base#number

For example, to express the value 100 in base 8 (octal) you can write

```
8#100
```

You can write constants in different bases anywhere an integer value is permitted. To assign octal 100 to the integer variable `i`, you can write

```
typeset -i i=8#100
```

Note that with the Korn shell the base of the first value assigned to an integer variable sets the default base of all subsequent uses of that variable. In other words, if the first value you assign to the integer variable `i` is an octal number, each time you reference the value of `i` on the command line, the Korn shell displays it as an octal number using the notation `8#value`.

```
$ typeset -i i=8#100
$ echo $i
8#100
$ i=50
```

```

$ echo $i
8#62
$ (( i = 16#a5 + 16#120 ))
$ echo $i
8#705
$

```

Because the first value assigned to `i` is an octal number (`8#100`), all further references to `i` will also be in octal. When the base 10 value of 50 is next assigned to `i` and then `i` is subsequently displayed, we get the value `8#62`, which is the octal equivalent of 50 in base 10.

There's a subtlety in the above example too: while the display value of `i` is set to octal, the default numeric base for values assigned to the variable remain decimal unless specified otherwise. In other words, `i=50` was *not* equivalent to `i=8#50` even though the shell knew `i` was to be referenced as base 8.

In the preceding example, the `((...))` construct is used to add the two hexadecimal values `a5` and `120`. The result is then displayed, once again in octal. We admit, that's fairly obscure and not likely something you'll encounter in day-to-day shell programming or interactive use!

Bash uses both the `base#number` syntax for arbitrary bases and the C language syntax for octal and hexadecimal numbers—octal numbers are preceded by `0` (zero), and hexadecimal numbers are preceded by `0x`:

```

$ typeset -i i=0100
$ echo $i
64
$ i=0x80
$ echo $i
128
$ i=2#1101001
$ echo $i
105
$ (( i = 16#a5 + 16#120 ))
$ echo $i
453
$

```

Unlike the Korn shell, Bash doesn't keep track of the variable's numeric base; integer variables are displayed as decimal values. You can always use `printf` to print integers in octal or hexadecimal format.

As you can see, with Bash and the Korn shell it's easy to work with different bases which makes it possible to write functions that perform base conversion and non-decimal arithmetic.

No matter the current directory, the `dir` alias prints out `steve`. That's because we weren't careful about quotes when we defined the `dir` alias. Recalling that the shell performs parameter substitution inside double quotes, the problem is that the shell evaluated

```
 ${PWD##*/}
```

at the time the alias was defined. This means that the `dir` alias was essentially defined as if we'd typed in the following:

```
 $ alias dir="echo steve"
```

No wonder it didn't work!

The solution is to use single rather than double quotes when defining the `dir` alias to defer the parameter substitution until the alias is executed:

```
 $ alias dir='echo ${PWD##*/}'           Define alias
 $ pwd                                   Where are we?
 /users/steve
 $ dir                                   Execute alias
 steve
 $ cd letters                            Change directory
 $ dir                                   Execute alias again
 letters
 $ cd /usr/spool                          One more try
 $ dir
 spool
 $
```

If an alias ends with a space, the word following the alias is also checked for alias substitution. For example:

```
 alias nohup="/bin/nohup "
 nohup ll
```

causes the shell to perform alias checking on the string `ll` after replacing `nohup` with `/bin/nohup`.

Quoting a command or prefacing it with a backslash prevents alias substitution. For example:

```
 $ 'll'
 ksh: ll: command not found
 $
```

The format

```
 alias name
```

causes the value of the alias `name` to be listed, and the `alias` command without arguments causes all aliases to be listed.

The following aliases are automatically defined when the Korn shell starts up:

```
autoload='typeset -fu'
functions='typeset -f'
history='fc -l'
integer='typeset -i'
local=typeset
nohup='nohup '
r='fc -e -'
suspend='kill -STOP $$'
```

Note from the preceding example that `r` is actually an alias for the `fc` command with the `-e` option, and `history` is an alias for `fc -l`. By comparison, Bash doesn't automatically define any aliases by default.

Removing Aliases

The `unalias` command is used to remove aliases from the alias list. The format is

```
unalias name
```

which removes the alias *name* and

```
unalias -a
```

which removes all aliases.

If you develop a set of alias definitions that you like to use during your login sessions, you may want to define them inside your `ENV` file so that they will always be available for you to use, as they don't otherwise migrate to subshells.

Arrays

Both Korn and Bash provide a limited array capability. Bash arrays may contain an unlimited number of elements (subject to memory limitations); Korn shell arrays are limited to 4096 elements. Array indexing in both shells starts at zero.

An array element is accessed with a *subscript*, which is an integer-valued expression enclosed within square brackets. You don't declare the maximum size of a shell array either, you simply assign values to elements as needed. The values that you can assign are the same as for ordinary variables:

```
$ arr[0]=hello
$ arr[1]="some text"
$ arr[2]=/users/steve/memos
$
```

To retrieve an element from an array, you need to write the array name followed by an open bracket, the element number and a close bracket. The entire construct must also be

enclosed inside a pair of curly braces, and the whole element is preceded by a dollar sign. Sounds complicated? It's not:

```
$ echo ${array[0]}
hello
$ echo ${array[1]}
some text
$ echo ${array[2]}
/users/steve/memos
$ echo $array
hello
$
```

As you can see from the preceding example, if no subscript is specified, element zero is used.

If you forget the curly braces when performing the substitution, nothing breaks, it just produces a result that's not quite what you expect:

```
$ echo $array[1]
hello[1]
$
```

The value of `array` is substituted (`hello`—the value of `array[0]`) and then echoed along with `[1]`. (Note that because the shell does filename substitution after variable substitution, the shell would attempt to match the pattern `hello[1]` against the files in your current directory.)

The construct `[*]` can be used as a subscript to produce all the elements of an array on the command line, with each element separated by a space.

```
$ echo ${array[*]}
hello some text /users/steve/memos
$
```

The construct `${#array[*]}` can be used to find out the number of elements in `array`.

```
$ echo ${#array[*]}
3
$
```

The number reported is the actual number of values stored within array elements, not the largest subscript used to store an element inside the array.

```
$ array[10]=foo
$ echo ${array[*]}           Display all elements
hello some text /users/steve/memos foo
$ echo ${#array[*]}         Number of elements
4
$
```

An array that has noncontiguous values defined is known as a *sparse array*, in case you've ever heard that phrase before.

You can declare an array of integers by specifying the array name to `typeset -i`:

```
typeset -i data
```

Integer calculations can be performed on array elements using the `((...))` construct:

```
$ typeset -i array
$ array[0]=100
$ array[1]=50
$ (( array[2] = array[0] + array[1] ))
$ echo ${array[2]}
150
$ i=1
$ echo ${array[i]}
50
$ array[3]=array[0]+array[2]
$ echo ${array[3]}
250
$
```

Note that not only can you omit the dollar signs and the curly braces when referencing array elements within double parentheses, you also can omit them outside when the array is declared to be of integer type. Also note that dollar signs are not needed before variables used in subscript expressions.

The following program, called `reverse`, reads lines from standard input and then writes them back to standard output in reverse order:

```
$ cat reverse
# read lines to array buf

typeset -i line=0

while (( line < 4096 )) && read buf[line]
do
    ({ line = line + 1 })
done

# now print the lines in reverse order

while (( line > 0 )) do
    (( line = line - 1 ))
    echo "${buf[line]}"
done

$ reverse
line one
line two
line three
Ctrl+d
line three
line two
line one
$
```

The first `while` loop executes until end of file or 4096 lines have been read (4096 is a Korn shell buffer limit for arrays).

Another example: The `cdh` function defined below changes the current directory but also uses an array to keep a history of previous directories. It allows the user to list the directory history and move back to any directory in the list:

```
$ cat cdh
CDHIST[0]=$PWD                                # initialize CDHIST[0]

cdh ()
{
    typeset -i cdlen i
    if [ $# -eq 0 ] ; then                      # default to HOME with no arguments
        set -- $HOME
    fi

    cdlen=${#CDHIST[*]}                        # number of elements in CDHIST

    case "$@" in
        -l)                                    # print directory list
            i=0
            while ((i < cdlen))
            do
                printf "%3d %s\n" $i ${CDHIST[i]}
                ((i = i + 1))
            done
            return ;;
        -[0-9]|-[0-9][0-9])                    # cd to dir in list
            i=${1#-}                             # remove leading '-'
            cd ${CDHIST[i]} ;;
        *)                                       # cd to new dir
            cd $@ ;;
    esac

    CDHIST[cdlen]=$PWD
}
$
```

The `CDHIST` array stores each directory visited by `cdh`, and the first element, `CDHIST[0]`, is initialized with the current directory when the `cdh` file is run:

```
$ pwd
/users/pat
$ . cdh                                         Define cdh function
$ cdh /tmp
$ cdh -l
    0 /users/pat
    1 /tmp
$
```



```

        set -- $HOME
    fi

    cdlen=${#CDHIST[*]}           # number of elements in CDHIST

    case "$@" in
    -l)                          # print directory list
        i=0
        while ((i < cdlen))
        do
            printf "%3d %s\n" $i ${CDHIST[i]}
            ((i = i + 1))
        done
        return ;;
    -[0-9]|-[0-9][0-9])         # cd to dir in list
        i=${1#-}                # remove leading '-'
        'cd' ${CDHIST[i]} ;;
    *)                          # cd to new dir
        'cd' "$@" ;;
    esac

    CDHIST[cdlen]=${PWD}
}
$ . cdh                        Define cdh function and cd alias
$ cd /tmp
$ cd -l
  0 /users/pat
  1 /tmp
$ cd /usr/spool
$ cd -l
  0 /users/pat
  1 /tmp
  2 /usr/spool
$

```

Table 14.3 summarizes the various array constructs in the Korn shell and Bash.

Table 14.3 Array Constructs

Construct	Meaning
<code>\${array[i]}</code>	Substitute value of element <i>i</i>
<code>\$array</code>	Substitute value of first element (<code>array[0]</code>)
<code>\${array[*]}</code>	Substitute value of all elements
<code>\${#array[*]}</code>	Substitute number of elements
<code>array[i]=val</code>	Store <i>val</i> into <code>array[i]</code>

Job Control

The shell provides facilities for controlling *jobs* directly from the command line. A job is any command or command sequence in the shell. For example:

```
who | wc
```

When a command is started in the background (that is, with `&`), the shell prints out the job number inside brackets (`[]`) as well as the process ID:

```
$ who | wc &
[1]      832
$
```

When a job finishes, the shell prints the message

```
[n] + Done      sequence
```

where *n* is the job number of the finished job, and *sequence* is the text of the command sequence used to create the job.

In its easiest usage, the `jobs` command is used to print the status of jobs that haven't completed.

```
$ jobs
[3] + Running      make ksh &
[2] - Running      monitor &
[1]  Running       pic chapt2 | troff > aps.out &
```

The `+` and `-` after the job number mark the current and previous jobs, respectively. The current job is the job most recently sent to the background, and the previous job is the next-to-the-last job sent to the background. A number of built-in commands may be given a job number or the current or previous job as arguments as a convenient shortcut.

For example, the shell's built-in `kill` command can be used to terminate a job running in the background. The argument to it can be a process ID or a percent sign (`%`) followed by a job number, a `+` (current job), a `-` (previous job), or another `%` (also current job).

```
$ pic chapt1 | troff > aps.out &
[1]      886
$ jobs
[1] + Running       pic chapt1 | troff > aps.out &
$ kill %1
[1]  Done           pic chapt1 | troff > aps.out &
$
```

The preceding `kill` could have used `%+` or `%%` to refer to the same job.

The first few characters of the command sequence can also be used to refer to a job; for example, `kill %pic` would have worked in the preceding example.

```

[1] + Stopped      rundb
$ bg                So put it in the background
[1]      rundb &
...
$ jobs
[1] + Stopped(tty output)      rundb &
$ fg                Bring back to foreground
rundb
1973 Ford      Mustang      red
1975 Chevy     Monte Carlo  green
1976 Ford     Granada      green
1980 Buick     Century      green
1983 Chevy     Cavalier     red
??? find blue      Find blue objects
Ctrl+z        Stop it again
[1] + Stopped      rundb
$ bg                Back to the background
[1]      rundb &
...
Keep working until it's ready

```

Miscellaneous Features

Just a few more tidbits before we wrap up this chapter...

Other Features of the `cd` Command

The `cd` command seems straightforward, but it has a few tricks up its proverbial sleeve. For example, the `-` argument means “the previous directory” as a convenient shortcut:

```

$ pwd
/usr/src/cmd
$ cd /usr/spool/uucp
$ pwd
/usr/spool/uucp
$ cd -                cd to previous directory
/usr/src/cmd          cd prints out name of new directory
$ cd -
/usr/spool/uucp
$

```

As you can see, `cd -` can be used to toggle between two directories with no effort at all.

The Korn shell’s `cd` command has the capability to substitute portions of the current directory’s path. (Neither Bash nor the POSIX standard shell support this feature)

The format is

```
cd old new
```

`cd` attempts to replace the first occurrence of the string *old* in the current directory's path with the string *new*.

```
$ pwd
/usr/spool/uucppublic/pat
$ cd pat steve           Change pat to steve and cd
/usr/spool/uucppublic/steve cd prints out name of new directory
$ pwd                   Confirm location
/usr/spool/uucppublic/steve
$
```

Tilde Substitution

If a word on the command line begins with the tilde `~` character, the shell performs the following substitutions: If the tilde is the only character in the word or if the character following the tilde is a slash `/`, the value of the `HOME` variable is substituted:

```
$ echo ~
/users/pat
$ grep Korn ~/shell/chapter9/ksh
The Korn shell is a new shell developed
by David Korn at AT&T
for the Bourne shell would also run under the Korn
the one on System V, the Korn shell provides you with
idea of the compatibility of the Korn shell with Bourne's,
the Bourne and Korn shells.
The main features added to the Korn shell are:
$
```

If the rest of the word up to a slash is a user's login name in `/etc/passwd`, the tilde and the user's login name are substituted by the `HOME` directory of that user.

```
$ echo ~steve
/users/steve
$ echo ~pat
/users/pat
$ grep Korn -pat/shell/chapter9/ksh
The Korn shell is a new shell developed
by David Korn at AT&T
for the Bourne shell would also run under the Korn
the one on System V, the Korn shell provides you with
idea of the compatibility of the Korn shell with Bourne's,
the Bourne and Korn shells.
The main features added to the Korn shell are:
$
```

In both the Korn and Bash shells, if the `~` is followed by a `+` or a `-`, the value of the variable `PWD` or `OLDPWD` is substituted, respectively. `PWD` and `OLDPWD` are set by `cd` and are the full pathnames

of the current and previous directories, respectively. `~+` and `~-` are not supported by the POSIX standard shell.

```
$ pwd
/usr/spool/uucppublic/steve
$ cd
$ pwd
/users/pat
$ echo ~+
/users/pat
$ echo ~-
/usr/spool/uucppublic/steve
$
```

In addition to the preceding substitutions, the shell also checks for a tilde after a colon `:` and performs tilde substitution on that as well (that’s how you can have something like `~/bin` in your `PATH` and have it work correctly).

Order of Search

It’s worthwhile understanding the search order that the shell uses when you type in a command name:

1. The shell first checks to see whether the command is a reserved word (such as `for` or `do`).
2. If it’s not a reserved word and is not quoted, the shell next checks its alias list, and if it finds a match, performs the substitution. If the alias definition ends in a space, it also attempts alias substitution on the next word. The final result is then checked against the reserved word list, and if it’s not a reserved word, the shell proceeds to step 3.
3. The shell checks the command against its function list and executes the eponymous function if found.
4. The shell checks to see whether the command is a built-in command (such as `cd` and `pwd`).
5. Finally, the shell searches the `PATH` to locate the command.
6. If the command still isn’t found, a “command not found” error message is issued.

Compatibility Summary

Table 14.4 summarizes the compatibility of the POSIX standard shell, the Korn shell, and Bash with the features described in this chapter. In this table, an “X” denotes a supported feature, “UP,” an optional feature in the POSIX shell (these are also known as “User Portability” features in the POSIX shell specification), and “POS” a feature supported only by Bash when it is invoked with the name `sh` or with the `--posix` command-line option, or after `set -o posix` is executed.

Table 14.4 POSIX Shell, Korn Shell, and Bash Compatibility

	POSIX Shell	Korn Shell	Bash
ENV file	X	X	POS
vi line edit mode	X	X	X
emacs line edit mode		X	X
fc command	X	X	X
r command			X
!!			
! <i>string</i>			X
Functions	X	X	X
Local variables		X	X
Autoload via FPATH		X	
Integer expressions with ((...))		X	X
Integer data type		X	X
Integers in different bases		X	X
0x <i>hexnumber</i> , 0 <i>octalnumber</i>			X
Aliases	UP	X	X
Arrays		X	X
Job control	UP	X	X
cd -	X	X	X
cd <i>old new</i>		X	
~ <i>username</i> , ~/	X	X	X
~+, ~-		X	X

A

Shell Summary

This appendix summarizes the main features of the standard POSIX shell as per IEEE Std 1003.1-2001.

Startup

The shell can be given the same options on the command line as can be specified with the `set` command. In addition, the following options can be specified:

- c *commands* *commands* are executed.
- i The shell is interactive. Signals 2, 3, and 15 are ignored.
- s Commands are read from standard input.

Commands

The general format of a command typed to the shell is

command arguments

where *command* is the name of the program to be executed, and *arguments* are its arguments. The command name and the arguments are delimited by *whitespace* characters, normally the space, tab, and newline characters (changing the variable `IFS` affects this).

Multiple commands can be typed on the same line if they're separated by semicolons `;`.

Every command that gets executed returns a number known as the *exit status*; zero is used to indicate success, and non-zero indicates a failure.

The pipe symbol `|` can be used to connect the standard output from one command to the standard input of another, as in

```
who | wc -l
```

The exit status is that of the last command in the pipeline. Placing a `!` at the beginning of the pipeline causes the exit status of the pipeline to be the logical negation of the last command in the pipeline.

If the command sequence is terminated by an ampersand `&`, it is run asynchronously in the background. The shell displays the process ID and job number of the command at the terminal and prompts for the next interactive command to be entered.

Typing of a command can continue to the next line if the last character on the line is a backslash character `\`.

The characters `&&` cause the command that follows to be executed only if the preceding command returns a zero exit status. The characters `||` cause the command that follows to be executed only if the preceding command returns a non-zero exit status. As an example, in

```
who | grep "fred" > /dev/null && echo "fred's logged on"
```

the `echo` is executed only if the `grep` returns a zero exit status.

Comments

If the character `#` appears on a line, the shell treats the remainder of the line as a comment and ignores it for interpretation, substitution and execution.

Parameters and Variables

There are three different types of *parameters*: shell variables, special parameters, and positional parameters.

Shell Variables

A shell variable name must start with an alphabetic or underscore `_` character, and can be followed by any number of alphanumeric or underscore characters. Shell variables can be assigned values on the command line by writing:

```
variable=value variable=value ...
```

Filename substitution is not performed on *value*.

Positional Parameters

Whenever a shell program is executed, the name of the program is assigned to the variable `$0` and the arguments typed on the command line to the variables `$1`, `$2`, ..., respectively. Positional parameters can also be assigned values with the `set` command. Parameters 1 through 9 can be explicitly referenced. Parameters greater than 9 must be enclosed inside braces, as in `${10}`.

Special Parameters

Table A.1 summarizes the special shell parameters.

Table A.1 **Special Parameter Variables**

Parameter	Meaning
\$#	The number of arguments passed to the program; or the number of parameters set by executing the <code>set</code> statement.
\$*	Collectively references all the positional parameters as <code>\$1</code> , <code>\$2</code> ,
\$@	Same as <code>\$*</code> , except when double-quoted (" <code>\$@"</code> ") collectively references all the positional parameters as " <code>\$1</code> ", " <code>\$2</code> ",
\$0	The name of the program being executed.
\$\$	The process ID of the program being executed.
#!	The process ID of the last program sent to the background for execution.
\$?	The exit status of the last command not executed in the background.
\$-	The current option flags in effect (see the <code>set</code> statement).

In addition to these parameters, the shell has some other variables that it uses. Table A.2 summarizes the more important of these variables.

Table A.2 **Other Variables Used by the Shell**

Variable	Meaning
CDPATH	The directories to be searched whenever <code>cd</code> is executed without a full path as argument.
ENV	The name of a file that the shell executes in the current environment when started interactively.
FCEDIT	The editor used by <code>fc</code> . If not set, <code>ed</code> is used.
HISTFILE	If set, specifies a file to be used to store the command history. If not set or if the file isn't writable, <code>\$HOME/.sh_history</code> is used.
HISTSIZE	If set, specifies the number of previously entered commands accessible for editing. The default value is at least 128.
HOME	The user's home directory; the directory that <code>cd</code> changes to when no argument is supplied.
IFS	The internal field separator characters; used by the shell to delimit words when parsing the command line, for the <code>read</code> and <code>set</code> commands, when substituting the output from a back-quoted command, and when performing parameter substitution. Normally, it contains the three characters: space, horizontal tab, and newline.

Variable	Meaning
LINENO	Set by the shell to the line number in the script it is executing. This value is set before the line gets executed and starts at 1.
MAIL	The name of a file that the shell periodically checks for the arrival of mail. If new mail arrives, the shell displays a “You have mail” message. See also MAILCHECK and MAILPATH.
MAILCHECK	The number of seconds specifying how often the shell is to check for the arrival of mail in the file in MAIL or in the files listed in MAILPATH. The default is 600. A value of 0 causes the shell to check before displaying each command prompt.
MAILPATH	A list of files to be checked for the arrival of mail. Each file is delimited by a colon and can be followed by a percent sign % and a message to be displayed when mail arrives in the indicated file. (<code>You have mail</code> is often the default.)
PATH	A colon-delimited list of directories to be searched when the shell needs to find a command to be executed. The current directory is specified as <code>::</code> or <code>:.:</code> (if it heads or ends the list, <code>:</code> suffices).
PPID	The process ID of the program that invoked this shell (that is, the parent process).
PS1	The primary command prompt, normally “ <code>\$</code> ”.
PS2	The secondary command prompt, normally “ <code>></code> ”.
PS4	Prompt used during execution trace (<code>-x</code> option to shell or <code>set -x</code>). Default is “ <code>+ </code> ”.
PWD	Pathname of the current working directory.

Parameter Substitution

In the simplest case, the value of a parameter can be accessed by preceding the parameter with a dollar sign `$`. Table A.3 summarizes the different types of parameter substitution that can be performed. Parameter substitution is performed by the shell before filename substitution and before the command line is divided into arguments.

The presence of the colon after *parameter* in Table A.3 indicates that *parameter* is to be tested to see whether it’s set and non-null. Without the colon, a test is made to check whether *parameter* is set only.

Table A.3 Parameter Substitution

Parameter	Meaning
<code>\$parameter</code> or <code>\${parameter}</code>	Substitute the value of <i>parameter</i> .
<code>\${parameter:-value}</code>	Substitute the value of <i>parameter</i> if it's set and non-null; otherwise, substitute <i>value</i> .
<code>\${parameter-value}</code>	Substitute the value of <i>parameter</i> if it's set; otherwise, substitute <i>value</i> .
<code>\${parameter:=value}</code>	Substitute the value of <i>parameter</i> if it's set and non-null; otherwise, substitute <i>value</i> and also assign it to <i>parameter</i> .
<code>\${parameter=value}</code>	Substitute the value of <i>parameter</i> if it's set; otherwise, substitute <i>value</i> and also assign it to <i>parameter</i> .
<code>\${parameter:?value}</code>	Substitute the value of <i>parameter</i> if it's set and non-null; otherwise, write <i>value</i> to standard error and exit. If <i>value</i> is omitted, write <code>parameter: parameter null or not set</code> instead.
<code>\${parameter?value}</code>	Substitute the value of <i>parameter</i> if it's set; otherwise, write <i>value</i> to standard error and exit. If <i>value</i> is omitted, write <code>parameter: parameter null or not set</code> instead.
<code>\${parameter:+value}</code>	Substitute <i>value</i> if <i>parameter</i> is set and non-null; otherwise, substitute null.
<code>\${parameter+value}</code>	Substitute <i>value</i> if <i>parameter</i> is set; otherwise, substitute null.
<code>\${#parameter}</code>	Substitute the length of <i>parameter</i> . If <i>parameter</i> is <code>*</code> or <code>@</code> , the result is not specified.
<code>\${parameter#pattern}</code>	Substitute the value of <i>parameter</i> with <i>pattern</i> removed from the left side. The smallest portion of the contents of <i>parameter</i> matching <i>pattern</i> is removed. Shell filename substitution characters (<code>*</code> , <code>?</code> , <code>[. . .]</code> , <code>!</code> , and <code>@</code>) may be used in <i>pattern</i> .
<code>\${parameter##pattern}</code>	Same as <code>#pattern</code> except the largest matching <i>pattern</i> is removed.
<code>\${parameter%pattern}</code>	Same as <code>#pattern</code> except <i>pattern</i> is removed from the right side.
<code>\${parameter%%pattern}</code>	Same as <code>##pattern</code> except the largest matching <i>pattern</i> is removed from the right side.

Command Re-entry

The shell keeps a history list of recently entered commands. The number of commands available is determined by the `HISTSIZE` variable (default is typically 128), and the file in which the history is kept is determined by the `HISTFILE` variable (default is `$HOME/.sh_history`). Because the command history is stored in a file, these commands are available after you log off and back on.

There are three ways you can access the command history.

The `fc` Command

The built-in command `fc` allows you to run an editor on one or more commands in the command history. When the edited command is written and you leave the editor, the edited version of the command is then executed. The editor is determined by the `FCEDIT` variable (default `ed`). The `-e` option may be used with `fc` to specify the editor rather than `FCEDIT`.

The `-s` option causes commands to be executed without first invoking an editor. A simple editing capability is built in to the `fc -s` command; an argument of the form

```
old=new
```

may be used to change the first occurrence of the string *old* to the string *new* in the command(s) to be re-executed.

`vi` Line Edit Mode

The shell has a `vi` editor compatible edit mode. When `vi` mode is turned on, you are placed in a state that duplicates `vi`'s *input* mode. You can press the `ESC` key to be placed in *edit* mode, at which point most `vi` commands will be properly interpreted by the shell. The current command line can be edited, as can any of the lines in the command history. Pressing `Enter` at any point in either command or input mode causes the command being edited to be executed.

Table A.4 lists all the editing commands in `vi` mode. Note: [*count*] is an integer and can be omitted.

Table A.4 `vi` Editing Commands

Input Mode Commands	
Command	Meaning
<i>erase</i>	(Erase character, usually <code>Ctrl+h</code> or <code>#</code>); delete previous character.
<code>Ctrl+w</code>	Delete the previous blank-separated word.
<i>kill</i>	(Line kill character, normally <code>Ctrl+u</code> or <code>@</code>); delete the entire current line.
<i>eof</i>	(End-of-file character, normally <code>Ctrl+d</code>); terminate the shell if the current line is empty.

<i>Ctrl+v</i>	Quote next character; editing characters and the erase and kill characters may be entered in a command line or in a search string if preceded by a <i>Ctrl+v</i> .
---------------	--

Enter	Execute the current line.
-------	---------------------------

ESC	Enter edit mode.
-----	------------------

Edit Mode Commands

Command	Meaning
[<i>count</i>]k	Get previous command from history.
[<i>count</i>]-	Get previous command from history.
[<i>count</i>]j	Get next command from history.
[<i>count</i>]+	Get next command from history.
[<i>count</i>]G	Get the command number <i>count</i> from history; the default is the oldest stored command.
/ <i>string</i>	Search history for the most recent command containing <i>string</i> ; if <i>string</i> is null, the previous string will be used (<i>string</i> is terminated by an Enter or a <i>Ctrl+j</i>); if <i>string</i> begins with ^, search for line beginning with <i>string</i> .
? <i>string</i>	Same as / except that the search will be for the least recent command.
n	Repeat the last / or ? command.
N	Repeat the last / or ? command but reverse the direction of the search.
[<i>count</i>]l or	
[<i>count</i>]space	Move cursor right one character.
[<i>count</i>]w	Move cursor right one alphanumeric word.
[<i>count</i>]W	Move cursor right to next blank-separated word.
[<i>count</i>]e	Move cursor to end of word.
[<i>count</i>]E	Move cursor to end of current blank-separated word.
[<i>count</i>]h	Move cursor left one character.
[<i>count</i>]b	Move cursor left one word.
[<i>count</i>]B	Move cursor left to previous blank-separated word.
0	Move cursor to start of line.
^	Move cursor to first nonblank character.
\$	Move cursor to end of line.
[<i>count</i>]	Move cursor to column <i>count</i> ; 1 is default.
[<i>count</i>]fc	Move cursor right to character <i>c</i> .
[<i>count</i>]Fc	Move cursor left to character <i>c</i> .

Command	Meaning
[count]tc	Same as fc followed by h.
[count]Tc	Same as Fc followed by l.
;	Repeats the last f, F, t, or T command.
,	Reverse of ;.
a	Enter input mode and enter text after the current character.
A	Append text to the end of the line; same as \$a.
[count]c motion	Delete current character through character specified by motion and enter input mode; if motion is c, the entire line is deleted.
C	Delete current character through end of line and enter input mode.
S	Same as cc.
[count]d motion	Delete current character through the character specified by motion; if motion is d, the entire line is deleted.
D	Delete current character through the end of line; same as d\$.
i	Enter input mode and insert text before the current character.
I	Enter input mode and insert text before the first word on the line.
[count]P	Place the previous text modification before the cursor.
[count]p	Place the previous text modification after the cursor.
[count]y motion	Copy current character through character specified by motion into buffer used by p and P; if motion is y, the entire line is copied.
Y	Copy current character through the end of line; same as y\$.
R	Enter input mode and overwrite characters on the line.
[count]rc	Replace the current character with c.
[count]x	Delete current character.
[count]X	Delete preceding character.
[count].	Repeat the previous text modification command.
~	Invert the case of the current character and advance the cursor.
[count]_	Append the count word from the previous command and enter input mode; the last word is the default.
	Attempt filename generation on the current word; if a match is found, replace the current word with the match and enter input mode.
=	List files that begin with current word.

<code>\</code>	Complete pathname of current word; if current word is a directory, append a <code>/</code> ; if current word is a file, append a space.
<code>u</code>	Undo the last text modification command.
<code>U</code>	Restore the current line to its original state.
<code>@letter</code>	Soft function key—if an alias of the name <code>_letter</code> is defined, its value will be executed.
<code>[count]v</code>	Executes <code>vi</code> editor on line <code>count</code> ; if <code>count</code> is omitted, the current line is used.
<code>Ctrl+l</code>	Linefeed and print current line.
<code>L</code>	Reprint the current line.
<code>Ctrl+j</code>	Execute the current line.
<code>Ctrl+m</code>	Execute the current line.
<code>Enter</code>	Execute the current line.
<code>#</code>	Insert a <code>#</code> at the beginning of the line and enter the line into the command history (same as <code>I#Enter</code>).

Quoting

Four different types of quoting mechanisms are recognized, as summarized in Table A.5.

Table A.5 Summary of Quotes

Quote	Description
<code>'...'</code>	Removes special meaning of all enclosed characters.
<code>"..."</code>	Removes special meaning of all enclosed characters except <code>\$</code> , <code>'</code> , and <code>\</code> .
<code>\c</code>	Removes special meaning of character <code>c</code> that follows; inside double quotes removes special meaning of <code>\$</code> , <code>'</code> , <code>"</code> , newline, and <code>\</code> that follows, but is otherwise not interpreted; used for line continuation if it appears as last character on line (newline is removed).
<code>'command'</code> or <code>\$(command)</code>	Executes <code>command</code> and inserts standard output at that point.

Tilde Substitution

Each word and shell variable on a command line is checked to see whether it begins with an unquoted `~`. If it does, the rest of the word or variable up to a `/` is considered a login name and is looked up in a system file, typically `/etc/passwd`. If that user exists, their home directory replaces the `~` and the login name. If that user doesn't exist, the text is unchanged. A `~` by itself or followed by a `/` is replaced by the `HOME` variable.

Arithmetic Expressions

General Format: `$((expression))`

The shell evaluates the integer arithmetic *expression*. *expression* can contain constants, shell variables (which don't have to be preceded by dollar signs), and operators. The operators, in order of decreasing precedence, are

-	unary minus
~	bitwise NOT
!	logical negation
* / %	multiplication, division, remainder
+ -	addition, subtraction
<< >>	left shift, right shift
<= >= < >	comparison
== !=	equal, not equal
&	bitwise AND
^	bitwise exclusive OR
	bitwise OR
&&	logical AND
	logical OR
<code>expr₁ ? expr₂ : expr₃</code>	conditional operator
=, *=, /=, %=	assignment
+=, <<=, >>=,	
&=, ^=, =	

Parentheses may be used to override operator precedence.

The exit status is zero (true) if the last expression is nonzero and one (false) if the last expression is zero.

The C operators `sizeof`, `++`, and `--` may be available in your shell implementation but are not required by the standard. Check by typing `sizeof` and see what happens.

Examples

```
y=$(22 * 33)
z=$((y * y / (y - 1)))
```

Filename Substitution

After parameter substitution and command substitution are performed on the command line, the shell looks for the special characters `*`, `?`, and `[]`. If they're not quoted, the shell searches the current directory, or another directory if preceded by a `/`, and substitutes the names of all files that match. If no match is found, the characters remain untouched.

Note that filenames beginning with a `.` must be explicitly matched (in other words, `echo *` won't display your hidden files but `echo .*` will).

The filename substitution characters are summarized in Table A.6.

Table A.6 **Filename Substitution Characters**

Character(s)	Meaning
<code>?</code>	Matches any single character.
<code>*</code>	Matches zero or more characters.
<code>[chars]</code>	Matches any single character in <i>chars</i> ; the format C_1-C_2 can be used to match any character in the range C_1 through C_2 , inclusive (for example, <code>[A-Z]</code> matches any uppercase letter).
<code>[!chars]</code>	Matches any single character <i>not</i> in <i>chars</i> ; a range of characters may be specified as above.

I/O Redirection

When scanning the command line, the shell looks for the special redirection characters `<` and `>`. If found, they are processed and removed (with any associated arguments) from the command line. Table A.7 summarizes the different types of I/O redirection that the shell supports.

Table A.7 **I/O Redirection**

Construct	Meaning
<code>< file</code>	Redirect standard input from <i>file</i> .
<code>> file</code>	Redirect standard output to <i>file</i> ; <i>file</i> is created if it doesn't exist and zeroed if it does.
<code>> file</code>	Redirect standard output to <i>file</i> ; <i>file</i> is created if it doesn't exist and zeroed if it does; the <code>noclobber (-C)</code> option to <code>set</code> is ignored.
<code>>> file</code>	Like <code>></code> , except that output is appended to <i>file</i> if it already exists.
<code><< word</code>	Redirect standard input from lines that follow up until a line containing just <i>word</i> ; parameter substitution occurs on the lines, and back-quoted commands are executed and the backslash character interpreted; if any character in <i>word</i> is quoted, none of this processing occurs and the lines are passed through unaltered; if <i>word</i> is preceded by a <code>-</code> , leading tabs on the lines are removed.
<code><& digit</code>	Standard input is redirected from the file associated with file descriptor <i>digit</i> .

Construct	Meaning
>& <i>digit</i>	Standard output is redirected to the file associated with file descriptor <i>digit</i> .
<&-	Standard input is closed.
>&-	Standard output is closed.
<> <i>file</i>	Open <i>file</i> for both reading and writing.

Note that filename substitution is not performed on *file*. Any of the constructs listed in the first column of the table may be preceded by a file descriptor number to have the same effect on the file associated with that file descriptor.

The file descriptor 0 is associated with standard input, 1 with standard output, and 2 with standard error.

Exported Variables and Subshell Execution

Commands other than the shell's built-in commands are normally executed in a new instantiation of the shell called a *subshell*. Subshells cannot change the values of variables in the parent shell, and they can only access variables from the parent shell that were *exported*—either implicitly or explicitly—by the parent. If the subshell changes the value of one of these variables and wants to have its own subshells know about it, it must explicitly export the variable before executing the subshell.

When the subshell finishes execution, any variables that it may have set are inaccessible by the parent.

The (...) Construct

If one or more commands are placed inside parentheses, those commands will be executed in a subshell.

The { ...; } Construct

If one or more commands are placed inside curly braces, those commands will be executed by the *current* shell.

With this construct and the (...) construct, I/O can be redirected and piped into and out of the set of enclosed commands, and the set can be sent to the background for execution by placing an & at the end. For example,

```
(prog1; prog2; prog3) 2>errors &
```

submits the three listed programs to the background for execution, with standard error from all three programs redirected to the file `errors`.

More on Shell Variables

A shell variable can be placed into the environment of a command by preceding the command name with the assignment to the parameter on the command line, as in

```
PHONEBOOK=$HOME/misc/phone rolo
```

Here the variable `PHONEBOOK` will be assigned the indicated value and then placed in `rolo`'s environment. The environment of the current shell remains unchanged, as if

```
(PHONEBOOK=$HOME/misc/phone; export PHONE BOOK; rolo)
```

had been executed instead.

Functions

Functions take the following form:

```
name () compound-command
```

where *compound-command* is a set of commands enclosed in `(...)`, `{...}` or can be a `for`, `case`, `until`, or `while` command. Most often, the function definition takes this form:

```
name () { command; command; ...command; }
```

where *name* is the name of the function defined to the *current* shell (functions can't be exported). The function definition can span as many lines as needed. A `return` command can be used to cause execution of the function to be terminated without also terminating the shell (see the `return` command description).

For example,

```
nf () { ls | wc -l; }
```

defines a function called `nf` to count the number of files in your current directory.

Job Control

Shell Jobs

Every command sequence run in the background is assigned a job number, starting at one. A job can be referenced by a *job_id*, which is a `%` followed by the job number, `%, %-`, `%%`, `%` followed by the first few letters of the pipeline, or `??string`.

The following built-in commands can be given a *job_id* as an argument: `kill`, `fg`, `bg`, and `wait`. The special conventions `%+` and `%-` refer to the current and previous jobs, respectively; `%%` also refers to the current job. The current job is the most recent job placed in the background or the job running in the foreground. The convention `%string` refers to the job whose name begins with *string*; `??string` refers to the job whose name contains *string*. The `jobs` command may be used to list the status of all currently running jobs.

If the `monitor` option of the `set` command is turned on, the shell prints a message when each job finishes. If you still have jobs when you try to exit the shell, a message is printed to alert you of this. If you immediately try to exit again, the shell exits. The `monitor` option is enabled by default for interactive shells.

Stopping Jobs

If the shell is running on a system with job control, and the `monitor` option of the `set` command is enabled, jobs that are running in the foreground may be placed in the background and vice versa. Normally, `Ctrl+z` stops the current job and the `bg` command puts a stopped job in the background. The `fg` command brings a background or stopped job to the foreground.

Whenever a job in the background attempts to read from the terminal, it is stopped until it is brought to the foreground. Output from background jobs normally comes to the terminal. If `stty tostop` is executed, output from background jobs is disabled, and a job writing to the terminal is stopped until it is brought to the foreground. When the shell exits, all stopped jobs are killed.

Command Summary

This section summarizes the shell's built-in commands. Actually, some of these commands (such as `echo` and `test`) may not be built in to the shell or might have a streamlined version built-in and a more sophisticated version as a separate program. In all cases, these functions must be provided as a utility by a POSIX-compliant system. They are built in to Bash and the Korn shell and are used in almost all shell scripts.

The `:` Command

General Format: `:`

This is essentially a *null* command. It is frequently used to satisfy the requirement that a command appear.

Example

```
if who | grep jack > /dev/null ; then
:
else
    echo "jack's not logged in"
fi
```

The `:` command returns an exit status of zero.

The `.` Command

General Format: `. file`

The “dot” command causes the indicated file to be read and executed by the shell, just as if the lines from the file were typed at that point. Note that *file* does not have to be executable, only readable. Also, the shell uses the `PATH` variable to find *file*.

Example

```
. progdefs           Execute commands in progdefs
```

The preceding command causes the shell to search the current `PATH` for the file `progdefs`. When it finds it, it reads and executes the commands from the file.

Note that because *file* is not executed by a subshell, variables set and/or changed within *file* remain in effect after execution of the commands in *file* is complete.

The alias Command

General Format: `alias name=string [name=string ...]`

The `alias` command assigns *string* to the alias *name*. Whenever *name* is used as a command, the shell substitutes *string*, performing command-line substitution after *string* is in place.

Examples

```
alias ll='ls -l'
alias dir='basename $(pwd)'
```

If an alias ends with a blank, the word following the alias is also checked to see whether it’s an alias.

The format

```
alias name
```

causes the alias for *name* to be printed out.

`alias` with no arguments lists all aliases.

`alias` returns an exit status of zero unless a *name* is given (as in `alias name`) for which no alias has been defined.

The bg Command

General Format: `bg job_id`

If job control is enabled, the job identified by *job_id* is put into the background. If no argument is given, the most recently suspended job is put into the background.

Example

```
bg %2
```

The `break` Command

General Format: `break`

Execution of this command causes execution of the innermost `for`, `while`, or `until` loop to be immediately terminated. Execution continues with the commands that immediately follow the loop.

If the format

```
break n
```

is used, execution of the n innermost loops is automatically terminated.

The `case` Command

General Format:

```
case value in
    pat1) command
           command
           ...
           command;;
    pat2) command
           command
           ...
           command;;
    ...
    patn) command
           command
           ...
           command;;
esac
```

The word `value` is successively compared against `pat1`, `pat2`, ..., `patn` until a match is found. The commands that appear immediately after the matching pattern are then executed until a double semicolon (`;;`) is encountered. At that point, execution of the `case` is terminated.

If no pattern matches `value`, none of the commands inside the `case` are executed. The pattern `*` matches *anything* and is often used as the last pattern in a `case` as the default or “catch-all” case.

The shell metacharacters

`*` (match zero or more characters),

`?` (match any single character), and

`[...]` (match any single character enclosed between the brackets)

can be used in patterns. The character `|` can be used to specify a logical ORing of two patterns, as in

pat_1 | pat_2

which means to match either pat_1 or pat_2 .

Examples

```
case $1 in
  -l) lopt=TRUE;;
  -w) wopty=TRUE;;
  -c) copt=TRUE;;
  *) echo "Unknown option";;
esac
case $choice in
  [1-9]) valid=TRUE;;
  *) echo "Please choose a number from 1-9";;
esac
```

The cd Command

General Format: `cd directory`

Execution of this command causes the shell to make *directory* the current directory. If *directory* is omitted, the shell makes the directory specified in the HOME variable the current directory.

If the shell variable CDPATH is null, *directory* must be a full directory path (for example, /users/steve/documents) or specified relative to the current directory (for example, documents or ../pat).

If CDPATH is non-null and *directory* is not a full path, the shell searches the colon-delimited directory list in CDPATH for a directory containing *directory*.

Examples

```
$ cd documents/memos      Change to documents/memos directory
$ cd                      Change to HOME directory
```

An argument of - causes the shell to move the user back to the previous directory. The pathname of the new current directory is printed out.

Examples

```
$ pwd
/usr/lib/uucp
$ cd /
$ cd -
/usr/lib/uucp
$
```

The `cd` command sets the shell variable PWD to the new current directory, and OLDPWD to the previous directory.

The `continue` Command

General Format: `continue`

Execution of this command from within a `for`, `while`, or `until` loop causes any commands that follow the `continue` to be skipped. Execution of the loop then continues as normal.

If the format

```
continue n
```

is used, the commands within the `n` innermost loops are skipped. Execution of the loops then continues as normal.

The `echo` Command

General Format: `echo args`

This command causes `args` to be written to standard output. Each word from `args` is delimited by a blank space. A newline character is written at the end. If `args` is omitted, the effect is to simply skip a line.

Certain backslashed characters have a special meaning to `echo` as shown in Table A.8.

Table A.8 `echo` Escape Characters

Character	Prints
<code>\a</code>	Alert
<code>\b</code>	Backspace
<code>\c</code>	The line without a terminating newline
<code>\f</code>	Formfeed
<code>\n</code>	Newline
<code>\r</code>	Carriage return
	Tab character
<code>\v</code>	Vertical tab character
<code>\\</code>	Backslash character
<code>\0nnn</code>	The character whose ASCII value is <code>nnn</code> , where <code>nnn</code> is a one- to three-digit octal number that starts with a zero

Remember to quote these characters so that the `echo` command, rather than the shell, interprets them.

The `exit` Command

General Format: `exit n`

Execution of `exit` causes the current shell program to be immediately terminated. The exit status of the program is the value of the integer `n`, if supplied. If `n` is not supplied, the exit status is that of the last command executed prior to the `exit`.

An exit status of zero is used to indicate success, and non-zero to indicate failure (such as an error condition). This convention is used by the shell in evaluation of conditions for `if`, `while`, and `until` commands, and with the `&&` and `||` constructs.

Examples

```
who | grep $user > /dev/null
exit                               Exit with status of last grep
exit 1                             Exit with status of 1
if finduser                         If finduser returns an exit status of zero then...
then
    ...
fi
```

Note that executing `exit` directly from a login shell has the effect of logging you off.

The `export` Command

General Format: `export variables`

The `export` command tells the shell that the indicated variables are to be marked as exported; that is, their values are to be passed down to subshells.

Examples

```
export PATH PS1
export dbhome x1 y1 date
```

Variables may be set when exported using the form

```
export variable=value...
```

So lines such as

```
PATH=$PATH:$HOME/bin; export PATH
CDPATH=.:$HOME:/usr/spool/uucppublic; export CDPATH
```

can be rewritten as

```
export PATH=$PATH:$HOME/bin CDPATH=.:$HOME:/usr/spool/uucppublic
```

The output of `export` with a `-p` argument is a list of the exported variables and their values in the form

```
export variable=value
```

or

`export variable`

if `variable` has been exported but does not yet have its value set.

The `false` Command

General Format: `false`

The `false` command returns a nonzero exit status.

The `fc` Command

General Format: `fc -e editor -lnr first last`

`fc -s old=new first`

The `fc` command is used to edit commands in the command history. A range of commands is specified from `first` to `last`, where `first` and `last` can be either command numbers or strings; a negative number is taken as an offset from the current command number, while a string specifies the most recently entered command beginning with that string. The commands are read into the editor and executed upon exit from the editor. If no editor is specified, the value of the shell variable `FCEDIT` is used; if `FCEDIT` is not set, `ed` is used.

The `-l` option lists the commands from `first` to `last` (that is, an editor is not invoked). If the `-n` option is also selected, these commands are not preceded by command numbers.

The `-r` option to `fc` reverses the order of the commands.

If `last` is not specified, it defaults to `first`. If `first` is also not specified, it defaults to the previous command for editing and to `-16` for listing.

The `-s` option causes the selected command to be executed without editing it first. The format

`fc -s old=new first`

causes the command `first` to be re-executed after the string `old` in the command is replaced with `new`. If `first` isn't specified, the previous command is used, and if `old=new` isn't specified, the command is not changed.

Examples

<code>fc -l</code>	<i>List the last 16 commands</i>
<code>fc -e vi sed</code>	<i>Read the last <code>sed</code> command into <code>vi</code></i>
<code>fc 100 110</code>	<i>Read commands 100 to 110 into <code>\$FCEDIT</code></i>
<code>fc -s</code>	<i>Re-execute the previous command</i>
<code>fc -s abc=def 104</code>	<i>Re-execute command 104, replacing <code>abc</code> with <code>def</code></i>

The fg Command

General Format: `fg job_id`

If job control is enabled, the job specified by `job_id` is brought to the foreground. If no argument is given, the most recently suspended job or the job last sent to the background is brought to the foreground.

Example

```
fg %2
```

The for Command

General Format:

```
for var in word1 word2 ... wordn
do
    command
    command
    ...
done
```

Execution of this command causes the commands enclosed between the `do` and `done` to be executed as many times as there are words listed after the `in`.

The first time through the loop, the first word—`word1`—is assigned to the variable `var` and the commands between the `do` and `done` executed. The second time through the loop, the second word listed—`word2`—is assigned to `var` and the commands in the loop executed again.

This process continues until the last variable in the list—`wordn`—is assigned to `var` and the commands between the `do` and `done` executed. At that point, execution of the `for` loop is terminated. Execution then continues with the command that immediately follows the `done`.

The special format

```
for var
do
    ...
done
```

indicates that the positional parameters “`$1`”, “`$2`”, ... are to be used in the list and is equivalent to

```
for var in "$@"
do
    ...
done
```

Example

```
# nroff all of the files in the current directory
for file in *
```

```
do
  nroff -Tlp $file | lp
done
```

The getopt Command

General Format: `getopts options var`

This command processes command-line arguments. *options* is a list of valid single letter options. If any letter in *options* is followed by a `:`, that option requires an additional argument on the command line which must be separated from the option by at least one space.

Each time `getopts` is called, it processes the next command-line argument. If a valid option is found, `getopts` stores the matching option letter inside the specified variable *var* and returns a zero exit status.

If an invalid option is specified (one not listed in options), `getopts` stores a `?` inside *var* and returns with a zero exit status. It also writes an error message to standard error.

If an option takes an argument, `getopts` stores the matching option letter inside *var* and stores the command-line argument inside the special variable `OPTARG`. If no arguments are left on the command line, `getopts` sets *var* to `?` and writes an error message to standard error.

If no more options remain on the command line (if the next command-line argument does not begin with a `-`), `getopts` returns a nonzero exit status.

The special variable `OPTIND` is also used by `getopts`. It is initially set to 1 and is adjusted each time `getopts` returns to indicate the number of the next command-line argument to be processed.

The argument `--` can be placed on the command line to specify the end of the command-line arguments.

`getopts` supports stacked arguments, as in

```
repx -ia
```

which is equivalent to

```
repx -i -a -u
```

Options that have required arguments may not be stacked.

If the format

```
getopts options var args
```

is used, `getopts` parses the arguments specified by *args* rather than the command-line arguments.

Example

```
usage="Usage: foo [-r] [-O outfile] infile"
```

```
while getopts ro: opt
```

```

do
    case "$opt"
    in
        r) rflag=1;;
        O) oflag=1
           ofile=$OPTARG;;
        \?) echo "$usage"
           exit 1;;
    esac
done

if [ $OPTIND -gt $# ]
then
    echo "Needs input file!"
    echo "$usage"
    exit 2
fi

shift=$((OPTIND - 1))
ifile=$1
...

```

The hash Command

General Format: hash *commands*

This command tells the shell to look for the specified commands and to remember what directories they are located in. If *commands* is not specified, a list of the hashed commands is displayed.

If the format

```
hash -r
```

is used, the shell removes all commands from its hash list. Next time any command is executed, the shell uses its normal search methods to find the command.

Examples

```

hash rollo whoq           Add rollo and whoq to hash list
hash                     Print hash list
hash -r                   Remove hash list

```

The if Command

General Format:

```

if commandt
then

```

```

        command
        command
    ...
fi

```

`commandt` is executed and its exit status tested. If it is zero, the commands that follow up to the `fi` are executed. Otherwise, the commands that follow up to the `fi` are skipped.

Example

```

if grep $sys sysnames > /dev/null
then
    echo "$sys is a valid system name"
fi

```

If the `grep` returns an exit status of zero (which it will if it finds `$sys` in the file `sysnames`), the `echo` command is executed; otherwise it is skipped.

The built-in command `test` is often used as the command following the `if`, either by explicitly calling `test` or using its mnemonic shortcut `[`, the latter of which requires a matching `]`.

Example

```

if [ $# -eq 0 ] ; then
    echo "Usage: $0 [-l] file ..."
    exit 1
fi

```

An `else` clause can be added to the `if` to be executed if the command returns a nonzero exit status. In this case, the general format of the `if` becomes

```

if commandt
then
    command
    command
    ...
else
    command
    command
    ...
fi

```

If `commandt` returns an exit status of zero, the commands that follow up to the `else` are executed, and the commands between the `else` and the `fi` are skipped. Otherwise, `commandt` returns a nonzero exit status and the commands between the `then` and the `else` are skipped, and the commands between the `else` and the `fi` are executed.

Example

```

if [ -z "$line" ]
then
    echo "I couldn't find $name"

```

```

else
    echo "$line"
fi

```

In the preceding example, if `line` has zero length, the `echo` command that displays the message `I couldn't find $name` is executed; otherwise, the `echo` command that displays the value of `line` is executed.

A final format of the `if` command is useful when more than a two-way decision has to be made. Its general format is

```

if command1
then
    command
    command
    ...
elif command2
then
    command
    command
    ...
elif commandn
then
    command
    command
    ...
else
    command
    command
    ...
fi

```

`command`₁, `command`₂, ..., `command`_{*n*} are evaluated in order until one of the commands returns an exit status of zero, at which point the commands that immediately follow the `then` (up to another `elif`, `else`, or `fi`) are executed. If none of the commands returns an exit status of zero, the commands listed after the `else` (if present) are executed.

Example

```

if [ "$choice" = a ] ; then
    add $*
elif [ "$choice" = d ] ; then
    delete $*
elif [ "$choice" = l ] ; then
    list
else
    echo "Bad choice!"
    error=TRUE
fi

```

The jobs Command

General Format: jobs

The list of active jobs is printed. If the `-l` option is specified, detailed information about each job, including its process ID, is listed as well. If the `-p` option is specified, only process IDs are listed.

If an optional *job_id* is supplied to the jobs command, just information about that job is listed.

Example

```
$ sleep 100 &
[1] 1104
$ jobs
[1] + Running          sleep 100 &
$
```

The kill Command

General Format: kill -*signal* *job*

The kill command sends the signal *signal* to the specified process, where *job* is a process ID or *job_id*, and *signal* is a number or one of the signal names specified in `<signal.h>` (see the description of `trap` later in the chapter). `kill -l` lists these names. A signal number supplied with the `-l` option lists the corresponding signal name. A process ID used with the `-l` option lists the name of the signal that terminated the specified process (if it was terminated by a signal).

The `-s` option can also be used when a signal name is supplied, in which case the dash before the name is not used (see the following example).

If *signal* isn't specified, `SIGTERM` (`TERM`) is used.

Examples

```
kill -9 1234
kill -HUP %2 3456
kill -s TERM %2
kill %1
```

Note that more than one process ID can be supplied to the kill command on the command line.

The newgrp Command

General Format: newgrp *group*

This command changes your real group id (GID) to *group*. If no argument is specified, it changes you back to your default group.

Examples

```
newgrp shbook      Change to group shbook
newgrp             Change back to default group
```

If a password is associated with the new group, and you are not listed as a member of the group, you will be prompted to enter it.

`newgrp -l` changes you back to your login group.

The `pwd` Command

General Format: `pwd`

This command tells the shell to print your working directory, which is written to standard output.

Examples

```
$ pwd
/users/steve/documents/memos
$ cd
$ pwd
/users/steve
$
```

The `read` Command

General Format: `read vars`

This command causes the shell to read a line from standard input and assign successive whitespace-delimited words from the line to the variables `vars`. If fewer variables are listed than there are words on the line, the additional words are stored in the last variable.

Specifying just one variable has the effect of reading and assigning an entire line to the variable.

The exit status of `read` is zero unless an end-of-file condition is encountered.

Examples

```
$ read hours mins
10 19
$ echo "$hours:$mins"
10:19
$ read num rest
39 East 12th Street, New York City 10003
$ echo "$num\n$rest"
39
East 12th Street, New York City 10003
```

```
$ read line
    Here    is an entire        line \r
$ echo "$line"
Here    is an entire        line r
$
```

Note in the final example that any leading whitespace characters get “eaten” by the shell when read. You can change `IFS` if this poses a problem.

Also note that backslash characters get interpreted by the shell when you read the line, and any that make it through (double backslashes will get through as a single backslash) get interpreted by `echo` if you display the value of the variable.

A `-r` option to `read` says to not treat a `\` character at the end of a line as line continuation.

The readonly Command

General Format: `readonly vars`

This command tells the shell that the listed variables cannot be assigned values. These variables may be optionally assigned values on the `readonly` command line. If you subsequently try to assign a value to a `readonly` variable, the shell issues an error message.

`readonly` variables are useful for ensuring that you don’t accidentally overwrite the value of a variable. They’re also good for ensuring that other people using a shell program can’t change the values of particular variables (for example, their `HOME` directory or their `PATH`). The `readonly` attribute is not passed down to subshells.

`readonly` with a `-p` option prints a list of your `readonly` variables.

Example

```
$ readonly DB=/users/steve/database    Assign value to DB and make it readonly
$ DB=foo                                Try to assign it a value
sh: DB: is read-only                    Error message from the shell
$ echo $DB                               But can still access its value
/users/steve/database
$
```

The return Command

General Format: `return n`

This command causes the shell to stop execution of the current function and immediately return to the caller with an exit status of `n`. If `n` is omitted, the exit status returned is that of the command executed immediately prior to the `return`.

The `set` Command

General Format: `set options args`

This command is used to turn on or off options as specified by *options*. It is also used to set positional parameters, as specified by *args*.

Each single letter option in *options* is enabled if the option is preceded by a minus sign `-`, or disabled if preceded by a plus sign `+`. Options can be grouped, as in

```
set -fx
```

which enables the `f` and `x` options.

Table A.9 summarizes the options that can be selected.

Table A.9 `set` Options

Meaning	Option
--	Don't treat subsequent <i>args</i> preceded by a <code>-</code> as options. If there are no arguments, the positional parameters are unset.
-a	Automatically export all variables that are subsequently defined or modified.
-b	If supported by the implementation, causes the shell to notify you when background jobs finish.
-C	Don't allow output redirection to overwrite existing files. <code>> </code> can still be used to force individual files to be overwritten even if this option is selected.
-e	Exit if any command that gets executed fails or has a nonzero exit status.
-f	Disable filename generation.
-h	Add commands inside functions to the hash list as they are defined, and not as they are executed.
-m	Turn on the job monitor.
-n	Read commands without executing them (useful for checking for balanced <code>do...done</code> s, and <code>if ... fi</code> s).
+o	Write current option mode settings in command format.
-o <i>m</i>	Turn on option mode <i>m</i> (see Table A.10).
-u	Issue an error if a variable is referenced without having been assigned a value or if a positional parameter is referenced without having been set.
-v	Print each shell command line as it is read.
-x	Print each command and its arguments as it is executed, preceded by a <code>+</code> .

Shell modes are turned on or off by using the `-o` and `+o` options, respectively, followed by an option name. These options are summarized in Table A.10.

Table A.10 **Shell Modes**

Mode	Meaning
<code>allexport</code>	Same as <code>-a</code> .
<code>errexit</code>	Same as <code>-e</code> .
<code>ignoreeof</code>	The exit command must be used to leave the shell.
<code>monitor</code>	Same as <code>-m</code> .
<code>noclobber</code>	Same as <code>-C</code> .
<code>noexec</code>	Same as <code>-n</code> .
<code>noglob</code>	Same as <code>-f</code> .
<code>nolog</code>	Don't put function definitions in the history.
<code>nounset</code>	Same as <code>-u</code> .
<code>verbose</code>	Same as <code>-v</code> .
<code>vi</code>	The in-line editor is set to <code>vi</code> .
<code>xtrace</code>	Same as <code>-x</code> .

The command `set -o` without any options has the effect of listing all shell modes and their current settings.

The shell variable `$-` contains the current options setting.

Each word listed in `args` is set to the positional parameters `$1`, `$2`, ..., respectively. If the first word might start with a minus sign, it's safer to specify the `--` option to `set` to avoid interpretation of that value.

If `args` is supplied, the variable `$#` will be set to the number of parameters assigned after execution of the command.

Examples

```
set -vx Print all command lines as they are read,
and each command and its arguments as
it is executed

set "$name" "$address" "$phone" Set $1 to $name, $2 to $address, and $3 to
$phone

set -- -1 Set $1 to -1

set -o vi Turn on vi mode

set +o verbose -o noglob Turn verbose mode off, noglob on
```

The `shift` Command

General Format: `shift`

This command causes the positional parameters `$1`, `$2`, ..., `$n` to be “shifted left” one place. That is, `$2` is assigned to `$1`, `$3` to `$2`, ..., and `$n` to `$n-1`. `$#` is adjusted accordingly.

If the format

```
shift n
```

is used instead, the shift is to the left `n` places.

Examples

```
$ set a b c d
$ echo "$#\n$"
4
a b c d
$ shift
$ echo "$#\n$"
3
b c d
$ shift 2
$ echo "$#\n$"
1
d
$
```

The `test` Command

General Format:

```
test condition
```

or

```
[ condition ]
```

The shell evaluates *condition* and if the result of the evaluation is *TRUE*, returns a zero exit status. If the result of the evaluation is *FALSE*, a nonzero exit status is returned. If the format `[condition]` is used, a space must appear immediately after the `[` and before the `]`.

condition is composed of one or more operators as shown in Table A.11. The `-a` operator has higher precedence than the `-o` operator. In any case, parentheses can be used to group subexpressions. Just remember that the parentheses are significant to the shell and so must be quoted. Operators and operands (including parentheses) must be delimited by one or more spaces so that `test` sees them as separate arguments.

`test` is most often used to test conditions in an `if`, `while`, or `until` command.

Examples

```
# see if perms is executable

if test -x /etc/perms
then
    ...
fi

# see if it's a directory or a normal file that's readable

if [ -d $file -o \( -f $file -a -r $file \) ]
then
    ...
fi
```

Table A.11 test Operators

Operator	Returns TRUE (zero exit status) if
File Operators	
-b <i>file</i>	<i>file</i> is a block special file
-c <i>file</i>	<i>file</i> is a character special file
-d <i>file</i>	<i>file</i> is a directory
-e <i>file</i>	<i>file</i> exists
-f <i>file</i>	<i>file</i> is an ordinary file
-g <i>file</i>	<i>file</i> has its set group id (SGID) bit set
-h <i>file</i>	<i>file</i> is a symbolic link
-k <i>file</i>	<i>file</i> has its sticky bit set
-L <i>file</i>	<i>file</i> is a symbolic link
-p <i>file</i>	<i>file</i> is a named pipe
-r <i>file</i>	<i>file</i> is readable by the process
-S <i>file</i>	<i>file</i> is a socket
-s <i>file</i>	<i>file</i> has nonzero length
-t <i>fd</i>	<i>fd</i> is an open file descriptor associated with a terminal (1 is default)
-u <i>file</i>	<i>file</i> has its set user id (SUID) bit set
-w <i>file</i>	<i>file</i> is writable by the process
-x <i>file</i>	<i>file</i> is executable

Operator	Returns TRUE (zero exit status) if
String Operators	
<i>string</i>	<i>string</i> is not null
-n <i>string</i>	<i>string</i> is not null (and <i>string</i> must be seen by test)
-z <i>string</i>	<i>string</i> is null (and <i>string</i> must be seen by test)
<i>string</i> ₁ = <i>string</i> ₂	<i>string</i> ₁ is identical to <i>string</i> ₂
<i>string</i> ₁ != <i>string</i> ₂	<i>string</i> ₁ is not identical to <i>string</i> ₂
Integer Comparison Operators	
<i>int</i> ₁ -eq <i>int</i> ₂	<i>int</i> ₁ is equal to <i>int</i> ₂
<i>int</i> ₁ -ge <i>int</i> ₂	<i>int</i> ₁ is greater than or equal to <i>int</i> ₂
<i>int</i> ₁ -gt <i>int</i> ₂	<i>int</i> ₁ is greater than <i>int</i> ₂
<i>int</i> ₁ -le <i>int</i> ₂	<i>int</i> ₁ is less than or equal to <i>int</i> ₂
<i>int</i> ₁ -lt <i>int</i> ₂	<i>int</i> ₁ is less than <i>int</i> ₂
<i>int</i> ₁ -ne <i>int</i> ₂	<i>int</i> ₁ is not equal to <i>int</i> ₂
Boolean Operators	
! <i>expr</i>	<i>expr</i> is FALSE; otherwise, returns TRUE
<i>expr</i> ₁ -a <i>expr</i> ₂	<i>expr</i> ₁ is TRUE, and <i>expr</i> ₂ is TRUE
<i>expr</i> ₁ -o <i>expr</i> ₂	<i>expr</i> ₁ is TRUE, or <i>expr</i> ₂ is TRUE

The times Command

General Format: times

Execution of this command causes the shell to write to standard output the total amount of time that has been used by the shell and by all its child processes. For each, two numbers are listed: first the accumulated user time and then the accumulated system time.

Note that times does not report the time used by built-in commands.

Example

```
$ times          Print time used by processes
1m5s 2m9s      1 min., 5 secs. user time, 2 mins., 9 secs. system time
8m22.23s 6m22.01s Time used by child processes
$
```

The trap Command

General Format: `trap commands signals`

This command tells the shell to execute *commands* whenever it receives one of the signals listed in *signals*. The listed signals can be specified by name or number.

`trap` with no arguments prints a list of the current trap assignments.

If the first argument is the null string, as in

```
trap "" signals
```

the signals in *signals* are ignored when received by the shell.

If the format

```
trap signals
```

is used, processing of each signal listed in *signals* is reset to the default action.

Examples

```
trap "echo hangup >> $ERRFILE; exit" HUP   Log message and exit on hangup
trap "rm $TMPFILE; exit" 1 2 15           remove $TMPFILE on signals 1, 2, or 15
trap "" 2                                  Ignore interrupts
trap 2                                     Reset default processing of interrupts
```

Table A.12 lists values that can be specified in the signal list.

Table A.12 **Signal Numbers and Names for trap**

Signal #	Signal Name	Generated for
0	EXIT	Exit from the shell
1	HUP	Hangup
2	INT	Interrupt (for example, Delete key, Ctrl+c)
3	QUIT	Quit
6	ABRT	Abort
9	KILL	Kill
14	ALRM	Alarm timeout
15	TERM	Software termination signal (sent by kill by default)

The shell scans *commands* when the `trap` command is encountered and again when one of the listed signals is received. This means, for example, that when the shell encounters the command

```
trap "echo $count lines processed >> $LOGFILE; exit" HUP INT TERM
```

it substitutes the value of `count` at that point, and *not when one of the signals is received*. You can get the value of `count` substituted when one of the signals is received if you instead enclose the commands in single quotes:

```
trap 'echo $count lines processed >> $LOGFILE; exit' HUP INT TERM
```

The `true` Command

General Format: `true`

This command returns a zero exit status.

The `type` Command

General Format: `type commands`

This command prints information about the indicated commands.

Examples

```
$ type troff echo
troff is /usr/bin/troff
echo is a shell builtin
$
```

The `umask` Command

General Format: `umask mask`

`umask` sets the default file creation mask to `mask`. Files that are subsequently created are ANDed with this mask to determine the mode of the file.

`umask` with no arguments prints the current mask. The `-s` option says to produce symbolic output.

Examples

```
$ umask                Print current mask
0002                   No write to others
$ umask 022           No write to group either
$
```

The `unalias` Command

General Format: `unalias names`

The aliases `names` are removed from the alias list. The `-a` option says to remove all aliases.

The unset Command

General Format: `unset names`

This causes the shell to erase definitions of the variables or functions listed in *names*. Read-only variables cannot be unset. The `-v` option to `unset` specifies that a variable name follows, whereas the `-f` option specifies a function name. If neither option is used, it is assumed that variable name(s) follow.

Example

```
unset dblist files           Remove definitions of variables dblist and files
```

The until Command

General Format:

```
until commandt
do
    command
    command
    ...
done
```

*command*_t is executed and its exit status tested. If it is nonzero, the commands enclosed between the `do` and `done` are executed. Then *command*_t is executed again and its status tested. If it is nonzero, the commands between the `do` and `done` are once again executed. Execution of *command*_t and subsequent execution of the commands between the `do` and `done` continues until *command*_t returns a zero exit status, at which point the loop is terminated. Execution then continues with the command that follows the `done`.

Because *command*_t gets evaluated immediately on entry into the loop, the commands between the `do` and `done` may never be executed if the test returns a zero exit status the first time.

Example

```
# sleep for 60 seconds until jack logs on
until who | grep jack > /dev/null
do
    sleep 60
done

echo jack has logged on
```

The preceding loop continues until the `grep` returns a zero exit status (that is, finds `jack` in `who`'s output). At that point, the loop is terminated, and the `echo` command that follows is executed.

The wait Command

General Format: `wait job`

This command causes the shell to suspend its execution until the process identified as *job* finishes executing. *Job* can be a process ID or a *job_id*. If *job* is not supplied, the shell waits for all child processes to finish executing. If more than one process id is listed, `wait` will wait for them all to complete.

`wait` is useful for waiting for processes to finish that have been sent to the background for execution.

Example

```
sort large_file > sorted_file &      sort in the background
. . .                                  Continue processing
wait                                   Now wait for sort to finish
plotdata sorted_file
```

The variable `#!` can be used to obtain the process ID of the last process sent to the background.

The while Command

General Format:

```
while commandt
do
    command
    command
    ...
done
```

command_t is executed and its exit status tested. If it is zero, the commands enclosed between the `do` and `done` are executed. Then *command_t* is executed again and its status tested. If it is zero, the commands between the `do` and `done` are once again executed. Execution of *command_t* and subsequent execution of the commands between the `do` and `done` continues until *command_t* returns a non-zero exit status, at which point the loop is terminated. Execution then continues with the command that follows the `done`.

Note that because *command_t* gets evaluated immediately on entry into the loop, the commands between the `do` and `done` may never be executed if the test returns a non-zero exit status the first time.

Example

```
# fill up the rest of the buffer with blank lines

while [ $lines -le $maxlines ]
do
    echo >> $BUFFER
    lines=$((lines + 1))
done
```

B

For More Information

Many sources of information on Unix, Linux and the Mac OS X command line are available, but we have selected titles and Web sites of particular value to shell programmers. All Web sites and URLs are valid as of the publication of this book, but as is often the case on the Internet, some may not be available by the time you read this.

There is one reference that you cannot do without. This is the built-in documentation for your particular system, which offers detailed descriptions of the syntax and various options for each command.

Online Documentation

If a printed version of your system's documentation isn't available, you can use the `man` command to get information (referred to as the "man pages") about any specific Unix command. The format is

```
man command
```

Not sure of the command name? `man -k` can help you identify the specific Linux or Unix command you seek, as in this example from Ubuntu Linux:

```
$ man -k dvd
brasero (1)          - Simple and easy to use CD/DVD burning application for ...
btcflash (8)        - firmware flash utility for BTC DRW1008 DVD+/-RW recorder.
dvd+rw-booktype (1) - format DVD+/-RW/-RAM disk with a logical format
dvd+rw-format (1)  - format DVD+/-RW/-RAM disk
dvd+rw-mediainfo (1) - display information about dvd drive and disk
dvd-ram-control (1) - checks features of DVD-RAM discs
growisofs (1)      - combined genisoimage frontend/DVD recording program.
rpl8 (8)           - Firmware loader for DVD drives
$
```

Some systems have an interactive documentation command called `info`. To invoke it, simply type `info` and after it starts up, type `h` for a tutorial.

Documentation on the Web

The best place on the Web for information on the POSIX standard is at www.unix.org. This site is maintained by The Open Group, an international consortium that worked with the IEEE to create the current POSIX specification. The complete specification is available on its Web site. You must register first to read it, but registration is free. The URL for accessing the documentation is www.unix.org/online.html.

The Free Software Foundation maintains online documentation for a variety of Linux and Unix utilities, notably including Bash and the C compiler, at www.fsf.org/manual.

David Korn, the developer of the Korn shell, maintains www.kornshell.com. It contains documentation, downloads, information on books on the Korn shell, and links to information on other shells.

If you only have access to Microsoft Windows systems but still want to try your hand at shell programming, or you just want to get a taste of Linux, we encourage you to install the Cygwin package from www.cygwin.com. The base system includes Bash and lots of other command line utilities, offering a system remarkably Linux and Unix like. Best of all, the entire Cygwin package is free to download and use.

Books

O'Reilly & Associates

A good source of books on Linux and Unix-related topics is O'Reilly and Associates (www.ora.com). Their books cover a wide variety of subjects and are available from their Web site, from booksellers online, and in book stores. Their Web site also has many useful articles on Unix and Linux.

Two good references on Unix and Linux, respectively:

Unix in a Nutshell, 4th Edition, A. Robbins, O'Reilly & Associates, 2005.

Linux in a Nutshell, 6th Edition, E. Siever, S. Figgins, R. Love and A. Robbins, O'Reilly & Associates, 2009.

Two good books on Perl programming, from beginner to advanced:

Learning Perl, 6th Edition, R. L. Schwartz, B. Foy and T. Phoenix, O'Reilly & Associates, 2011.

Perl in a Nutshell, 2nd Edition, S. Spainhour, E. Siever, and N. Patwardhan, O'Reilly & Associates, 2002

A good book covering both the POSIX standard versions of `awk` and `sed` as well as the GNU versions:

Sed & Awk, 2nd Edition, D. Dougherty and A. Robbins, O'Reilly & Associates, 1997 (ISBN 978-1-56592-225-9).

Want to learn more about the Unix command line from a Mac user's perspective? We recommend:

Learning Unix for OS X, D. Taylor, O'Reilly & Associates

Pearson

Learn the essentials of Unix shell programming from the ground up:

Sams Teach Yourself Shell Programming in 24 Hours, 2nd Edition, S. Veeraraghaven, Sams Publishing, 2002.

A good book for learning Unix and programming in C and Perl on a Unix system:

Sams Teach Yourself Unix in 24 Hours, 5th Edition, D. Taylor, Sams Publishing, 2016.

This title offers a broad range of topics related to FreeBSD, a robust and free UNIX that many demanding enterprises use in place of Linux. It is detailed in its approach and offers information not found anywhere else:

FreeBSD Unleashed, 2nd Edition, M. Urban and B. Tiemann, Sams Publishing, 2003.

Learn FreeBSD from the ground up. This book is the only beginning level tutorial that offers all the ins and outs of the FreeBSD operating system:

Sams Teach Yourself FreeBSD in 24 Hours, Michael Urban and Brian Tiemann, 2002.

The Unix C Shell Field Guide, G. Anderson and P. Anderson, Prentice Hall, 1986.

An in-depth reference to the C shell.

The AWK Programming Language, A. V. Aho, B. W. Kernighan, and P. J. Weinberger, Addison-Wesley, 1988.

A complete description of the `awk` language authored by its creators.

The Unix Programming Environment, B. W. Kernighan and R. Pike, Prentice Hall, 1984.

An advanced Unix programming book.

Advanced Linux Programming, M. Mitchell, J. Oldham, and A. Samuel, New Riders Publishing, 2001.

An advanced Linux programming book.

This page intentionally left blank

Index

Symbols

& (ampersand)

- && construct, 161–162
- background execution of loops, 177
- command sequences and, 322

*** (asterisk)**

- with case statement, 155
- filename substitution, 24–25, 47, 331
- pattern matching, 57–59, 63, 242, 336

` (back quote), 114–115

\ (backslash)

- escaping characters with, 111–112
- inside double quotes, 112–114
- line continuation, 112
- overview, 322

[] (brackets), 139–140

^ (caret), 53, 63

: (colon)

- : (null) command, 160–161, 334
- in directories, 218

((.)) construct, 311

(.) construct, 47, 231–234, 332

\.\) construct, 61–63, 64

\{.\} construct, 59–61, 64

#! construct, 289–290

|| construct, 161–162

\$(.) construct, 115–118

[!] construct, 242

- [.] construct, 55–57, 242, 336
- { .; } construct, 231–234, 332
- >& construct, 261–262
- >&- construct, 262
- <&- construct, 262
- \$ (dollar sign)
 - command prompt, 43
 - parameter substitution
 - $\${parameter}$, 239–240
 - $\${parameter:+value}$, 242
 - $\${parameter:=value}$, 241
 - $\${parameter:-value}$, 240
 - $\${parameter:?value}$, 241–242
 - pattern matching, 53–54, 63
 - variable substitution, 98–100
- " (double quotes)
 - backslash (\) in, 112–114
 - grouping character sequences with, 109–111
- (hyphen)
 - command options, 8
 - job control, 315
 - printf format specification modifier, 206
- < (left arrow), 48–49, 331–332
- ! (logical negation) operator, 143, 322
- \$(()) operator, 103
- % (percent sign)
 - %% format specification character, 203
 - %b format specification character, 203
 - %c format specification character, 203
 - %d format specification character, 203
 - %o format specification character, 203
 - %s format specification character, 203
 - %u format specification character, 203
 - %X format specification character, 203
 - %x format specification character, 203
 - job control, 315
 - pattern matching, 242–243
 - with printf command, 202
- . (period)
 - dot (.) command, 227–230, 334–335
 - pattern matching, 51–53, 63
- | (pipe) symbol
 - || construct, 161–162
 - case command, 159–160
 - loops, 178–179
 - pipeline process, 33–34, 49, 321, 322
- + (plus sign)
 - job control, 315
 - pattern matching, 63
 - printf format specification modifier, 206
- # (pound sign)
 - comments, 96
 - pattern matching, 243
 - printf format specification modifier, 206
- ? (question mark)
 - filename substitution, 25–27, 47, 331
 - pattern matching, 242, 336
- >> (redirection append) characters, 31–32, 48–49
- << (redirection append) characters
 - shell archive creation, 264–267
 - syntax, 262–264
- > (right arrow), 30–32, 48–49, 331–332
- ;(semicolon), 36, 179–180, 321
- ' (single quotes), 105–108
- ~ (tilde) substitution, 318–319, 329
- _ (underscore), 322
- \$? \$! variable, 323
- #! variable, 257–258, 323

\$- variable, 323
 \$# variable, 122–123, 323
 \$\$ variable, 198–199, 323
 \$* variable, 123–124, 166, 323
 \$@ variable, 166–167, 323
 \$0 variable, 245, 323
 \${n} variable, 128
 \${variable} construct, 98–100, 102–103

A

-a (logical AND) operator, 143–144
access modes, 16–17
accessing command history.
 See **command history**
add program, 125–127, 277
addi program, 200
alias command, 307–309, 335
aliases
 defining, 307–309
 removing, 309
allexport shell mode, 350
alternative format for test command,
 139–140
ampersand (&)
 && construct, 161–162
 background execution of loops, 177
 command sequences and, 322
archives, creating, 264–267
args program, 122–123
arguments
 definition of, 321
 passing
 \$# variable, 122–123
 \$* variable, 123–124
 \${n} special variable, 128
 phonebook file example,
 124–128

 positional parameters, 121–122
 shift command, 128–129
 processing, 343–344
arithmetic
 arithmetic expansion, 103–104
 arithmetic expressions, 330
 expr command, 119–120
 integer arithmetic
 integer types, 304–305
 numbers in different bases, 305–306
 overview, 303–304
 line sorting, 86
arrays, 309–314
ASCII characters, octal values of, 75
asterisk (*)
 with case statement, 155
 filename substitution, 24–25, 47, 331
 pattern matching, 57–59, 63, 242, 336
asynchronous jobs, 257
automatically loaded functions, 303
awk command, 91

B

%b format specification character, 203
back quote (`), 114–115
background execution
 commands, 36–37
 jobs, 316–317
 loops, 177
backslash (\)
 escaping characters with,
 111–112
 inside double quotes, 112–114
 line continuation, 112
 overview, 322
bases, numbers in different bases,
 305–306

Bash shell. *See also nonstandard shell features*

- compatibility summary, 319–320
- history of, 289
- Web documentation, 360

beginning of line, matching, 53**Bell Laboratories, 1****bg command, 316–317, 335****blocks of storage, 16****body of loops, 164****books, recommended, 360–361****Bourne, Stephen, 1****brackets ([]), 139–140****break command, 174–176, 336****breaking out of loops, 174–176**

C

C compiler, 360**%c format specification character, 203****caret (^), 53, 63****case command**

- debugging, 157–159
- overview, 336–337
- pattern-matching characters, 155–156
- pipe symbol (|), 159–160
- syntax, 153–154

cat command, 7**cd command, 12–15, 317–318, 337****cdh function, 312–314****CDPATH variable, 323, 337****cdtest program, 225****change program, 281–283****changing**

- directories, 12–15, 337
- group id (GID), 347–348
- phonebook file entries, 281–283

character sets, matching, 55–57**characters.** *See also text*

ASCII characters, octal values of, 75

character sequences

- double quotes ("), 109–111
- single quotes ('), 105–108

cutting, 64–68**deleting from input stream, 77–78****echoing, 6****escaping, 111–112****in filenames**

- allowed characters, 6
- special characters, 28

format specification characters (printf), 202–205**pattern matching**

- any character, 51–53
- beginning of line, 53
- character sets, 55–57
- end of line, 53–54
- filename substitution, 25–27
- matched characters, saving, 61–63
- overview, 155–156
- parameter substitution, 242–244
- precise number of characters, 59–61
- zero or more characters, 57–59

quote characters

- backslash (\), 111–114
- double quotes ("), 109–111
- single quotes ('), 105–108

translating from standard input, 74–77**child processes, 257****clauses, else, 145–147, 345–346****closing standard output, 262****colon (:)**

- : (null) command, 334
- in directories, 218

for command

- \$* variable, 166
- \$@ variable, 166–167
- overview, 163–166, 342–343
- without in element, 167–168

command cycle, 43

command files, 93–96

command history

- accessing
 - emacs line edit mode, 294–296
 - fc command, 301, 326
 - history command, 294–296, 300–301
 - quoting, 329
 - r command, 301–303
 - vi line edit mode, 294–296, 326–329

- controlling size of, 292
- editing commands in, 341

command line. See commands

Command not found error, 94

command prompt, 43

command substitution

- \$(.) construct, 115–118
- back quote (`), 114–115
- definition of, 112
- expr command, 119–120

command-line editing

- command history
 - accessing with vi, 294–296
 - controlling size of, 292
- emacs line edit mode
 - command history, accessing, 296–298
 - overview, 296–298
- overview, 291

vi line edit mode

- command history, accessing, 294–296
- overview, 292–294

commands

- (.) construct, 332
- {.;} construct, 332
- alias, 307–309, 335
- arguments, passing
 - \$# variable, 122–123
 - \$* variable, 123–124
 - \${n} special variable, 128
 - overview, 343–344
 - phonebook file example, 124–128
 - positional parameters, 121–122
 - shift command, 128–129

awk, 91

bg, 316–317, 335

break, 174–176, 336

case

- debugging, 157–159
- overview, 336–337
- pattern-matching characters, 155–156
- pipe symbol (|), 159–160
- syntax, 153–154

cat, 7

cd, 12–15, 317–318, 337

command cycle, 43

command history

- accessing, 326–329
- editing commands in, 341

command re-entry, 326

command summary, 37–38

continue, 176–177, 338

cp, 8, 18–19

- cut
 - d option, 66–68
 - f option, 66–68
 - overview, 64–66
- date, 5, 95–96, 237
- dot (.), 334–335
- echo
 - escape characters, 187–188
 - overview, 6, 338–339
- emacs line edit commands, 299–300
- entering, 43–44
- eval, 255–257, 339
- exec, 230–231, 262, 339
- exit, 147–148, 340
- export, 340–341
- expr, 119–120
- false, 341
- fc, 301, 326–Z01.2304, 341
- fg, 316–317, 342
- for
 - \$* variable, 166
 - \$@ variable, 166–167
 - overview, 163–166, 342–343
 - without in element, 167–168
- format of, 321–322
- getopts, 180–184, 343–344
- grep
 - l option, 82–83
 - n option, 83
 - overview, 78–81
 - regular expressions, 81–82
 - v option, 82
- grouping, 231–234
- hash, 344
- history, 294–296, 300–301
- if. *See* if statement
- info, 359
- jobs, 315, 347
- kill, 315, 347
- ln, 20–23
- ls, 7, 15–17
- man, 359
- mkdir, 17–18
- multiple commands on same line, 36
- mv, 8–9, 19
- newgrp, 347–348
- null (:), 160–161, 334
- od, 251
- options, 8
- paste
 - d option, 69–70
 - overview, 68–69
 - s option, 70
- perl, 91
- printf
 - example, 206–207
 - format specification characters, 202–205
 - format specification modifiers, 205–206
 - syntax, 202
- printing information about, 356
- ps, 37
- pwd, 12, 95–96, 348
- quoting, 329
- r, 301–303
- read
 - exit status, 199–202
 - menu-driven phone program (rolo), 193–199
 - mycp program, 185–193
 - overview, 348–349
 - syntax, 185
- readonly, 349

- readonly, 254
- return, 271, 349
- returning information about, 271
- rm, 9
- rmdir, 22–23
- scanning twice before executing, 255–257
- sed
 - d command, 73
 - examples, 73
 - n option, 72
 - syntax, 70–72
- sending to background, 36–37
- set
 - option, 248–250
 - IFS variable, 251–254
 - monitor option, 331–332
 - with no arguments, 247
 - overview, 239, 321, 350–351
 - positional parameters, reassigning, 247–248
 - x option, 246
- shift, 128–129, 352
- skipping in loops, 176–177
- sort
 - k2n option, 87
 - n option, 86
 - o option, 85
 - other options, 88
 - overview, 84
 - r option, 85
 - t option, 87–88
 - u option, 84
- substitution
 - \$(.) construct, 115–118
 - back quote (`), 114–115
 - definition of, 112
 - expr command, 119–120
 - test, 135, 352–354
 - tilde substitution, 318–319, 329
 - times, 354, 355–356
 - tr
 - d option, 77–78
 - examples, 78
 - octal values of ASCII characters, 75
 - overview, 74–76
 - s option, 76–77
 - trap
 - execution with no arguments, 259–260
 - ignored signals, 260
 - overview, 258–259
 - signal numbers, 258
 - trap reset, 261
 - true, 356
 - type, 271
 - typing on one line, 179–180
 - umask, 356
 - unalias, 309, 356
 - uniq
 - c option, 90
 - d option, 89–90
 - overview, 88–89
 - unset, 254, 271, 357
 - until, 170–174, 357
 - vi line edit commands, 296, 326–329
 - wait, 257, 358
 - wc, 7, 95–96
 - while, 168–170
 - who, 5–6

comments, 96, 322

compatibility of shells, 319–320

conditional statements. *See also* loops

- && construct, 161–162
- || construct, 161–162
- if
 - case command, 153–160
 - elif construct, 148–151
 - else construct, 145–147
 - exit command, 147–148
 - exit status, 131–135
 - null command (:), 160–161
 - pipe symbol (|), 159–160
 - syntax, 131
 - testing conditions in, 131–144
- nesting, 148–149
- testing conditions in
 - alternative format for test, 139–140
 - file operators, 142–143
 - integer operators, 140–142
 - logical AND operator (-a), 143–144
 - logical negation operator (!), 143
 - logical OR operator (-o), 144
 - overview, 135
 - string operators, 135–139

contents of files, displaying, 7**continuation of lines, 112****continue command, 176–177, 338****Coordinated Universal Time, 237****copying files**

- to another directory, 18–19
- mycp program
 - echo escape characters, 187–188
 - final code listing, 190–193
 - initial code listing, 185–187
 - revised code listing, 188–190

into new file, 8

counting words in files, 7**cp command, 8, 18–19****creating**

- aliases, 307–309
- directories, 17–18
- functions, 268
- pointers to variables, 257
- shell archives, 264–267

ctype program, 155–156, 158–159**current directory, 225–226****cut command**

- d option, 66–68
- f option, 66–68
- overview, 64–66

Cygwin, 360

D

d command, 73**-d file operator, 142–143****%d format specification character, 203****dangling symbolic links, 23****data.** *See also* I/O (input/output) redirection

extracting

- cut command syntax, 64–66
- delimiter characters, 66–68
- fields, 66–68

printing

- command information, 356
- date/time, 5, 95–96
- formatted output, 202–207
- list of active jobs, 347
- to working directory, 348

reading

- exit status, 199–202
- menu-driven phone program (rolo)
 - example, 193–199
- mycp program, 185–193
- read command syntax, 185

data formatting (rolo program), 273–274

date command, 5, 95–96, 237

date/time, printing, 5, 95–96

db program, 227–229

debugging with -x, 157–159

defining. See creating

definitions (function)

creating, 268

removing, 271

deleting

aliases, 309

characters from input stream, 77–78

directories, 22–23

duplicate lines

sort command, 84

uniq command, 88–89

files, 9

function definitions, 271

lines, 73

phonebook file entries, 127–128,
280–281

delimiter characters

cut command, 66–68

paste command, 69–70

sort command, 87–88

development of Unix, 1

/dev/tty, 178

directories

changing, 12–15, 337

copying files to, 18–19

creating, 17–18

current directory, 225–226

directory files, 6

home, 10–12, 217

moving files between, 19

pathnames, 10–12

removing, 22–23

structure of, 9–10

working directory

definition of, 10

displaying, 12

printing to, 348

disabling trace mode, 246

display program, 278–279

displaying

error messages, 245

file contents, 7

phonebook file entries, 278–279

variable values, 98–100

working directory, 12

documentation

books, 360–361

comments, 96

here documents

shell archive creation,
264–267

syntax, 262–264

online documentation, 359

Web documentation, 360

dollar sign (\$)

command prompt, 43

parameter substitution

$\${parameter}$, 239–240

$\${parameter:+value}$, 242

$\${parameter:=value}$, 241

$\${parameter:-value}$, 240

$\${parameter:?value}$, 241–242

pattern matching, 53–54, 63

variable substitution, 98–100

dot (.) command, 227–230

double quotes (")

backslash (\) in, 112–114

grouping character sequences with,
109–111

duplicate entries, finding, 89–90

duplicate lines, eliminating

- sort command, 84
- uniq command, 88–89

E

-e file operator, 142–143**echo command**

- escape characters, 187–188
- overview, 6, 338–339

editing

- command-line editing
 - command history, 292
 - emacs line edit mode, 296–300
 - overview, 291
 - vi line edit mode, 292–296
- phonebook file entries, 281–283

editors

- stream editor (sed)
 - command syntax, 70–72
 - d command, 73
 - examples, 73
 - n option, 72
- vi line edit mode, 326–329

elements of arrays, retrieving, 309–310**elif construct, 148–151****else clause, 145–147, 345–346****emacs line edit mode**

- command history, accessing, 296–298
- overview, 296–298

enabling trace mode, 246**end of line, matching, 53–54****end-of-line character, 45****entering**

- commands, 43–44
- passwords at login, 41

entries (phonebook file)

- adding, 125–127, 277
- displaying, 278–279
- editing, 281–283
- listing, 283–284
- looking up, 124–125, 278
- removing, 127–128, 280–281

ENV file, 290–291**ENV variable, 290–291, 323****environment**

- current directory, 225–226
- exported variables, 211–216
- HOME variable, 217
- local variables, 209–210
- PATH variable, 217–224
- .profile file, 235–236
- PS1 variable, 216
- PS2 variable, 216
- subshells
 - (.) construct, 231–234
 - { ; } construct, 231–234
 - dot (.) command, 227–230
 - exec command, 227–230
 - overview, 210–211, 227
 - passing variables to, 234–235
 - TERM variable, 236–237
 - TZ variable, 236–237

environment control, 49**-eq operator, 140–142****errexit shell mode, 350****errors**

- Command not found, 94
- error messages, displaying, 245
- standard error, 35

escape characters (echo command), 187–188, 338**escaping characters, 111–112**

- `/etc/passwd`, 41
- `/etc/profile`, 235–236
- `/etc/shadow`, 41
- `eval` command, 255–257, 339
- exclamation mark (!), 322
- `exec` command, 230–231, 262, 339
- executable files, 94
- execution
 - background execution of loops, 177
 - command execution
 - command files, 93–96
 - scanning command line twice before executing, 255–257
 - in current shell, 227–230
 - function execution, 268–269
 - program execution, 45–47
 - subshell execution, 332
- `exit` command, 147–148, 340
- `EXIT` signal, 258
- exit status
 - `$?` variable, 132–135
 - definition of, 321
 - non-zero values, 131
 - overview, 131–132
 - `read` command, 199–202
 - zero values, 131
- `export` command, 340–341
- exported variables, 211–216, 332, 340–341
- `expr` command, 119–120
- expressions
 - arithmetic expressions, 330
 - regular expressions
 - [.] construct, 55–57
 - \(.\) construct, 61–63
 - \{.\} construct, 59–61
 - asterisk (*), 57–59

- caret (^), 53
- dollar sign (\$), 53–54
- `grep` command, 81–82
- overview, 51
- period (.), 51–53
- summary table, 61–63

extracting data

- cut command
 - delimiter characters, 66–68
 - fields, 66–68
 - overview, 64–66

F

- `-f` file operator, 142–143
- `false` command, 341
- `fc` command, 301, 326–Z01.2304, 341
- `FCEDIT` variable, 323
- `fg` command, 316–317, 342
- fields
 - cutting, 66–68
 - skipping during sort, 87
- file descriptors, 261
- file operators, 142–143
- filename substitution
 - asterisk (*), 24–25
 - overview, 47, 331
 - POSIX shell, 331
 - question mark (?), 25–27
 - variables, 101–103
- files
 - command files, 93–96
 - copying
 - to another directory, 18–19
 - `mycp` program, 185–193
 - into new file, 8
 - counting words in, 7
 - directory files, 6

- displaying contents of, 7
 - duplicate entries, finding, 89–90
 - ENV, 290–291
 - executable files, 94
 - executing in current shell, 227–230
 - file descriptors, 261
 - file operators, 142–143
 - filename substitution
 - * (asterisk), 24–25
 - ? (question mark), 25–27
 - asterisk (*), 24–25
 - overview, 47, 331
 - POSIX shell, 331
 - question mark (?), 25–27
 - variables, 101–103
 - filenames
 - allowed characters, 6
 - changing, 8–9
 - spaces in, 27
 - special characters, 28
 - linking, 20–23
 - listing, 7, 15–17
 - moving between directories, 19
 - ordinary files, 6
 - overview, 6–7
 - phonebook
 - adding entries to, 125–127, 277
 - displaying entries from, 278–279
 - editing entries in, 281–283
 - listing entries in, 283–284
 - looking up entries in, 124–125, 278
 - removing entries from, 127–128, 280–281
 - .profile, 235–236
 - removing, 9
 - renaming, 8–9
 - rolosubs file, 264–266
 - searching with grep
 - l option, 82–83
 - n option, 83
 - overview, 78–81
 - regular expressions, 81–82
 - v option, 82
 - sorting lines into, 85
 - special files, 6
 - temporary files, 198–199
- filters, 35**
- finding.** See **pattern matching**
- foreground jobs**
- bringing jobs to, 342
 - stopping, 316–317
- format specification (printf)**
- characters, 202–205
 - modifiers, 205–206
- formatted output, printing**
- example, 206–207
 - format specification characters, 202–205
 - format specification modifiers, 205–206
 - printf command syntax, 202
- Fox, Brian, 289**
- Free Software Foundation, 289, 360**
- fsf.org website, 360**
- functions**
- automatically loaded functions, 303
 - cdh, 312–314
 - definitions
 - creating, 268–271
 - removing, 271
 - execution, 268–269
 - local variables, 303
 - overview, 333
 - terminating, 271

G

- ge operator, 140–142**
- getopts command, 180–184, 343–344**
- getty program. See shells**
- GID (group id), changing, 347–348**
- greetings program, 149–151, 159–160**
- grep command**
 - l option, 82–83
 - n option, 83
 - overview, 78–81
 - regular expressions, 81–82
 - v option, 82
- group id (GID), changing, 347–348**
- grouping commands, 231–234**
- groups, 16–17**
- gt operator, 140–142**

H

- handing signals with trap command**
 - execution with no arguments, 259–260
 - ignored signals, 260
 - overview, 258–259
 - signal numbers, 258
 - trap reset, 261
- hash command, 344**
- hash sign (#)**
 - comments, 96
 - pattern matching, 243
 - printf format specification modifier, 206
- here documents**
 - shell archive creation, 264–267
 - syntax, 262–264
- HISTFILE variable, 323**
- history command, 294–296, 300–301.**
See also **command history**

- history of Unix, 1**
- HISTSIZE variable, 326**
- home directory, 10–12, 217**
- HOME variable, 217, 323**
- HUP signal, 258**
- hyphen (-)**
 - command options, 8
 - job control, 315
 - printf format specification modifier, 206

I

- if statement**
 - case command
 - debugging, 157–159
 - pattern-matching characters, 155–156
 - pipe symbol (|), 159–160
 - syntax, 153–154
 - elif construct, 148–151
 - else construct, 145–147
 - exit command, 147–148
 - exit status
 - \$? variable, 132–135
 - non-zero values, 131
 - overview, 131–132
 - zero values, 131
 - nesting, 148–149
 - null command (:), 160–161
 - overview, 344–346
 - syntax, 131
 - testing conditions in
 - alternative format for test, 139–140
 - file operators, 142–143
 - integer operators, 140–142
 - logical AND operator (-a), 143–144
 - logical negation operator (!), 143

- logical OR operator (-o), 144
- overview, 135
- parentheses, 144
- string operators, 135–139
- test command syntax, 135

IFS variable, 251–254, 323**ignoreeof shell mode, 351****ignoring signals, 260****infinite loops, breaking out of, 174–176****info command, 359****init program, 40–43****input redirection**

- < (left arrow), 331
- exec command, 230–231, 262
- in-line input redirection
 - shell archive creation, 264–267
 - syntax, 262–264
- POSIX shell, 331
- standard I/O (input/output), 28–30

INT signal, 258**integer arithmetic**

- expr command, 119–120
- integer types, 304–305
- numbers in different bases, 305–306
- overview, 303–304

integer operators, 140–142**integer types, 304–305****interactive shell features**

- aliases
 - defining, 307–309
 - removing, 309
- arrays, 309–314
- cd command, 317–318
- command history, accessing
 - emacs line edit mode, 296–298
 - fc command, 301
 - history command, 300–301

- r command, 301–303
- vi line edit mode, 294–296

command-line editing

- command history, 292
- emacs line edit mode, 296–300
- overview, 291
- vi line edit mode, 292–296

ENV file, 290–291**functions**

- automatically loaded functions, 303
- local variables, 303

integer arithmetic

- integer types, 304–305
- numbers in different bases, 305–306
- overview, 303–304

job control, 315–317**order of search, 319****shell, specifying, 290****tilde substitution, 318–319****internal field separators, 251–254****interpreted programming language, 50****I/O (input/output) redirection**

- <&- construct, 262
- >&- construct, 262
- input redirection
 - < (left arrow), 331
 - exec command, 230–231, 262
 - in-line input redirection, 262–267
 - overview, 331
 - POSIX shell, 331
 - shell archive creation, 264–267
 - standard I/O (input/output), 28–30
- loops, 177–178
- output redirection
 - exec command, 230–231, 262
 - overview, 30–32
 - standard output, closing, 262

overview, 48–49, 331–332
 in programs, 94
 standard error, writing to,
 261–262
 standard I/O (input/output), 28–30
ison program, 122

J

jobs

asynchronous jobs, 257
 bringing to foreground, 342
 job control, 315–317
 job numbers, 37
 killing, 347
 printing list of, 347
 referencing, 333–334
 sending to background, 316–317
 stopped jobs, 316–317
 stopping, 334
 waiting for, 358
 waiting for completion
 \$! variable, 257–258
 wait command, 257
jobs command, 315, 347

K

kernel, 1, 39
keyword parameters. See **variables (shell)**
kill command, 315, 347
killing jobs, 347
Korn, David, 289, 360
Korn shell. See *also* **nonstandard shell features**
 compatibility summary, 319–320
 history of, 289
 Web documentation, 360
kornshell.com website, 360

L

-L file operator, 142–143

-le operator, 140–142

**left-shifting positional parameters,
 128–129**

line edit modes

emacs

command history, accessing,
 296–298

overview, 296–298

overview, 291

vi

command history, accessing,
 294–296

overview, 292–294

in-line input redirection

shell archive creation, 264–267

syntax, 262–264

LINENO variable, 324

lines

cutting, 64–66

deleting, 73

duplicate lines, eliminating

sort command, 84

uniq command, 88–89

line continuation, 112

pastings

from different files, 68–69

output delimiters, 69–70

from same file, 70

pattern matching

beginning of line, 53

end of line, 53–54

sorting

arithmetically, 86

delimiter characters, 87–88

duplicate lines, eliminating, 84

- to output file, 85
- overview, 84
- reverse order, 85
- skipped fields, 87

linking files, 20–23**Linux resources**

- books, 360–361
- online documentation, 359
- overview, 359
- Web documentation, 360

listall program, 283–284**listing**

- files, 7, 15–17
- phonebook file entries, 283–284
- variables, 247

In command, 20–23**local variables, 209–210, 303****logical AND operator (-a), 143–144****logical negation operator (!), 143, 322****logical OR operator (-o), 144****login cycle, 44****login shell, 40–43****looking up phonebook entries, 124–125, 278****for loops, 342–343****loops**

- body of, 164
- breaking out of, 174–176
- executing in background, 177
- for
 - \$* variable, 166
 - @\$ variable, 166–167
 - overview, 163–166, 342–343
 - without in element, 167–168
- getopts command, 180–184
- I/O redirection, 177–178
- pipng data into and out of, 178–179

- skipping remaining commands in, 176–177

terminating, 336

- typing on one line, 179–180

until, 170–174

- while, 168–170, 358

ls command, 7, 15–17**-lt operator, 140–142****lu program, 124–125, 278**

M

MAIL variable, 324**MAILCHECK variable, 324****MAILPATH variable, 324****man command, 359****matched characters, saving, 61–63****matching patterns**

- any character, 51–53
- beginning of line, 53
- case command, 155–156, 336–337
- character sets, 55–57
- duplicate entries, 89–90
- end of line, 53–54
- filename substitution, 25–27
- grep command
 - l option, 82–83
 - n option, 83
 - overview, 78–81
 - regular expressions, 81–82
 - v option, 82
- matched characters, saving, 61–63
- overview, 51
- parameter substitution, 242–244
- precise number of subpatterns, 59–61
- summary of regular expression
 - characters, 63–64
 - zero or more characters, 57–59

mathematical equation solver (expr), 119–120

menu-driven phone program (rolo)

- \$\$ variable, 198–199
- add program, 277
- change program, 281–283
- data formatting, 273–274
- display program, 278–279
- final code listing, 274–277
- initial code listing, 193–194
- listall program, 283–284
- lu program, 278
- rem program, 280–281
- revised code listing, 196–198
- sample output, 284–287
- sample runs, 195–196
- temporary files, 198–199

messages (error), displaying, 245

minus sign (-). See hyphen (-)

mkdir command, 17–18

monitor option (set command), 331–332

monitor shell mode, 351

moving files between directories, 19

multiple commands on same line, 36

mv command, 8–9, 19

mybasename program, 244

mycp program

- echo escape characters, 187–188
- final code listing, 190–193
- initial code listing, 185–187
- revised code listing, 188–190

N

-n string operator, 137, 138

names

- filename substitution
 - asterisk (*), 24–25

overview, 27, 47, 331

POSIX shell, 331

question mark (?), 25–27

variables, 101–103

filenames

allowed characters, 6

changing, 8–9

spaces in, 27

special characters, 28

pathnames, 10–12

-ne operator, 140–142

nesting if statements, 148–149

newgrp command, 347–348

newline character, 45

noclobber shell mode, 351

noexec shell mode, 351

noglob shell mode, 351

nolog shell mode, 351

nonstandard shell features

aliases

defining, 307–309

removing, 309

arrays, 309–314

cd command, 317–318

command history, accessing

emacs line edit mode, 296–298

fc command, 301

history command, 300–301

r command, 301–303

vi line edit mode, 294–296

command-line editing

command history, 292

emacs line edit mode, 296–300

overview, 291

vi line edit mode, 292–296

ENV file, 290–291

functions

- automatically loaded functions, 303
 - local variables, 303
- integer arithmetic
 - integer types, 304–305
 - numbers in different bases, 305–306
 - overview, 303–304
- job control, 315–317
- numbers, 304–305
- order of search, 319
- shell, specifying, 290
- tilde substitution, 318–319
- non-zero exit status, 131**
- nounset shell mode, 351**
- null command (:), 160–161**
- null values, 100–101**
- number program, 154–155, 201–202**
- number 2 program, 253**
- numbers**
 - in different bases, 305–306
 - job numbers, 37
 - signal numbers, 258, 355

O

- %o format specification character, 203**
- o (logical OR) operator, 144**
- octal dump command, 251**
- octal values of ASCII characters, 75**
- od command, 251**
- online documentation, 359**
- The Open Group, 360**
- AND operator, 143–144**
- OR operator, 144**
- operators**
 - $\$(())$, 103
 - arithmetic operators, 330
 - file operators, 142–143

- integer operators, 140–142
- logical AND operator (-a), 143–144
- logical negation operator (!), 143
- logical OR operator (-o), 144
- string operators, 135–139
- test operators, 353–354
- options (command), 8**
- ordinary files, 6**
- O'Reilly & Associates, 360–361**
- output**
 - output redirection
 - > (right arrow), 30–32
 - exec command, 230–231, 262
 - POSIX shell, 331–332
 - standard output, closing, 262
 - standard I/O (input/output), 28–30
- output delimiters**
 - paste command, 69–70
 - sort command, 88

P

- packages, Cygwin, 360**
- parameters. See also variables (shell)**
 - overview, 239
- parameter substitution
 - $\${parameter}$, 239–240
 - $\${parameter:+value}$, 242
 - $\${parameter:=value}$, 241
 - $\${parameter:-value}$, 240
 - $\${parameter:?value}$, 241–242
 - overview, 324–325
 - pattern matching, 242–244
- positional parameters
 - definition of, 239
 - left-shifting, 128–129
 - overview, 322

- reassigning values to, 239, 247–248
- setting, 350
- shifting left, 352
- substitution, 121–122
- special parameters, 323–324
- parent processes, 257**
- parentheses in test command, 144**
- parsing phase, 44**
- passing**
 - arguments
 - \$# variable, 122–123
 - \$* variable, 123–124
 - \${n} special variable, 128
 - phonebook file example, 124–128
 - positional parameters, 121–122
 - shift command, 128–129
 - variables to subshells, 234–235
- passwords, entering at login, 40**
- paste command**
 - d option, 69–70
 - overview, 68–69
 - s option, 70
- pasting lines**
 - from different files, 68–69
 - output delimiters, 69–70
 - from same file, 70
- PATH variable, 217–224, 324**
- pathnames, 10–12**
- pattern matching**
 - any character, 51–53
 - beginning of line, 53
 - case command, 155–156, 336–337
 - character sets, 55–57
 - duplicate entries, 89–90
 - end of line, 53–54
 - filename substitution, 25–27
 - grep command
 - l option, 82–83
 - n option, 83
 - overview, 78–81
 - regular expressions, 81–82
 - v option, 82
 - matched characters, saving, 61–63
 - overview, 51
 - parameter substitution, 242–244
 - precise number of subpatterns, 59–61
 - summary of regular expression characters, 63–64
 - zero or more characters, 57–59
- Pearson books, 361**
- percent sign (%)**
 - job control, 315
 - pattern matching, 242–243
 - with printf command, 202
- period (.)**
 - dot (.) command, 227–230, 334–335
 - pattern matching, 51–53, 63
- perl command, 91**
- phonebook file. See also rolo (Rolodex) program**
 - adding entries to, 125–127, 277
 - displaying entries from, 278–279
 - editing entries in, 281–283
 - listing entries in, 283–284
 - looking up entries in, 124–125, 278
 - removing entries from, 127–128, 280–281
- PIDs (process IDs), 37, 199**
- pipe symbol (|)**
 - || construct, 161–162
 - case command, 159–160
 - loops, 178–179
 - pipeline process, 33–34, 49, 321, 322

plus sign (+)

- job control, 315
- pattern matching, 63
- printf format specification modifier, 206

pointers to variables, 257**positional parameters**

- definition of, 239
- left-shifting, 128–129
- overview, 322
- reassigning values to, 239, 247–248
- setting, 350
- shifting left, 352
- substitution, 121–122

POSIX shell

- compatibility summary, 319–320
- overview, 1
- startup, 321
- subshell execution, 332
- vi line edit mode, 326–329
- Web documentation, 360

pound sign (#)

- comments, 96
- pattern matching, 243
- printf format specification modifier, 206

PPID variable, 324**prargs program, 169–170****precedence of operators, 330****precise number of subpatterns, matching, 59–61****precision modifier (printf), 205–206****printf command**

- example, 206–207
- format specification characters, 202–205
- format specification modifiers, 205–206
- syntax, 202

printing

- command information, 356

date/time, 5, 95–96

formatted output

- example, 206–207
- format specification characters, 202–205
- format specification modifiers, 205–206
- printf command syntax, 202

list of active jobs, 347

to working directory, 348

process IDs (PIDs), 37, 199**processes**

- definition of, 43
- parent/child, 257
- returning information about, 37
- waiting for completion
 - \$! variable, 257–258
 - wait command, 257

.profile file, 235–236**on program, 132–135, 145–147, 170–171****programs**

- add, 125–127, 277
- addi, 200
- args, 122–123
- arguments, passing
 - \$# variable, 122–123
 - \$* variable, 123–124
 - \${n} special variable, 128
- phonebook file example, 124–128
- positional parameters, 121–122
- shift command, 128–129
- cdtest, 225
- change, 281–283
- command files, 93–96
- comments, 96
- ctype, 155–156, 158–159

- db, 227–229
- debugging, 157–159
- display, 278–279
- execution, 45–47
- getty. *See* shells
- greetings, 149–151, 159–160
- init, 40–43
- ison, 122
- listall, 283–284
- lu, 124–125, 278
- mybasename, 244
- mycp
 - echo escape characters, 187–188
 - final code listing, 190–193
 - initial code listing, 185–187
 - revised code listing, 188–190
- number, 154–155
- number2, 253
- on, 132–135, 145–147, 170–171
- prags, 169–170
- rem, 147–148, 151–153, 280–281
- reverse, 311
- rolo (Rolodex)
 - \$\$ variable, 198–199
 - add program, 277
 - change program, 281–283
 - data formatting, 273–274
 - display program, 278–279
 - final code listing, 274–277
 - fun, 270–271
 - initial code listing, 193–194
 - listall program, 283–284
 - lu program, 278
 - PATH variable, 221–224
 - rem program, 280–281
 - revised code listing, 196–198
 - rolosubs file, 264–266
 - sample output, 284–287
 - sample runs, 195–196
 - temporary files, 198–199
- run, 95, 121, 164
- shar, 267
- shell variables
 - arithmetic expansion, 103–104
 - assigning values to, 97, 322, 333
 - definition of, 97
 - displaying values of, 98–100
 - exported variables, 332, 340–341
 - filename substitution, 101–103
 - HISTSIZE, 326
 - null values, 100–101
 - readonly variables, 349
 - table of, 323–324
 - undefined variables, 100–101
- stats, 95–96
- trace mode, turning on/off, 246
- twhile, 169
- vartest, 209
- vartest2, 210
- vartest3, 212
- vartest4, 213–214
- waitfor, 171–174, 180–184
- words, 249–250
- ps command, 37**
- PS1 variable, 216, 324**
- PS2 variable, 216, 324**
- PS4 variable, 324**
- pseudo-terminals, 40**
- pseudo-tty, 40**
- pwd command, 12, 95–96, 348**
- PWD variable, 324**

Q

question mark (?)

filename substitution, 25–27, 47, 331
 pattern matching, 242, 336

quote characters

back quote (`), 114–115
 backslash (\)
 escaping characters with,
 111–114
 inside double quotes, 112–114
 line continuation, 112
 overview, 111–112
 double quotes ("), 109–111
 overview, 329
 single quotes ('), 105–108
 smart quotes, 119

R

r command, 301–303**-r file operator, 142–143****race conditions, 199****read command**

exit status, 199–202
 menu-driven phone program (rolo)
 \$\$ variable, 198–199
 initial code listing, 193–194
 revised code listing, 196–198
 sample runs, 195–196
 temporary files, 198–199
 mycp program
 echo escape characters, 187–188
 final code listing, 190–193
 initial code listing, 185–187
 revised code listing, 188–190
 overview, 348–349
 syntax, 185

reading data

exit status, 199–202
 menu-driven phone program (rolo)
 \$\$ variable, 198–199
 initial code listing, 193–194
 revised code listing, 196–198
 sample runs, 195–196
 temporary files, 198–199

mycp program

echo escape characters, 187–188
 final code listing, 190–193
 initial code listing, 185–187
 revised code listing, 188–190

read command syntax, 185

readonly command, 254, 349**read-only variables, 254, 349****reassigning values to positional parameters,
239, 247–248****redirection (I/O)**

<&- construct, 262
 >&- construct, 262
 input redirection
 < (left arrow), 331
 exec command, 230–231, 262
 in-line input redirection, 262–267
 overview, 331
 POSIX shell, 331
 shell archive creation, 264–267
 standard I/O (input/output), 28–30
 loops, 177–178
 output redirection
 exec command, 230–231, 262
 overview, 30–32
 standard output, closing, 262
 overview, 48–49, 331–332
 POSIX shell, 331–332
 in programs, 94

- standard error, writing to, 261–262
 - standard I/O (input/output), 28–30
- redirection append (>>) characters, 31–32**
- re-entry of commands, 326**
- references**
 - books, 360–361
 - online documentation, 359
 - overview, 359
 - Web documentation, 360
- referencing jobs, 333–334**
- regex. See regular expressions**
- registering your book, 3**
- regular expressions**
 - [.] construct, 55–57
 - \(.\) construct, 61–63
 - \{.\} construct, 59–61
 - asterisk (*), 57–59
 - caret (^), 53
 - dollar sign (\$), 53–54
 - grep command, 81–82
 - overview, 51
 - period (.), 51–53
 - summary table, 61–63
- rem program, 147–148, 151–153, 280–281**
- removing**
 - aliases, 309
 - characters from input stream, 77–78
 - directories, 22–23
 - duplicate lines
 - sort command, 84
 - uniq command, 88–89
 - files, 9
 - function definitions, 271
 - lines, 73
 - phonebook file entries, 127–128, 280–281
- renaming files, 8–9**
- resetting traps, 261**
- resources**
 - books, 360–361
 - online documentation, 359
 - overview, 359
 - Web documentation, 360
- return command, 271, 349**
- reverse program, 311**
- reversing sort order, 85**
- Ritchie, Dennis, 1**
- rm command, 9**
- rmdir command, 22–23**
- rolo (Rolodex) program**
 - \$\$ variable, 198–199
 - add program, 277
 - change program, 281–283
 - data formatting, 273–274
 - display program, 278–279
 - final code listing, 274–277
 - functions, 270–271
 - initial code listing, 193–194
 - listall program, 283–284
 - lu program, 278
 - PATH variable, 221–224
 - rem program, 280–281
 - revised code listing, 196–198
 - rolosubs file, 264–266
 - sample output, 284–287
 - sample runs, 195–196
 - temporary files, 198–199
- Rolodex program. See rolo (Rolodex) program**
- rolosubs file, 264–266**
- run program, 95, 121, 164**
- running rolo program, 195–196**

S

-s file operator, 142–143

%s format specification character, 203

saving matched characters, 61–63

scanning command line twice before executing, 255–257

search order, 319

searching. See **pattern matching**

searching files with grep

-l option, 82–83

-n option, 83

overview, 78–81

regular expressions, 81–82

-v option, 82

sed command

d command, 73

examples, 73

-n option, 72

overview, 70–72

semicolon (;), 36, 179–180, 321

sending commands to background, 36–37

sequences of characters

double quotes ("), 109–111

single quotes ('), 105–108

set command

-- option, 248–250

IFS variable, 251–254

monitor option, 331

with no arguments, 247

overview, 239, 321, 350–351

positional parameters, reassigning, 247–248

-x option, 246

shar program, 267

shell archives, creating, 264–267

shell variables. See also **parameters**

arithmetic expansion, 103–104

assigning values to, 97, 322, 333

definition of, 97

displaying values of, 98–100

ENV, 290–291

exported variables, 211–216, 332, 340–341

filename substitution and, 101–103

finding number of characters stored in, 244

HISTSIZE, 326

HOME, 217

IFS, 251–254

listing, 247

local variables, 209–210, 303

null values, 100–101

passing to subshells, 234–235

PATH, 217–224

pointers, creating, 257

PS1, 216

PS2, 216

read-only variables, 254, 349

special variables

\$? variable, 132–135

#! variable, 257–258

\$# variable, 122–123

\$* variable, 123–124, 166

\$@ variable, 166–167

\${n} variable, 128

\$0 variable, 245

table of, 323–324

TERM, 236–237

TZ, 236–237

undefined variables, 100–101

unsetting, 254

shells

Bash. *See also* nonstandard shell features

compatibility summary, 319–320

history of, 289

Web documentation, 360

compatibility summary, 319–320

current shell, executing files in,
227–230

definition of, 1

Korn shell. *See also* nonstandard shell
features

compatibility summary, 319–320

history of, 289

Web documentation, 360

login shell, 40–43

POSIX shell. *See* POSIX shell

responsibilities of

environment control, 49

filename substitution, 47

interpreted programming
language, 50

I/O redirection, 48–49

overview, 44–45

pipelines, 49

program execution, 45–47

variable substitution, 47

specifying, 289–290

subshells

definition of, 43

environment, 210–211

overview, 227

terminating, 340

typing commands to, 43–44

shift command, 128–129, 352

signals

handling with trap command

execution with no arguments,
259–260

ignored signals, 260

overview, 258–259

signal numbers, 258

trap reset, 261

ignoring, 260

numbers, 355

single quotes ('), 105–108

skipping

commands in loops, 176–177

fields during sort, 87

smart quotes, 119

sort command

-k2n option, 87

-n option, 86

-o option, 85

other options, 88

overview, 84

-r option, 85

-t option, 87–88

-u option, 84

sorting lines

arithmetically, 86

delimiter characters, 87–88

duplicate lines, eliminating, 84

to output file, 85

overview, 84

reverse order, 85

skipped fields, 87

spaces in filenames, 27

sparse arrays, 310

special files, 6

special variables

\$? variable, 132–135

\$! variable, 257–258

\$# variable, 122–123

\$* variable, 123–124, 166

\$@ variable, 166–167

`#{n}` variable, 128

`$0` variable, 245

table of, 323–324

specifying shell, 289–290

standard error

overview, 35

writing to, 261–262

standard I/O (input/output)

closing, 262

deleting from input stream, 77–78

overview, 28–30

redirecting, 230–231

redirection, 261–262

translating characters from, 74–77

standard shell. See **POSIX shell**

starting up POSIX shell, 321

statements

`&&` construct, 161–162

`||` construct, 161–162

comments, 96

if

 elif construct, 148–151

 else construct, 145–147

 exit command, 147–148

 exit status, 131–135

 nesting, 148–149

 syntax, 131

 testing conditions in, 131–144

testing conditions in

 alternative format for test, 139–140

 file operators, 142–143

 integer operators, 140–142

 logical AND operator (`-a`), 143–144

 logical negation operator (`!`), 143

 logical OR operator (`-o`), 144

 overview, 135

 string operators, 135–139

stats program, 95–96

status, exit

`$?` variable, 132–135

definition of, 321

non-zero values, 131

overview, 131–132

zero values, 131

stopped jobs, 316–317, 334

storing values in variables, 97

stream editor (`sed`)

command overview, 70–72

`d` command, 73

examples, 73

`-n` option, 72

string operators, 135–139

subpatterns, matching, 59–61

subscripts, 309

subshells

`(.)` construct, 231–234

`{ ; }` construct, 231–234

definition of, 43

dot (`.`) command, 227–230

environment, 210–211

`exec` command, 227–230

execution, 332

overview, 227

passing variables to, 234–235

substitution

command substitution

`$()` construct, 115–118

 back quote (```), 114–115

 definition of, 112

`expr` command, 119–120

filename substitution

 asterisk (`*`), 24–25

 overview, 47

 POSIX shell, 331

- question mark (?), 25–27
- shell variables, 101–103
- parameter substitution
 - `${parameter}`, 239–240
 - `${parameter:+value}`, 242
 - `${parameter:=value}`, 241
 - `${parameter:-value}`, 240
 - `${parameter:?value}`, 241–242
- overview, 324–325
- pattern matching, 242–244
- positional parameters, 121–122
- tilde substitution, 318–319, 329
- variable substitution, 47, 98–100

suspending jobs, 316

symbolic links, 21–23

T

temporary files, 198–199

TERM, 236–237, 258

terminal, 28

terminating

- functions, 271
- jobs, 315
- loops, 336
- shell program, 340

test command

- alternative format, 139–140
- file operators, 142–143
- integer operators, 140–142
- logical AND operator (-a), 143–144
- logical negation operator (!), 143
- logical OR operator (-o), 144
- overview, 135, 352–354
- parentheses, 144
- string operators, 135–139
- syntax, 135

testing conditions in if statements

- alternative format, 139–140
- file operators, 142–143
- integer operators, 140–142
- logical AND operator (-a), 143–144
- logical negation operator (!), 143
- logical OR operator (-o), 144
- overview, 135
- parentheses, 144
- string operators, 135–139
- test command syntax, 135

text

- ASCII characters, octal values of, 75
- character sequences
 - double quotes ("), 109–111
 - single quotes ('), 105–108
- cutting, 64–66
- deleting
 - with sed, 73
 - with tr command, 77–78
- echoing, 6
- escaping, 111–112
- filenames
 - allowed characters, 6
 - special characters, 28
- line continuation, 112
- pasting, 68–70
- pattern matching
 - any character, 51–53
 - beginning of line, 53
 - character sets, 55–57
 - end of line, 53–54
 - filename substitution, 25–27
 - matched characters, saving, 61–63
 - parameter substitution, 242–244

- precise number of characters, 59–61
- zero or more characters, 57–59
- sorting, 84–88
- translating from standard input, 74–77
- Thompson, Ken, 1**
- tilde substitution, 318–319, 329**
- time**
 - printing, 5
 - time zone, determining, 237
- times command, 354, 355–356**
- tools.** See **commands**
- tr command**
 - d option, 77–78
 - examples, 78
 - octal values of ASCII characters, 75
 - overview, 74–76
 - s option, 76–77
- trace mode, turning on/off, 246**
- translating characters from standard input, 74–77**
- trap command**
 - execution with no arguments, 259–260
 - ignored signals, 260
 - overview, 258–259
 - signal numbers, 258
 - trap reset, 261
- Trojan horse, 218–219**
- true command, 356**
- turning on/off trace mode, 246**
- twhile program, 169**
- type command, 271**
- types, integer, 304–305**
- typing loops on one line, 179–180**
- TZ variable, 236–237**

U

- %u format specification character, 203**
- umask command, 356**
- unalias command, 309, 356**
- unary file operators, 142–143**
- unary logical negation operator (!), 143**
- undefined variables, 100–101**
- underscore (_), 322**
- uniq command**
 - c option, 90
 - d option, 89–90
 - overview, 88–89
- Unix**
 - development of, 1
 - resources
 - books, 360–361
 - online documentation, 359
 - overview, 359
 - Web documentation, 360
 - strengths of, 1
- unix.org website, 360**
- unset command, 254, 271, 357**
- until command, 170–174, 357**
- users, returning information about, 5–6**
- utilities, 39.** See *also* **commands**

V

- values**
 - assigning to variables, 97
 - reassigning to positional parameters, 239, 247–248
- variables (shell).** See *also* **parameters**
 - arithmetic expansion, 103–104
 - assigning values to, 97, 322, 333
 - definition of, 97
 - displaying values of, 98–100

ENV, 290–291

exported variables, 211–216, 332, 340–341

filename substitution, 101–103

finding number of characters stored in, 244

HISTSIZE, 326

HOME, 217

IFS, 251–254

listing, 247

local variables, 209–210, 303

null values, 100–101

passing to subshells, 234–235

PATH, 217–224

pointers, creating, 257

PS1, 216

PS2, 216

read-only variables, 254

readonly variables, 349

special variables

- \$? variable, 132–135
- #! variable, 257–258
- \$# variable, 122–123
- \$* variable, 123–124, 166
- @\$ variable, 166–167
- \${n} variable, 128
- \$0 variable, 245

substitution, 47, 98–100

table of, 323–324

TERM, 236–237

TZ, 236–237

undefined variables, 100–101

unsetting, 254

vartest program, 209

vartest2 program, 210

vartest3 program, 212

vartest4 program, 213–214

verbose shell mode, 351

vi line edit mode

- command history, accessing, 294–296
- overview, 292–294, 326–329, 351

W

-w file operator, 142–143

wait command, 257, 358

waitfor program, 171–174, 180–184, 232–234

waiting for job completion

- \$! variable, 257–258
- overview, 358
- wait command, 257

wc command, 7, 95–96

Web documentation, 360

Web Edition of book, 3

websites

- Cygwin, 360
- cygwin.com, 360
- Free Software Foundation, 360
- Korn shell, 360
- The Open Group, 360

while loops, 168–170, 358

whitespace, 45, 321

who command, 5–6

width modifier (printf), 205–206

words, counting, 7

words program, 249–250

working directory

- definition of, 10
- displaying, 12
- printing to, 348

writing to standard error, 261–262

X

-x file operator, 142–143
%X format specification character, 203
%x format specification character, 203
-x option, debugging with, 157–159
xtrace mode, 351

Y-Z

-z string operator, 137, 138
zero exit status, 131
zero or more characters, matching, 57–59

This page intentionally left blank

REGISTER



THIS PRODUCT

informit.com/register

Register the Addison-Wesley, Exam Cram, Prentice Hall, Que, and Sams products you own to unlock great benefits.

To begin the registration process, simply go to **informit.com/register** to sign in or create an account.

You will then be prompted to enter the 10- or 13-digit ISBN that appears on the back cover of your product.

Registering your products can unlock the following benefits:

- Access to supplemental content, including bonus chapters, source code, or project files.
- A coupon to be used on your next purchase.

Registration benefits vary by product. Benefits will be listed on your Account page under Registered Products.

About InformIT — THE TRUSTED TECHNOLOGY LEARNING SOURCE

INFORMIT IS HOME TO THE LEADING TECHNOLOGY PUBLISHING IMPRINTS Addison-Wesley Professional, Cisco Press, Exam Cram, IBM Press, Prentice Hall Professional, Que, and Sams. Here you will gain access to quality and trusted content and resources from the authors, creators, innovators, and leaders of technology. Whether you're looking for a book on a new technology, a helpful article, timely newsletters, or access to the Safari Books Online digital library, InformIT has a solution for you.

informIT.com

THE TRUSTED TECHNOLOGY LEARNING SOURCE

Addison-Wesley | Cisco Press | Exam Cram
IBM Press | Que | Prentice Hall | Sams

SAFARI BOOKS ONLINE



REGISTER YOUR PRODUCT at informit.com/register Access Additional Benefits and SAVE 35% on Your Next Purchase

- Download available product updates.
- Access bonus material when applicable.
- Receive exclusive offers on new editions and related products.
(Just check the box to hear from us when setting up your account.)
- Get a coupon for 35% for your next purchase, valid for 30 days. Your code will be available in your InformIT cart. (You will also find it in the Manage Codes section of your account page.)

Registration benefits vary by product. Benefits will be listed on your account page under Registered Products.

InformIT.com—The Trusted Technology Learning Source

InformIT is the online home of information technology brands at Pearson, the world's foremost education company. At InformIT.com you can

- Shop our books, eBooks, software, and video training.
- Take advantage of our special offers and promotions (informit.com/promotions).
- Sign up for special offers and content newsletters (informit.com/newsletters).
- Read free articles and blogs by information technology experts.
- Access thousands of free chapters and video lessons.

Connect with InformIT—Visit informit.com/community

Learn about InformIT community events and programs.



informIT.com
the trusted technology learning source

Addison-Wesley • Cisco Press • IBM Press • Microsoft Press • Pearson IT Certification • Prentice Hall • Que • Sams • VMware Press

Developer's Library

ESSENTIAL REFERENCES FOR PROGRAMMING PROFESSIONALS

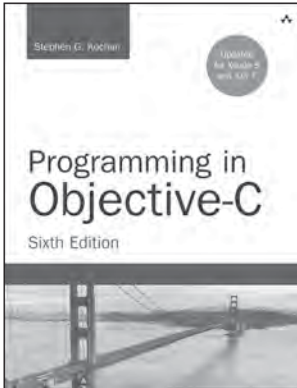

Programming in Objective-C, Sixth Edition

Stephen G. Kochan

ISBN-13: 978-0-321-96760-2

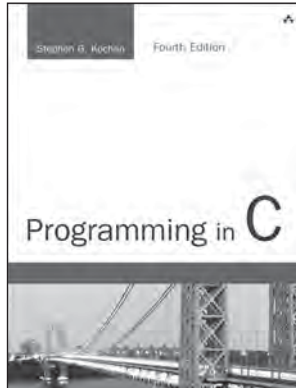

Programming in C, Fourth Edition

Stephen G. Kochan

ISBN-13: 978-0-321-77641-9

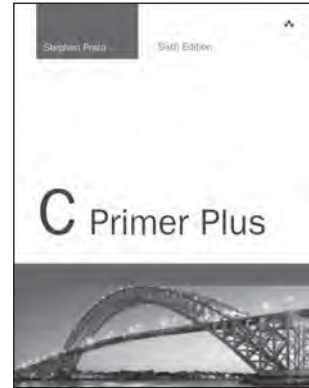

C Primer Plus, Sixth Edition

Stephen Prata

ISBN-13: 978-0-321-92842-9

Other Developer's Library Titles

TITLE	AUTHOR	ISBN-13
C++ Primer Plus, Sixth Edition	Stephen Prata	978-0-321-77640-2
Linux Kernel Development, Third Edition	Robert Love	978-0-672-32946-3
Linux Phrasebook, Second Edition	Scott Granneman	978-0-321-83388-4
Linux Shell Scripting with Bash	Ken O. Burtch	978-0-672-32642-4

Developer's Library books are available at most retail and online bookstores. For more information or to order direct, visit our online bookstore at informit.com/store

Online editions of all Developer's Library titles are available by subscription from Safari Books Online at safari.informit.com



Addison
Wesley

**Developer's
Library**

informit.com/devlibrary